

PROFITEST INTRO

Tester, DIN VDE 0100-600 / IEC 60364-6

3-349-840-03
5/1.19

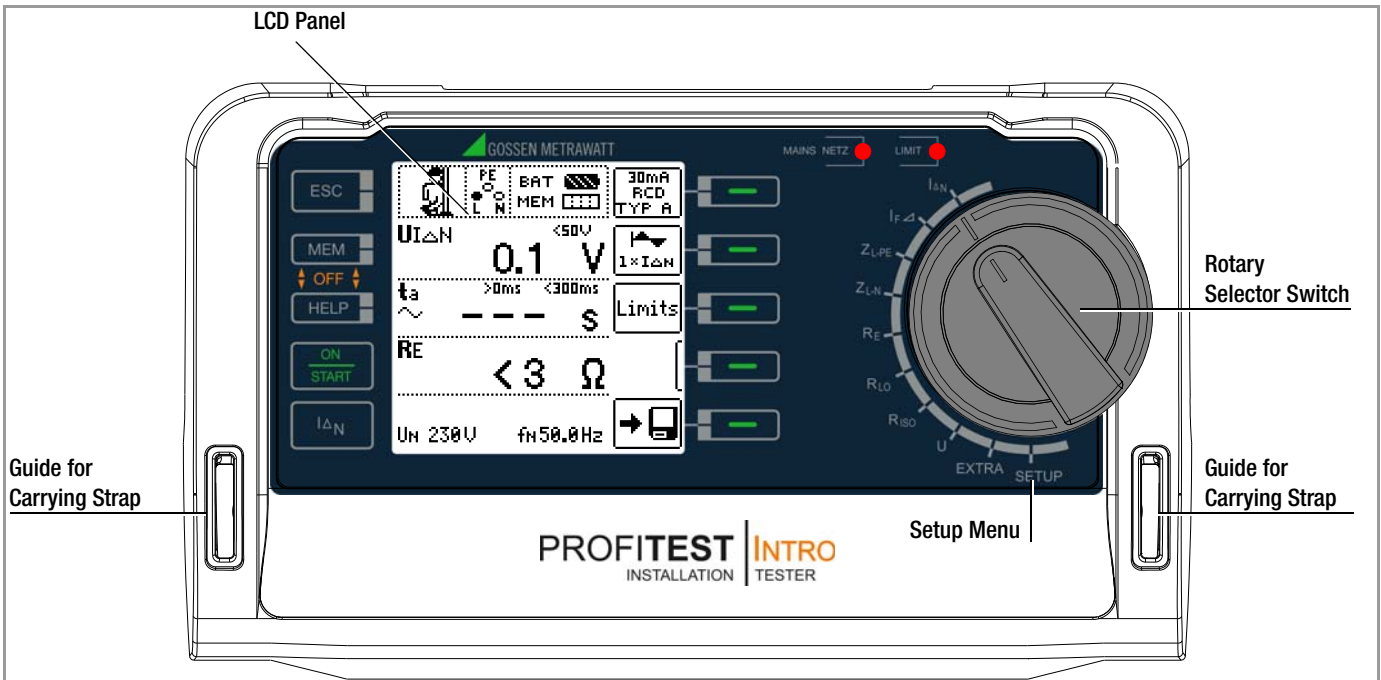



Control Panel

Softkeys

- Parameter selection
- Limit value specification
- Entry functions
- Memory functions

MAINS/NETZ LED
→ see below

Limit LED
→ see below

Fixed Function Keys

- ESC:** Return from submenu / Activate instrument from standby state
- MEM:** Key for memory functions
- HELP:** Access context sensitive help
- START:** Switch on / start measurement
- I_{ΔN}:** Triggering key / compensation (offset)

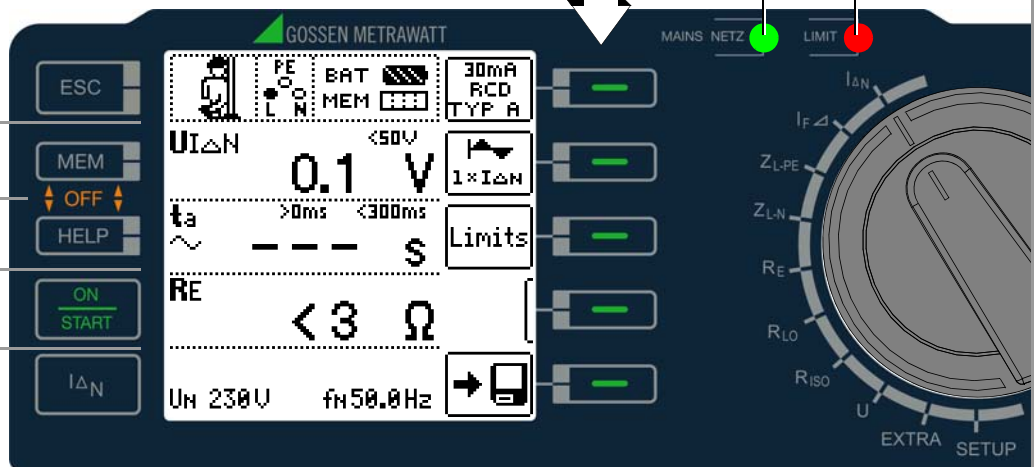

LED Indications (see also section 16)

LED Case A	LED Case B	LCD Case A	LCD Case B	Function – Cause
<p>Mains Green</p>	<p>Mains Blinks green</p>			<p>A Lights up green: Correct connection, measurement enabled</p> <p>B Blinks green: Neutral conductor not connected, measurement enabled</p>
<p>Mains Orange</p>	<p>Mains Blinks red</p>			<p>A Lights up orange: 2 different phases active (no neutral conductor at mains), meas. enabled</p> <p>B Blinks red: I_{ΔN}, I_{FΔ}, Z_{L-PE}, Z_{L-N}, R_E: No line voltage or PE interrupted</p> <p>C Lights up red: R_{INS} and R_{LO}: Interference voltage detected, measurement disabled</p>
<p>LIMIT Red</p>				<p>– U_{IΔ}, U_{IΔN}: Touch voltage > 25 or 50 V, measurement disabled: display: U_{IΔ}, U_{IΔN} > U_L!</p> <p>– I_{ΔN}: During the tripping test with I_N, the RCD is not tripped within 400 ms (1000 ms for selective RCCBs of type RCD S).</p> <p>– I_{FΔ}: With rising residual current, the RCD is not tripped before reaching I_N.</p> <p>– After safety shutdown</p> <p>– R_{LO}: The permissible (selected) limit value has been exceeded.</p> <p>– R_{INS}, R_E(INS): The permissible (selected) limit value has been exceeded.</p>

Batteries, Fuses

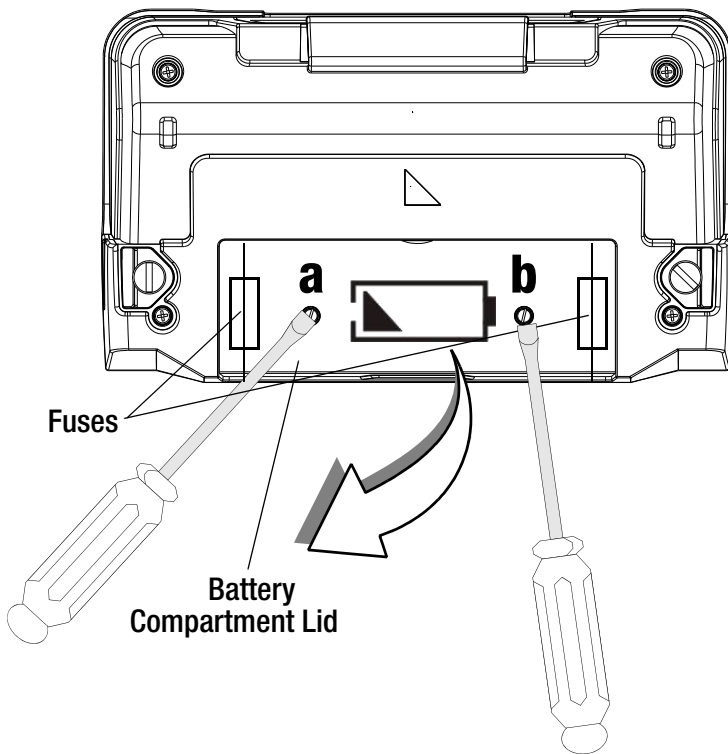

Inserting the Battery Holder (side view)

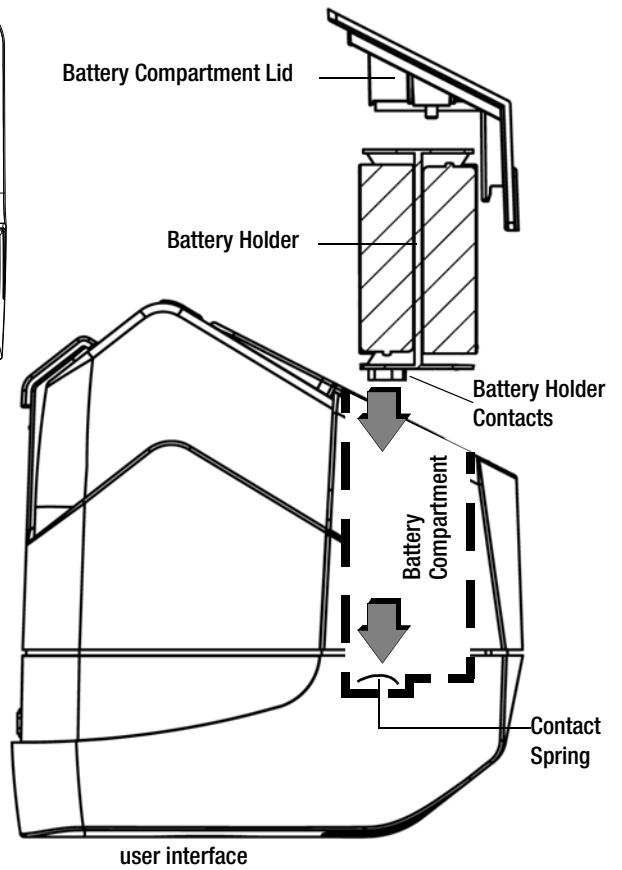

Measuring Connections

Test Probe with Remote Control, Option Z550A

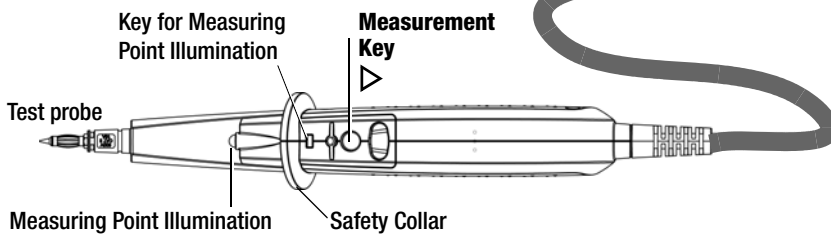

Assignment of Keys to Device or Remote Control

Measuring Function	At Device	Via Remote Control	At Device	Via Remote Control
	Start measurement		Tripping test	
IΔN				
IF Δ				
Measuring function	Start measurement		OFFSET	
ZL-PE, ZL-N				
RE				
RLO, ΔU				
RINS				

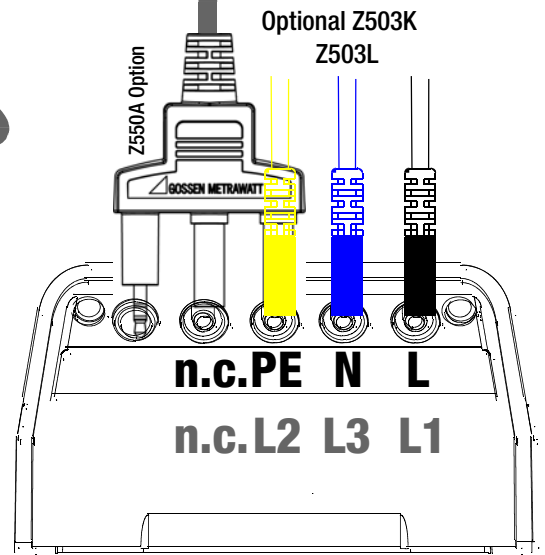

Charger Socket, Interfaces

These connections are located under a protective rubber flap.

Socket for Z502R charger

Caution!

Make sure no batteries are inserted before connecting the charger. The test instrument must remain off during the charging process.



Key

Display Panel

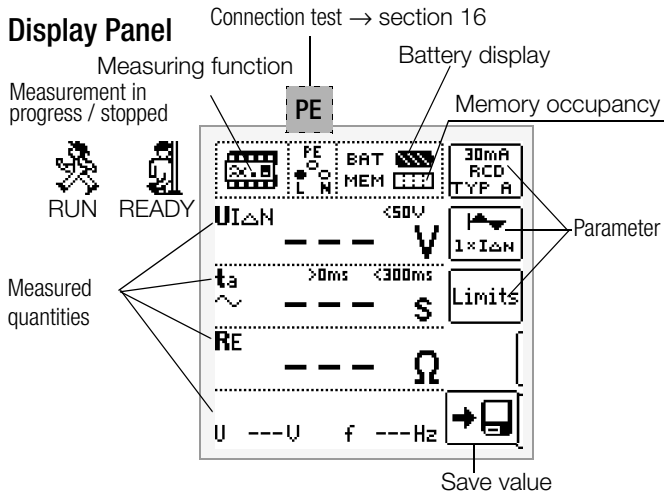

Battery Display

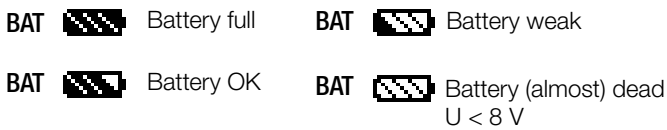

Memory Occupancy Display

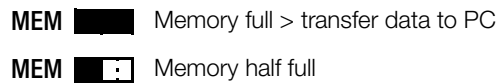

Connection Test – Mains Connection Test (→ section 16)

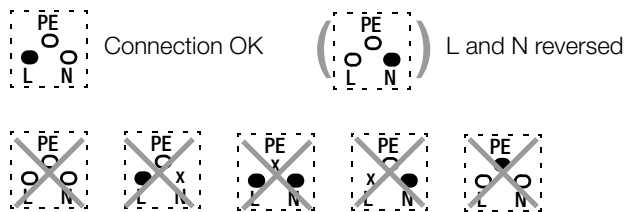

These operating instructions describe a tester with software version SW-VERSION (SW1) 01.20.00.

Overview of Device Settings and Measuring Functions

Switch Setting description as of	Pictograph	Device settings	Measuring Functions
SETUP page 9		SETTING Brightness, contrast, time/date Language (D, GB, P), profiles (ETC, PS3, PC.doc) Default settings < Test: LED, LCD, acoustic signal TESTS Battery test	
Measurements with Line Voltage			
U page 16		Single-phase measurement, U_{L-N-PE} U_{L-N} Voltage between L and N U_{L-PE} Voltage between L and PE U_{N-PE} Voltage between N and PE f Frequency 3-phase measurement $U_{3\sim}$ U_{L3-L1} Voltage between L3 and L1 U_{L1-L2} Voltage between L1 and L2 U_{L2-L3} Voltage between L2 and L3 f Frequency Phase sequence	Appears for all measurements shown below: U / U_N Line voltage / nominal line voltage f / f_N Line frequency / nominal line frequency
$U_{\Delta N}$ page 18		$U_{\Delta N}$ Touch voltage t_a Tripping time R_E Earth resistance	
I_{Δ} page 20		$U_{\Delta N}$ Touch voltage I_{Δ} Residual current R_E Earth resistance	
ZL-PE page 25		$ZL-PE$ Loop impedance I_K Short-circuit current	
ZL-N page 27		$ZL-N$ Line impedance I_K Short-circuit current	
R_E page 29		2-pole meas. (ground loop) $R_E(L-PE)$ 2-pole meas. / country-specific plug	
Measurements at voltage-free objects			
RLO page 35		RLO Low-resistance with polarity reversal $RLO+, RLO-$ Low-resistance, single-pole R_{OFFSET} Offset resistance	
RINS page 32		$RINS$ Insulation resistance $R_{E(INS)}$ Earth leakage resistance U Voltage at the test probes U_{INS} Test voltage Ramp: triggering/breakdown voltage	
EXTRA page 37		ΔU Voltage drop measurement	

1	Scope of Delivery	6	(R_E function)	29
2	Application	6	10.1 Earth Resistance, Mains Operation – 2-Pole Measurement with KS-PROFITEST INTRO or Country-Specific Measuring Adapter (Schuko) ..	30
2.1	Using Cable Sets and Test Probes	6		
2.2	Overview of Included Features	6	11 Measurement of Insulation Resistance	32
3	Safety Features and Precautions	7	11.1 General	32
4	Initial Start-Up	8	11.2 Special Case: Earth Leakage Resistance (REINS)	34
4.1	Installing or Replacing the Battery Pack	8	12 Measuring Low-Value Resistance up to 200 Ohm (protective conductor and equipotential bonding conductor)	35
4.2	Switching the Instrument On/Off	8	12.1 Measurement with Constant Test Current	36
4.3	(Rechargeable) Battery Test	8	13 Special Functions – EXTRA Switch Position	37
4.4	Charging the Battery Pack in the Tester	8	13.1 Voltage Drop Measurement (at ZLN) – Function ΔU	37
4.5	Device Settings	9	14 Database	38
5	General Notes	12	14.1 Creating Distributor Structures, General	38
5.1	Connecting the Instrument	12	14.2 Transferring Distributor Structures	38
5.2	Automatic Settings, Monitoring and Shut-Off	12	14.3 Creating a Distributor Structure in the Test Instrument	38
5.3	Measurement Value Display and Memory	13	14.3.1 Creating Structures (example for electrical circuit)	39
5.4	Testing Earthing Contact Sockets for Correct Connection	13	14.3.2 Searching for Structure Elements	40
5.5	Help Function	14	14.4 Saving Data and Generating Reports	41
5.6	Setting Parameters or Limit Values using RCD Measurement as an Example	14	14.4.1 Use of Barcode Scanners and RFID Readers	42
5.7	Freely Selectable Parameter Settings or Limit Values	15	15 Attaching the Test Probe Holder to the Carrying Strap	42
5.8	2-Pole Measurement with Fast or Semiautomatic Polarity Reversal	15	16 LED Indications, Mains Connections and Potential Differences	43
6	Measuring Voltage and Frequency	16	17 Characteristic Values	50
6.1	Single-Phase Measurement	16	17.1 Technical Data for Measurement Cables and Adapters	52
6.1.1	Voltage Between L and N (U_{L-N}), L and PE (U_{L-PE}) and N and PE (U_{N-PE}) with Country-Specific Measuring Adapter, e.g. SCHUKO	16	18 Maintenance	52
6.1.2	Voltage Between L – PE, N – PE and L – L with 2-Pole Connection	16	18.1 Firmware Revision and Calibration Information	52
6.2	3-Phase Measurement (line-to-line voltage) and Phase Sequence	17	18.2 Rechargeable Battery Operation and Charging	52
7	Testing RCDs	17	18.2.1 Charging Procedure with the Z502R Charger	52
7.1	Measuring Touch Voltage (with reference to nominal residual current) with $1/3$ Nominal Residual Current and Tripping Test with Nominal Residual Current	18	18.3 Fuses	53
7.2	Special Tests for Systems and RCDs	20	18.4 Housing	53
7.2.1	Testing Systems and RCCBs with Rising Residual Current (AC) for Type AC, A/F, B/B+ and EV, MI RCDs	20	19 Appendix	54
7.2.2	Testing Systems and RCCBs with Rising Residual Current (AC) for Type B/B+ and EV, MI RCDs	20	19.1 Tables for Determining Maximum or Minimum Display Values in Consideration of Maximum Measuring Uncertainty	54
7.2.3	Testing RCCBs with $5 \cdot I_{\Delta N}$	21	19.2 At which values should/must an RCD actually be tripped? Requirements for Residual Current Devices (RCDs)	56
7.2.4	Testing of RCCBs Pulsating DC Residual Current	21	19.3 Periodic Testing per DGUV Regulations 3 (formerly BGV A3) – Limit Values for Electrical Systems and Operating Equipment	57
7.3	Testing of Special RCDs	22	19.4 Optional Accessories (not included)	57
7.3.1	Systems with Type RCD-S Selective RCCBs	22	19.5 List of Abbreviations and their Meanings	58
7.3.2	PRCDs with Non-Linear Type PRCD-K Elements	22	19.6 Keyword Index	59
7.3.3	SRCD, PRCD-S (SCHUKOMAT, SIDOS or comparable)	23	19.7 Bibliography	60
7.3.4	Type G or R RCCB	24	19.7.1 Internet Addresses for Additional Information	60
7.4	Testing Residual Current Circuit Breakers in TN-S Systems	24	20 Repair and Replacement Parts Service Calibration Center and Rental Instrument Service	61
8	Testing of Breaking Requirements for Overcurrent Protective Devices, Measurement of Loop Impedance and Determination of Short-Circuit Current (functions Z_{L-PE} and I_K)	25	21 Recalibration	61
8.1	Measurements with Suppression of RCD Tripping	26	22 Product Support	61
8.1.1	Measurement with Positive Half-Waves	26		
8.2	Evaluation of Measured Values	26		
8.3	Settings for Calculating Short-Circuit Current – Parameter I_K	27		
9	Measuring Line Impedance (Z_{L-N} function)	27		
10	Earthing Resistance Measurement			

1 Scope of Delivery

- 1 Test instrument
- 1 Shoulder strap
- 1 Battery pack
- 1 KS-PROFITEST INTRO (Z503L)
- 1 Factory calibration certificate
- 1 Condensed operating instructions
- 1 Supplementary sheet with safety information
- 1 Comprehensive operating instructions available on the Internet for download at www.gossenmetrawatt.com

2 Application

This instrument fulfills the requirements of the applicable EU guidelines and national regulations. We confirm this with the CE mark. The relevant declaration of conformity can be obtained from GMC-I Messtechnik GmbH.

The measuring and test instrument allows for quick and efficient testing of protective measures in accordance with DIN VDE 0100-600:2008 (Erection of low-voltage installations; tests – initial tests), as well as ÖVE-EN 1 (Austria), NIV/NIN SEV 1000 (Switzerland) and other country-specific regulations.

The test instrument complies with IEC 61557/EN 61557/VDE 0413 regulations:

Part 1: General requirements

Part 2: Insulation resistance

Part 3: Loop resistance

Part 4: Resistance of earth connection and equipotential bonding

Part 5: Earth resistance

Part 6: Effectiveness of residual current devices (RCDs) in TT and TN systems

Part 7: Phase sequence

Part 10: Electrical safety in low-voltage systems up to 1000 V AC and 1500 V DC – Equipment for testing, measuring or monitoring of protective measures

The test instrument is especially well suited for:

- Systems setup
- Initial start-up
- Periodic testing
- Troubleshooting in electrical systems

All of the values required for approval reports (e.g. per ZVEH) can be measured with this test instrument.

All acquired data can be archived, and measurement and test reports can be printed out at a PC. This is of special significance where product liability is concerned.

The applications range of the test instrument covers all alternating and three-phase current systems with nominal voltages of 230 V / 400 V (300 V / 500 V) and nominal frequencies of 16% / 50 / 60 / 200 / 400 Hz.

The following can be measured and tested with the test instrument:

- Voltage / frequency / phase sequence
- Loop impedance / line impedance
- Residual current devices (RCDs)
- Earth resistance / earth loop resistance (relative to the mains)
- Insulation resistance
- Low-value resistance (potential equalization)
- Voltage drop

Refer to section 19.3 regarding testing of electrical machines in accordance with DIN EN 60204.

Refer to section 19.3 for periodic testing in accordance with DGUV regulation 3 (formerly BGV A3).

2.1 Using Cable Sets and Test Probes

- KS-PROFITEST INTRO (Z503L)
- Remote control with measurement key (Z550A), optional accessory

Measurements per DIN EN 61010-031 may only be performed in environments in accordance with measuring categories III and IV with the safety cap attached to the test probe at the end of the measurement cable.

In order to establish contact inside 4 mm jacks, the safety caps have to be removed by prying open the snap fastener with a pointed object (e.g. the other test probe).

See also section 17.1, "Technical Data for Measurement Cables and Adapters", beginning on page 52.

2.2 Overview of Included Features

PROFITEST INTRO (M520T)
Testing of residual current devices (RCDs)
U_B measurement without tripping the RCD
Tripping time measurement
Measurement of tripping current I_T
Selective, SRCDS, PRCDS, type G/R
AC/DC sensitive RCDs, types B and B+, EV, MI
Testing for N-PE reversal
Measurement of loop impedance Z_{L-PE} / Z_{L-N}
Fuse table for systems without RCDs
Without tripping the RCD, fuse table
With 15 mA test current ¹ , without tripping the RCD
Earth resistance R_E (mains operation)
Measurement of equipotential bonding R_{LO}
Automatic polarity reversal
Insulation resistance R_{INS}
Variable or rising test voltage (ramp)
Voltage $U_{L-N} / U_{L-PE} / U_{N-PE} / f$
Special measurements
Phase sequence
Earth leakage resistance $R_{E(INS)}$
Voltage drop (ΔU)
Features
Selectable user interface language ²
Memory (database for up to 50,000 objects)
RS 232 port for RFID/barcode reader
USB port for data transmission
ETC user PC software
Measuring category: CAT III 600 V / CAT IV 300 V
Factory calibration certificate

¹ The so-called live measurement is only advisable if there is no bias current within the system. Only suitable for motor protection switches with small nominal current values.

² Currently available languages: D, GB, I, F, E, P, NL, S, N, FIN, CZ, PL

3 Safety Features and Precautions

The electronic measuring and test instrument is manufactured and tested in accordance with safety regulations IEC 61010-1/EN 61010-1/VDE 0411-1.

Safety of the operator, as well as that of the instrument, is only assured when it's used for its intended purpose.

Read the operating instructions thoroughly and carefully before using your instrument. Follow all instructions contained therein. Make sure that the operating instructions are available to all users of the instrument.

Tests may only be executed by a qualified electrician.

The measuring and test instrument may not be placed into service:

- If the battery compartment lid has been removed
- If external damage is apparent
- If connector cables or measuring adapters are damaged
- If the instrument no longer functions flawlessly
- After a long period of storage under unfavorable conditions (e.g. humidity, dust or extreme temperature)

Exclusion of Liability

When testing systems with RCCBs, they may switch off. This may occur even though the test does not normally provide for it. Leakage currents may be present which, in combination with the test current of the test instrument, exceed the shutdown threshold value of the RCCB. PCs which are operated in proximity to such RCCB systems may switch off as a consequence. This may result in inadvertent loss of data. Before conducting the test, precautions should therefore be taken to ensure that all data and programs are adequately saved and the computer should be switched off, if necessary. The manufacturer of the test instrument assumes no liability for any direct or indirect damage to equipment, computers, peripheral equipment or data bases when performing the tests.

Opening the Instrument / Repairs

The instrument may only be opened by authorized, trained personnel in order to ensure flawless operation and to assure that the guarantee is not rendered null and void.

Even original replacement parts may only be installed by authorized, trained personnel.

If it can be ascertained that the instrument has been opened by unauthorized personnel, no guarantee claims can be honored by the manufacturer with regard to personal safety, measuring accuracy, compliance with applicable safety measures or any consequential damages.

If the guarantee seal is damaged or removed, all guarantee claims are rendered null and void.

Meanings of Symbols on the Instrument



Warning concerning a point of danger (attention, observe documentation!)



Protection class II device



Charging socket for extra-low direct voltage (Z502R charger)

Caution!

Only rechargeable NiMH batteries may be inserted when the charger is connected.



This device may not be disposed of with the trash. Further information regarding the WEEE mark can be accessed on the Internet at www.gossenmetrawatt.com by entering the search term "WEEE".



CE Conformity Marking



If the guarantee seal is damaged or removed, all guarantee claims are rendered null and void.

Data Backup

We advise you to regularly transfer your stored data to a PC in order to prevent potential loss of data in the test instrument.

We assume no responsibility for any data loss.

We recommend the following PC software program for data processing and management:

- ETC

4 Initial Start-Up

4.1 Installing or Replacing the Battery Pack



Attention!

Before opening the battery compartment, disconnect the instrument from the measuring circuit (mains) at all poles!



Note

See also section 18.2 on page 52 regarding the charging procedure for the Compact Master Battery Pack (Z502H) and concerning the Z502R charger.

If at all possible, use the Compact Master Battery Pack (Z502H) with sealed cells which is available as an accessory. This ensures that the complete set of rechargeable batteries is always replaced at the same time and that all batteries are inserted with correct polarity, in order to assure that they do not fail.

Only use commercially available rechargeable battery packs if they will be externally recharged. The quality of these packs cannot be checked and may result in overheating and thus deformation under unfavorable conditions (when charging them in the instrument).

Dispose of rechargeable battery packs or individual rechargeable batteries in an environmentally sound fashion when their service life has nearly expired (approx. 80% charging capacity).

- ⇨ Loosen the slotted screw for the rechargeable battery compartment lid on the back and remove the lid.
- ⇨ Remove the depleted rechargeable battery pack/holder.



Attention!

If the rechargeable battery holder is used:

Make sure that all of the batteries are inserted with correct polarity. If just one battery is inserted with reversed polarity, it will not be recognized by the instrument and may result in leakage from the batteries. Individual rechargeable batteries may only be recharged externally.

- ⇨ Insert the new rechargeable battery pack / loaded rechargeable battery holder into the rechargeable battery compartment. The holder can only be inserted in its proper position.
- ⇨ Replace the lid and retighten the screw.

4.2 Switching the Instrument On/Off

The test instrument is switched on by pressing the **ON/START** key. The menu which corresponds to the momentary selector switch position is displayed.

The instrument can be switched off manually by simultaneously pressing the **MEM** and **HELP** keys.

After the period of time selected in the **SETUP** menus has elapsed, the instrument is switched off automatically (see "Device Settings", section 4.5).

4.3 (Rechargeable) Battery Test

If (rechargeable) battery voltage has fallen below the allowable lower limit, the pictograph shown at the right appears. **BAT**  "Low Batt!!!" is also displayed along with a (rechargeable) battery symbol. The instrument does not function if the batteries have been depleted excessively, and no display appears.

4.4 Charging the Battery Pack in the Tester



Attention!

Use the Z502R charger in order to recharge the **Compact Master Battery Pack (Z502H)** in the test instrument.

Make sure that the following conditions have been fulfilled before connecting the charger to the charging socket:

- The Compact Master Battery Pack (Z502H) has been inserted, i.e. not a commercially available rechargeable battery pack, individual batteries or non-rechargeable batteries.
- The test instrument has been disconnected from the measuring circuit at all poles.
- The instrument must remain off during charging.

Refer to section 18.2.1 with regard to charging a rechargeable battery pack which has been inserted into the tester.

If the rechargeable batteries or battery pack have not been used or recharged for a lengthy period of time (> 1 month), thus resulting in excessive depletion:

Observe the charging sequence (indicated by LEDs at the charger) and initiate a second charging sequence if necessary (disconnect the charger from the mains and from the test instrument to this end, and then reconnect it).

Please note that the system clock stops in this case and must be set to the correct time after the instrument has been restarted.

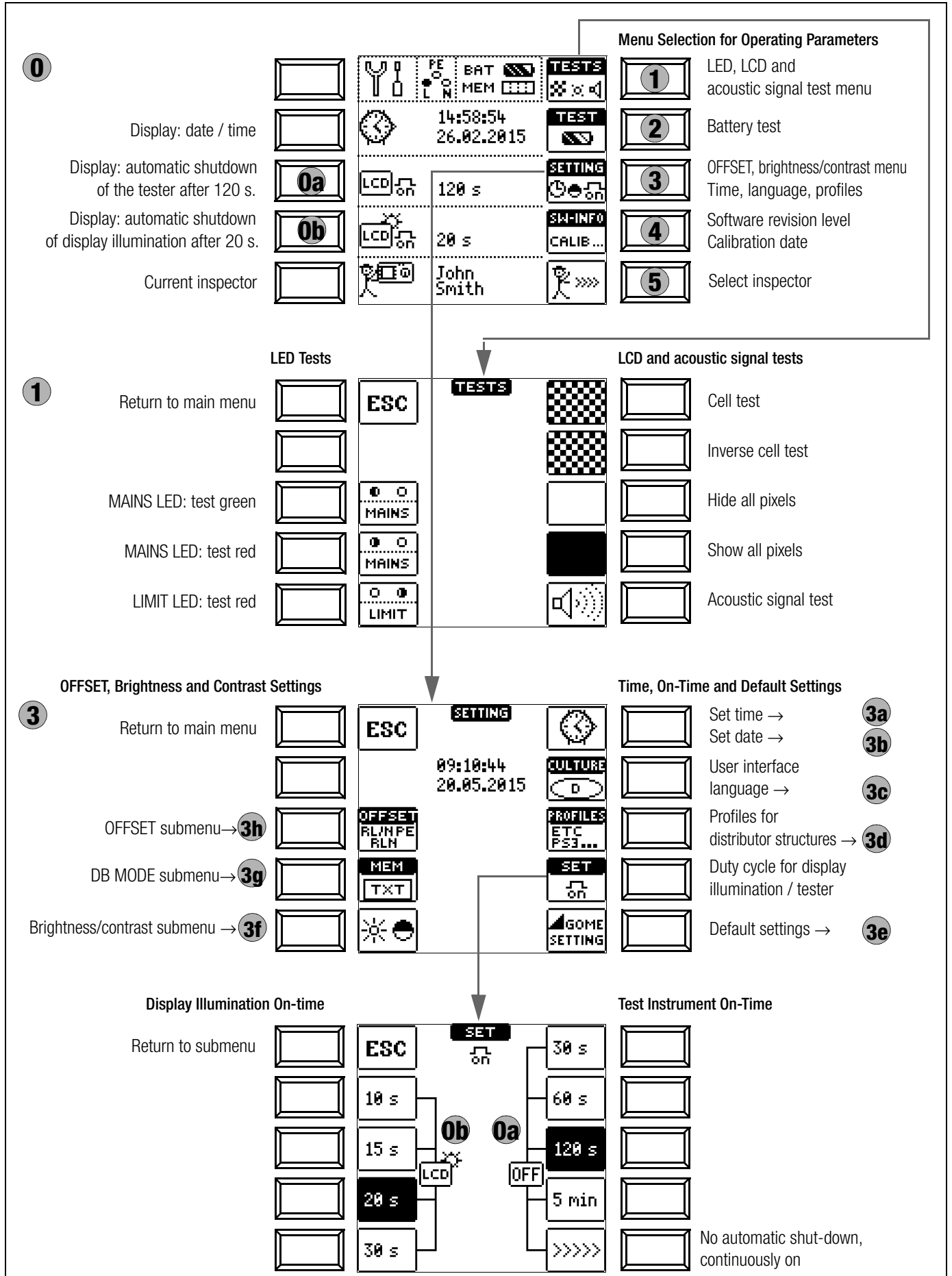

0

Display: date / time
 Display: automatic shutdown of the tester after 60 s.
 Display: automatic shutdown of display illumination after 15 s.
 Current inspector

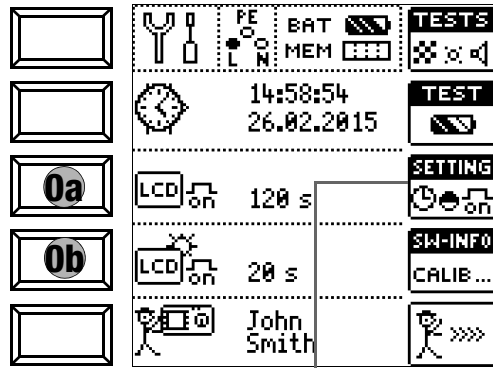

Menu Selection for Operating Parameters

- 1 LED and LCD test menu
- 2 Menu Battery test
- 3 Brightness/contrast menu Time, language, profiles
- 4 Software revision level Calibration date
- 5 Enter and select a new inspector (change/deletion via ETC only)

3

OFFSET, Brightness and Contrast Settings

Return to main menu

OFFSET submenu → 3h

DB MODE submenu → 3g

Brightness/contrast submenu → 3f

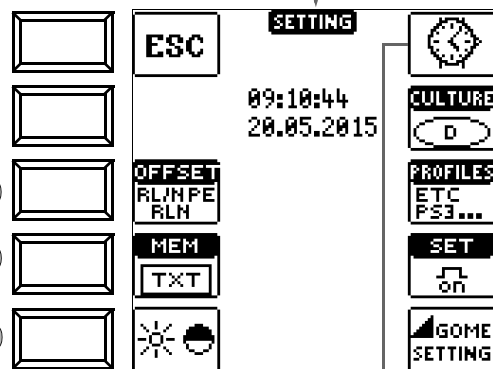

Set Time, Language, Profiles, Acoustic Signal

- Set time → 3a
- Set date → 3b
- Language for language → 3c
- Profiles for distributor structures → 3d
- Duty cycle for display illumination / tester
- Default settings → 3e

3a

Return to submenu

Decrease hours
 Decrease minutes
 Decrease seconds

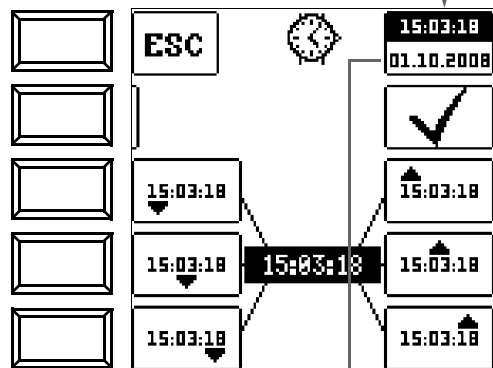

Set Time

- Set time
- Accept settings
- Increase hours
- Increase minutes
- Increase seconds

3b

Return to submenu

Decrease Day
 Decrease Month
 Decrease Year

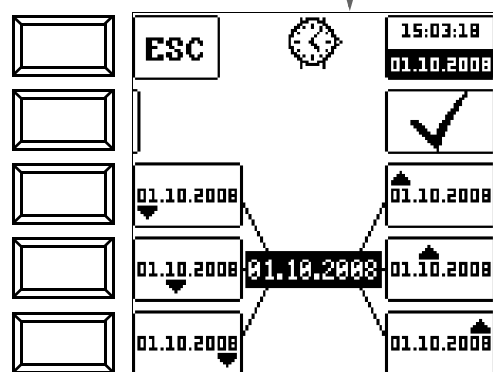

Set Date

- Set date
- Accept settings
- Increase Day
- Increase Month
- Increase Year

Significance of Individual Parameters

0a Test Instrument On-Time

The period of time after which the test instrument is automatically shut off can be selected here. This selection has a considerable influence on the service life and the charging status of the batteries.

0b LCD Illumination On-Time

The period of time after which LCD illumination is automatically shut off can be selected here. This selection has a considerable influence on the service life and the charging status of the batteries.

Submenu: (Rechargeable) Battery Level Query

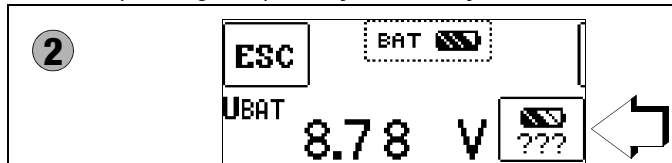

If (rechargeable) battery voltage has dropped to 8.0 V or less, the **LIMIT LED** lights up red and an acoustic signal is generated as well.



Note

Measuring Sequence

If (rechargeable) battery voltage drops to below 8.0 V during the course of a measuring sequence, this is only indicated by means of a pop-up window. Measured values are invalid. The measurement results cannot be saved to memory.



➤ Press **ESC** in order to return to the main menu.



Attention!

Data, including sequences, are lost when the language, the profile or the DB MODE is changed, or if the instrument is reset to default values!

Back up your structures and measurement data to a PC before pressing the respective key.

The prompt window shown at the right asks you to confirm deletion.



3c User Interface Language (CULTURE)

➤ Select the desired country setup with the appropriate country code.

Caution: All structures and data will be deleted (see note above)!

3d Profiles for Distributor Structures (PROFILES)

The profiles are laid out in a tree structure. The tree structure for the utilized PC evaluation program may differ from that of the **PROFITEST INTRO**. For this reason, the **PROFITEST INTRO** provides the user with the opportunity of adapting this structure.

Selecting a suitable profile determines which object combinations are made possible. For example, this makes it possible to create a distributor which is subordinate to another, or to save a measurement to a given building.

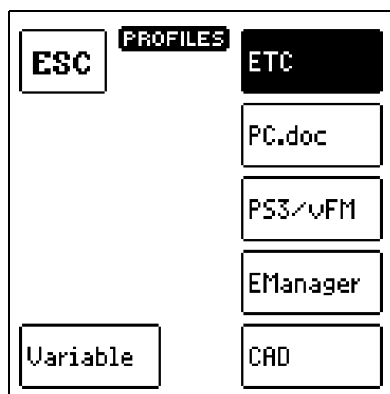

➤ Select the PC evaluation program you intend to use.
Caution: All structures and data will be deleted (see note above)!

If you have not selected a suitable PC evaluation program and, for example, if measured value storage to the selected location within the structure is not possible, the pop-up window shown at the right appears.

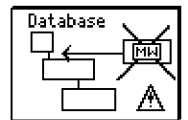

3e Default Settings (GOME SETTING)

The test instrument is returned to its original default settings when this key is activated.

Caution: All structures and data will be deleted (see note above)!

3f Adjust Brightness and Contrast

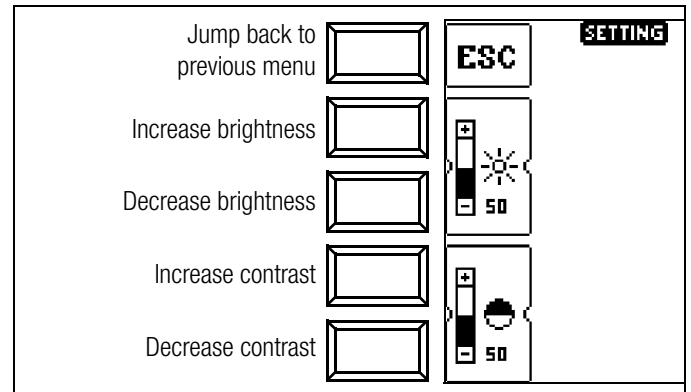

3g DB MODE – Database Representation in Text or ID Mode

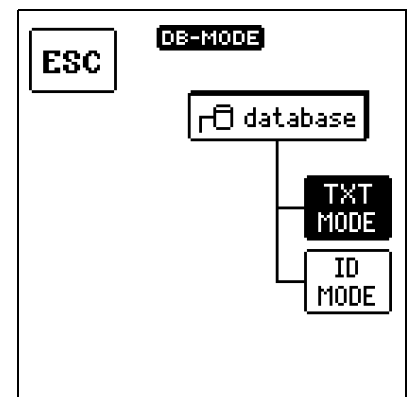

Creating Structures in the TXT MODE

The database in the test instrument is set to the text mode as a default feature and "TXT" appears in the header. You can create structure elements in the test instrument and label them in plain text, e.g. Customer XY, Distributor XY and Circuit XY.

Creating Structures in the ID MODE

You can work in the ID MODE as an alternative, in which case "ID" appears in the header. You can create the structure elements in the test instrument and label them with any desired ID numbers.



Note

When transferring data from the test instrument to ETC at a PC, ETC always uses the same representation as the test instrument (TXT or ID mode).

When transferring data from ETC at the PC to the test instrument, the test instrument always uses the same representation as ETC.

In other words, the respective data recipient always uses the same representation as the data transmitter.



Note

Structures can be created in the test instrument in either the text mode or the ID mode.

In contrast, designations and ID numbers are always assigned in ETC.

If no texts or ID numbers have been entered to the test instrument when creating structures, ETC generates the missing entries automatically. These can then be edited in ETC and transferred back to the test instrument if required.

3h OFFSET R_{L-PE} / R_{N-PE} / R_{L-N}

For the measurement of Z_{L-PE} , Z_{L-N} , RE and $\Delta U(Z_{LN})$, ohmic offset values R_{L-PE} , R_{N-PE} and R_{L-N} can be ascertained here, which then appear in the footers of the corresponding measuring menu pages and are subtracted from the measured values.

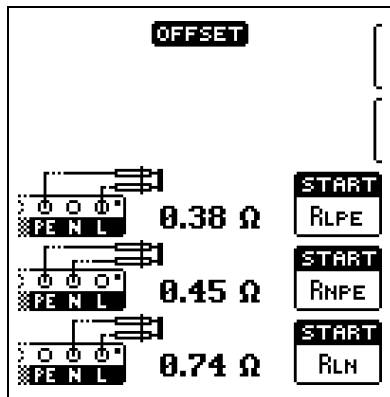

⇒ Connect the measurement cables to the respective inputs and short circuit the test probes by inserting the test plug into the short-circuiting jumper (PRO-JUMPER, Z503J).

⇒ Start offset measurement by pressing the respective **START** key.

The respective offset value cannot be activated or deactivated, i.e. set to 0, unless all settings are returned to their default values. There's a separate offset value for **RLO**, which can be ascertained directly in the **RLO** switch position.

Note

MEASUREMENT OF R_{L-PE} OR R_{N-P}

In the event that phase voltage might be applied to L or N at the test probe or the measuring adapter during future measurements, both offset values must be correspondingly determined. Depending on the connection, the corresponding offset value is then displayed later in the measuring menu. If no phase voltage is applied, **R_{L-PE}** appears as a standard display

Note

In order to ascertain the R_{LN} -OFFSET value for measurement of $\Delta U(Z_{LN})$:

Connect the test probe to the point of common coupling (measuring device / meter).

Firmware Revision and Calibration Information (example)

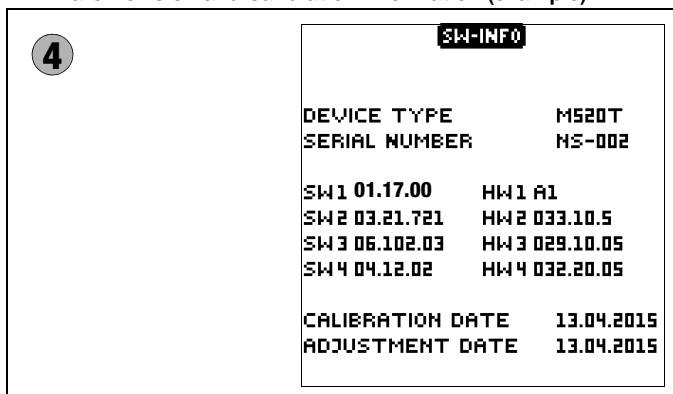

⇒ Press any key in order to return to the main menu.

Firmware Update with the MASTER Updater

The layout of the test instruments makes it possible to adapt device software to the latest standards and regulations. Beyond this, suggestions from customers result in continuous improvement of test instrument software, as well as new functions.

In order to assure that you can take advantage of all of these benefits without delay, the MASTER Updater allows you to quickly and completely update your test instrument software on-site.

The user interface can be set to either English, German or Italian.

Note

As a registered user, you're entitled to download the MASTER Updater and the current firmware version free of charge from the **myGMC** page.

5 Enter and Select a New Inspector

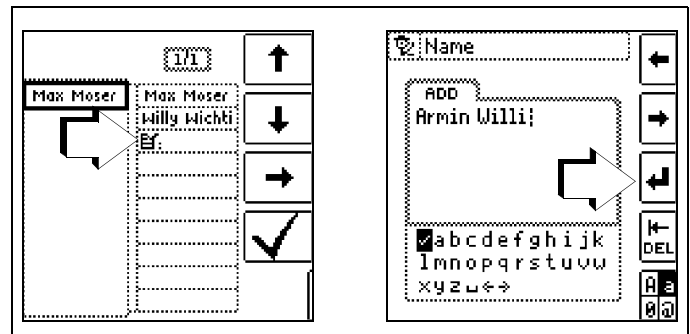

See also section 5.7 on page 15 regarding the entry of a text.

5 General Notes

5.1 Connecting the Instrument

For systems with earthing contact sockets, connect the instrument to the mains with the KS-PROFITEST INTRO test probes (Z503L) or with the PRO-Schuko measuring adapter (Z503K). Voltage between phase conductor L and the PE protective conductor may not exceed 253 V!

Poling at the socket need not be taken into consideration. The instrument detects the positions of phase conductor L and neutral conductor N and automatically reverses polarity if necessary. This does not apply to the following measurements:

- Voltage measurement in switch position U
- Insulation resistance measurement
- Low-resistance measurement

If measurement is to be performed at three-phase outlets, in distribution cabinets or at permanent connections, use the cable set with KS-PROFITEST INTRO test probes (Z503L) (2-pole), and for phase sequence testing (3-pole). Connection is established with the test probes: one at PE or N and the other at L.

5.2 Automatic Settings, Monitoring and Shut-Off

The test instrument automatically selects all operating conditions which it's capable of determining itself. It tests line voltage and frequency. If these lie within their valid nominal ranges, they appear at the display panel. If they are not within nominal ranges, prevailing voltage (U) and frequency (f) are displayed instead of U_N and f_N .

Measurement of Touch Voltage via Finger Contact

When a measurement is started and if you touch the **ON/START** key with your finger, the test instrument detects whether or not dangerous touch voltage **U_b** is present at the PE terminal relative to ground.

Error in the U Switch Position:

PE appears and the **LIMIT LED** lights up red.

Error in All Switch Positions Other than U:

The test instrument disables the measurement and the following message appears: **U.PE > UL!**

Prerequisites for reliable finger contact measurement:

- 1 Nothing is plugged into the interfaces and the charging cable is not plugged in.
- 2 Based on his standing surface, the user has an earth resistance of $R_{eb} < 1 \text{ M}\Omega$.
- 3 While starting the measurement, the user touches the “**ON/START**” key with the full surface of an unprotected finger with direct skin contact.

Insufficient Supply Voltage

If (**rechargeable**) **battery voltage** falls below the allowable limit value the instrument cannot be switched on, or it is immediately switched off.

Conditions Resulting in Disabling and Abortion of Measurements

The measurement is interrupted automatically or the measuring sequence is blocked (except for voltage measuring ranges and phase sequence testing) in the event of:

- Impermissible line voltages ($< 60 \text{ V}$, $> 253 \text{ V}$ / $> 330 \text{ V}$ / $> 440 \text{ V}$ or $> 550 \text{ V}$) for measurements which require line voltage
- Interference voltage during insulation resistance or low resistance measurements
- Overheating at the instrument.
As a rule, excessive temperatures only occur after approximately 50 measurement sequences at intervals of 5 seconds, when the rotary selector switch is set to the Z_{L-PE} or Z_{L-N} position.
If an attempt is made to start a measuring sequence, an appropriate message appears at the display panel.

Automatic Instrument Shutdown

The instrument only switches itself off automatically after completion of an automatic measuring sequence, and after the predetermined on-time has expired (see section 4.2). On-time is reset to its original value as defined in the setup menu as soon as any key or the rotary selector switch is activated.

The instrument remains on for approximately 75 seconds in addition to the preset on-time for measurements with rising residual current in systems with selective RCCDs.

The instrument always shuts itself off automatically, unless the following setting has been selected in SETUP: “>>>>>” (continuous on).

5.3 Measurement Value Display and Memory

The following items appear at the display panel:

- Measured values with abbreviations and units of measure
- Selected function
- Nominal voltage
- Nominal frequency
- Error messages

Measurement values for automatic measuring sequences are stored and displayed as digital values until the next measurement sequence is started, or until automatic shut-off occurs. If the upper range limit is exceeded, the upper limit value is displayed and is preceded by the “>” symbol (greater than), which indicates measurement value overrun.



Note

The depiction of LEDs in these operating instructions may vary from the LEDs on the actual instrument due to product improvements.

5.4 Testing Earthing Contact Sockets for Correct Connection

The testing of earthing contact sockets for correct connection prior to protective measures testing is simplified by means of the instrument's error detection system.

The instrument indicates improper connection as follows:

- **Non-allowable line voltage (< 60 V or > 253 V):**
The **MAINS/NETZ LED** blinks red and the measuring sequence is disabled.
- **Protective conductor not connected or potential to earth $\geq 50 \text{ V}$ at $\geq 50 \text{ Hz}$ (switch position U – single-phase measurement):**
If the contact surface of the **START** key is touched (**finger contact**) while PE is being contacted (via the country-specific measuring adapter, e.g. Z503K PRO-Schuko measuring adapter as well as via the test probe in the case of 2-pole measurement with the Z503L KS-PROFITEST INTRO), PE appears (only after starting the test sequence). The **MAINS LED** blinks red as well.
- **Neutral conductor N not connected** (during mains dependent measurements):
The **MAINS/NETZ LED** blinks green
- **One of the two protective contacts is not connected:**
This is checked automatically during testing for touch current $U_{\Delta N}$. Poor contact resistance at one of the contacts leads to one of the following displays depending upon the polarity of the plug:
 - **Display in the connection pictograph:**
PE interrupted (x), or bottom protective conductor tab interrupted with reference to the keys at the test plug
Cause: voltage measuring path interrupted
Consequence: measurement is disabled
 - **Display in the connection pictograph:**
Top protective conductor tab interrupted with reference to the keys at the test plug
Cause: current measuring path interrupted
Result: no measured value display

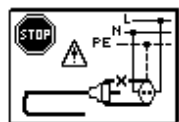
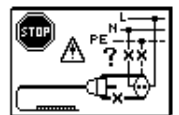

Note

See also “LED Indications, Mains Connections and Potential Differences” beginning on page 43.



Attention!

Reversal of N and PE in a system without RCCBs cannot be detected and is not indicated by the instrument. In a system including an RCCB, the RCCB is tripped during “touch voltage measurement without RCCB tripping” (automatic Z_{L-N} measurement), insofar as N and PE are reversed.

5.5 Help Function

The following information can be displayed for each switch position and basic function **after it has been selected with the rotary selector switch**:

- Wiring diagram
- Measuring range
- Nominal range of use and measuring uncertainty
- Nominal value

HELP

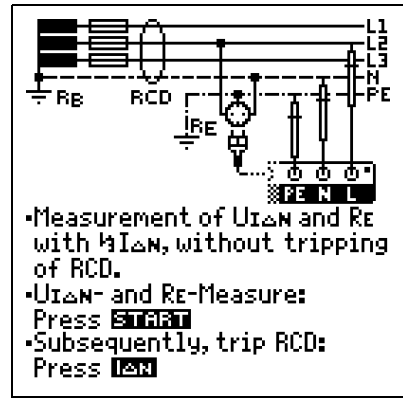

- Press the **HELP** key in order to query online help.
- If several pages of help are available for the respective measuring function, the **HELP** key must be pressed repeatedly.
- Press the **ESC** key in order to exit online help.

5.6 Setting Parameters or Limit Values using RCD Measurement as an Example

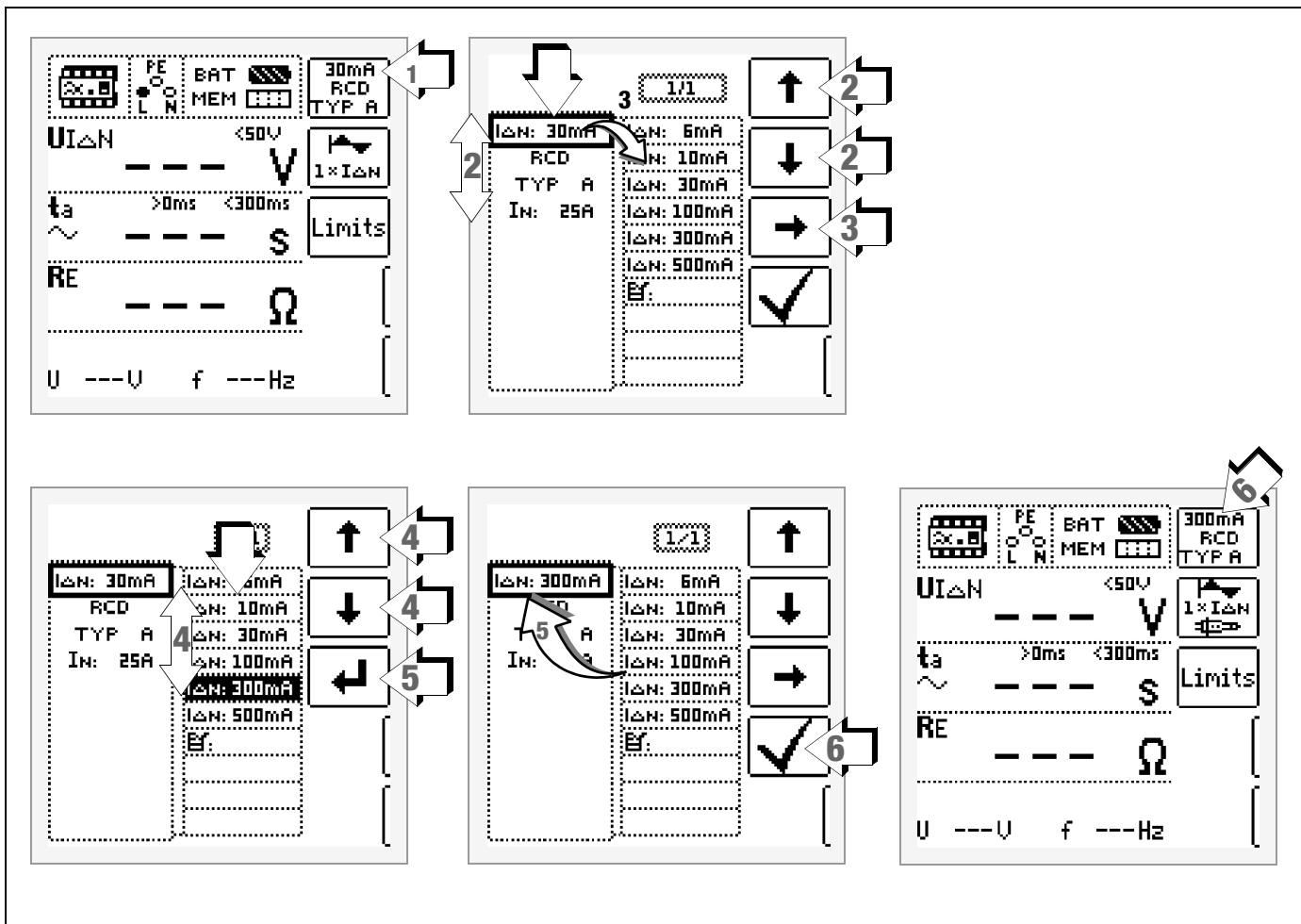

- 1 Access the submenu for setting the desired parameter.
- 2 Select a parameter using the \uparrow or \downarrow scroll key.
- 3 Switch to the setting menu for the selected parameter with the \rightarrow scroll key.
- 4 Select a setting value using the \uparrow or \downarrow scroll key.
- 5 Acknowledge the setting value with the \swarrow key. This value is transferred to the setting menu.
- 6 The setting value is not permanently accepted for the respective measurement until \checkmark is pressed, after which the display is returned to the main menu. You can return to the main menu by pressing **ESC** instead of \checkmark , without accepting the newly selected value.

Parameter Lock (plausibility check)

Individually selected parameter settings are checked for plausibility before transfer to the measurement window.

If you select a parameter setting which doesn't make sense in combination with other parameter settings which have already been entered, it's not accepted. The previously selected parameter setting remains unchanged.

Remedy: Select another parameter setting.

5.7 Freely Selectable Parameter Settings or Limit Values

In addition to fixed values, other values can be freely selected within predefined limits for certain parameters, if the symbol for the EDIT menu (3) appears at the end of the list of setting values.

Freely Selecting a Limit Value or Nominal Voltage

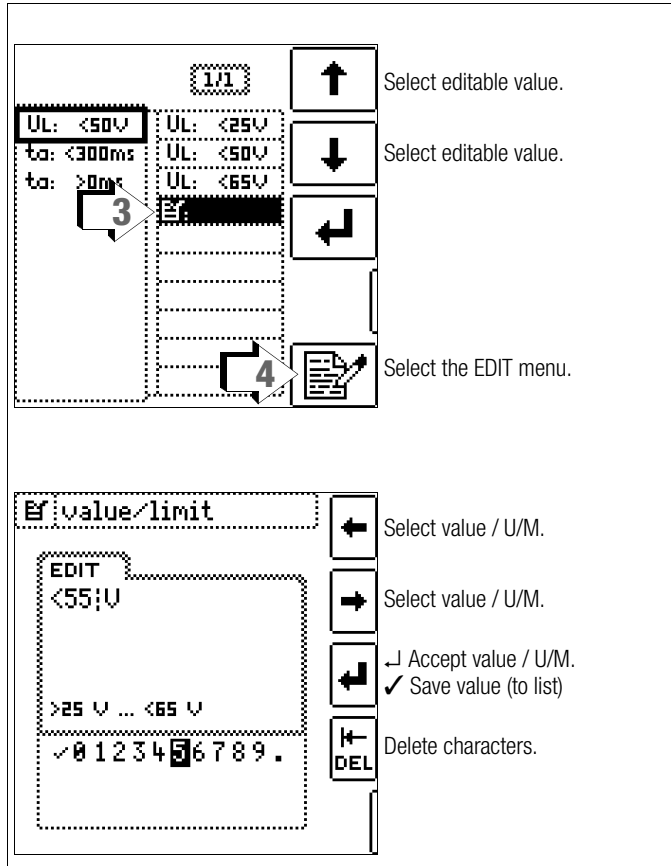

- 1 Open the submenu for setting the desired parameter (no figure, see section 5.6).
- 2 Select parameter (U_L) using the \uparrow or \downarrow scroll key (no figure, see section 5.6).
- 3 Select a setting value with the help of the EDIT icon and the \uparrow or \downarrow scroll key.
- 4 Select the edit menu: Press the key with the EDIT icon.
- 5 Select the desired value or unit of measure with the LEFT or RIGHT scroll key. The value or unit of measure is accepted by pressing the \downarrow key. The entire value is acknowledged by selecting \checkmark and then pressing the \downarrow key. The new limit value or nominal value is added to the list.

Note

Observe the predefined limits for the new setting value. New, freely selected limit values or nominal values included in the parameters list can be deleted/edited at the PC with the help of ETC software. If the upper limit value is exceeded, this limit value is used (65 V in the example), and if the lower limit value is fallen short of, it's used (25 V).

5.8 2-Pole Measurement with Fast or Semiautomatic Polarity Reversal

Fast, semiautomatic polarity reversal is possible for the following measurements:

- Voltage measurement (U)
- Loop impedance measurement Z_{L-PE}
- Internal line resistance measurement Z_{L-N}
- Insulation resistance measurement – RINS

Fast Polarity Reversal

The polarity parameter is set to AUTO.

Fast and convenient switching amongst all polarity variants, or switching to the parameter settings submenu, is possible by pressing the Δ_N key at the instrument.

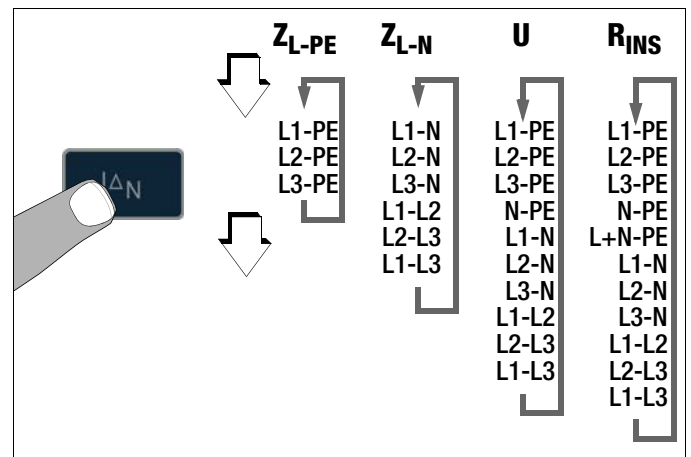
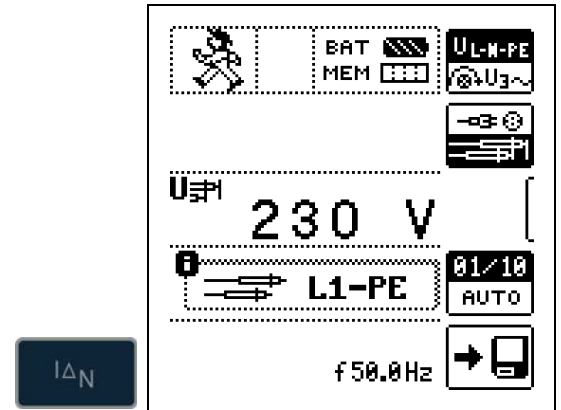

Semiautomatic Polarity Reversal in Memory Mode

The polarity parameter is set to AUTO.

If testing is to be conducted with all polarity variants, automatic polarity changing takes place after each measurement after saving.

Polarity variants can be skipped by pressing the Δ_N key at the instrument.

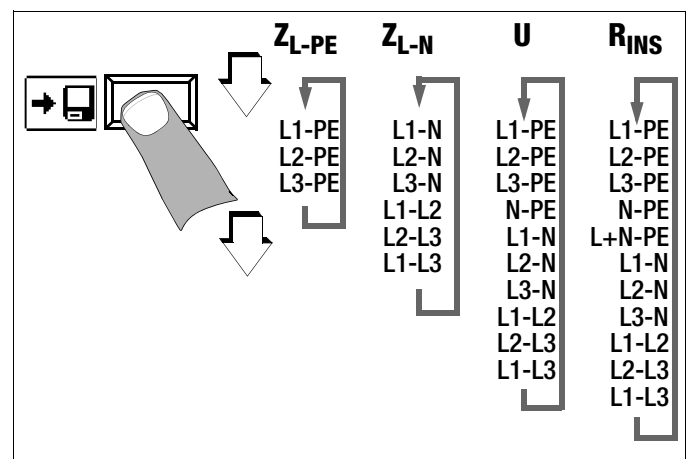

6 Measuring Voltage and Frequency

Select the Measuring Function

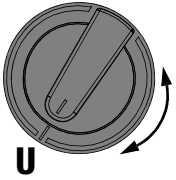

Switching Back and Forth Between Single and 3-Phase Measurement



Press the softkey shown at the left in order to switch back and forth between single and 3-phase measurement. The selected phase measurement is displayed inversely (white on black).

6.1 Single-Phase Measurement

Connection

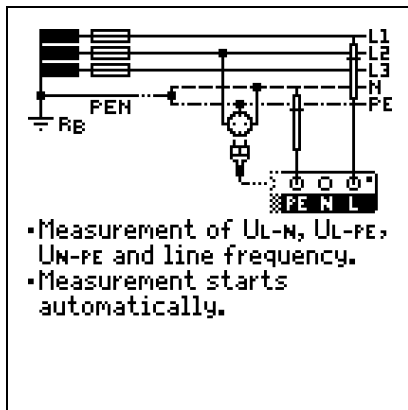

6.1.1 Voltage Between L and N (U_{L-N}), L and PE (U_{L-PE}) and N and PE (U_{N-PE}) with Country-Specific Measuring Adapter, e.g. SCHUKO



Press the softkey shown at the left in order to switch back and forth between the country-specific measuring adapter, e.g. **PRO-Schuko measuring adapter** (Z503K), and 2-pole measurement with the **KS-PROFITEST INTRO** (Z503L). The selected connection type is displayed inversely (white on black).

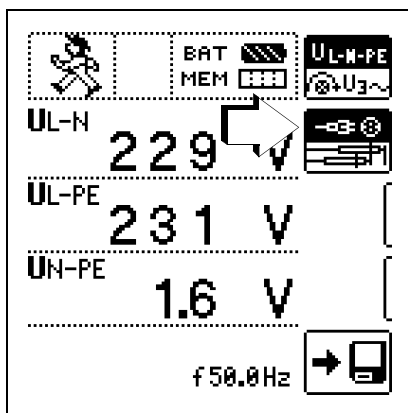

6.1.2 Voltage Between L – PE, N – PE and L – L with 2-Pole Connection



Press the softkey shown at the left in order to switch back and forth between the country-specific measuring adapter, e.g. **PRO-Schuko measuring adapter** (Z503K), and 2-pole measurement with the **KS-PROFITEST INTRO** (Z503L). The selected connection type is displayed inversely (white on black).

Refer to section 5.8 regarding 2-pole measurement with fast or semiautomatic polarity reversal.

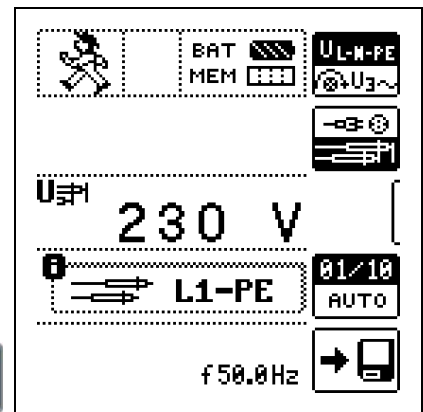
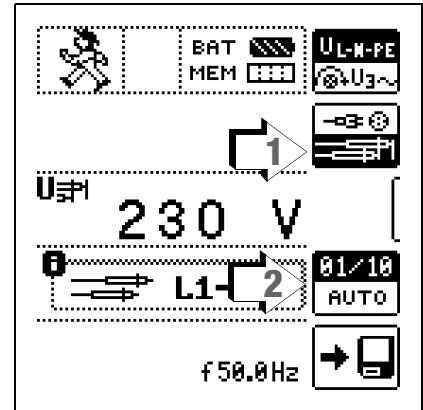

6.2 3-Phase Measurement (line-to-line voltage) and Phase Sequence

Connection

The included measurement cables (Z503L) are required in order to connect the instrument.

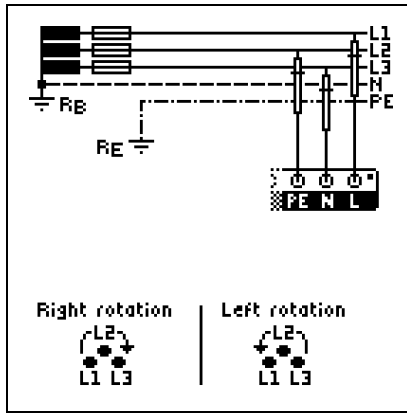

⇒ Press softkey U3~.

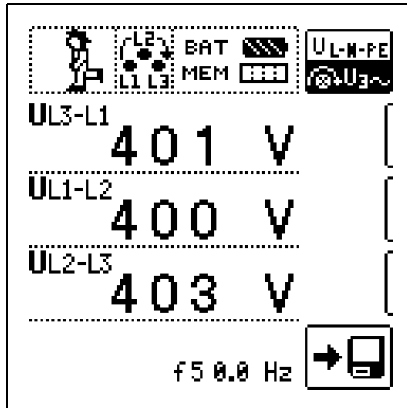

A clockwise phase sequence is required at all 3-phase electrical outlets.

- Measurement instrument connection is usually problematic with CEE outlets due to contact problems. Measurements can be executed quickly and reliably without contact problems with the help of the Z500A variable plug adapter set available from GMC.
- Connection for 3-wire measurement: L1-L2-L3 at plug in clockwise direction as of PE socket

Direction of rotation is indicated by means of the following displays:



Note

See section 16 regarding all indications for the mains connection test.

Voltage polarity

If the installation of single-pole switches to the neutral conductor is prohibited by the standards, voltage polarity must be tested in order to assure that all existing single-pole switches are installed to the phase conductors.

7 Testing RCDs

Testing of residual current devices (RCDs) includes:

- Visual inspection
- Testing
- Measurement

Use the test instrument for testing and measurement.

Measuring Method

The following must be substantiated by generating a fault current downstream from the RCD:

- That the RCD is tripped no later than upon reaching its nominal fault current value
- That continuously allowable touch voltage value U_L agreed upon for the respective system is not exceeded

This is achieved by means of:

- Touch voltage measurement, 10 measurements with full-waves and extrapolation of $I_{\Delta N}$

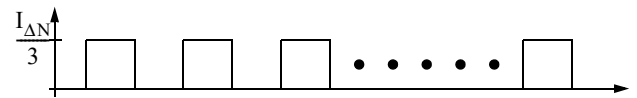

- Substantiation of tripping within 400 ms or 200 ms with $I_{\Delta N}$

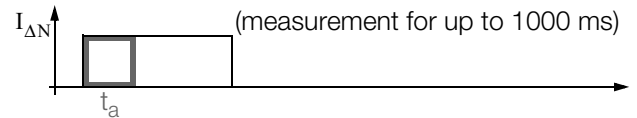

- Substantiation of tripping current with rising residual current. This value must be between 50% and 100% of $I_{\Delta N}$ (usually about 70%).

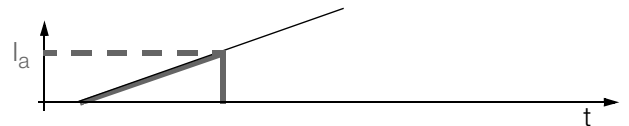

- No premature tripping with the test instrument, because testing is begun with 30% residual current (if no bias current occurs within the system)

RCD/FI Table	Differential Current Waveform	Correct RCD/RCCB Function			
		Type AC	Type A/F	Type B/B+	Type EV/MI
Alternating current	Suddenly occurring 	✓	✓	✓	✓
	Slowly rising 				
Pulsating direct current	Suddenly occurring 		✓	✓	✓
	Slowly rising 				
Direct current				✓	✓
Direct current up to 6 mA					✓

Test Standard

The following must be substantiated per DIN VDE 0100-600:2008:

- Touch voltage occurring at nominal residual current may not exceed the maximum allowable value for the system.
- Tripping of the RCCB must occur within 400 ms (1000 ms for selective RCDs) at nominal residual current.

Important Notes

- The **PROFITEST INTRO** permits simple measurements at all types of RCDs. Select RCD, SRCD, PRCD etc.
- Measurement must be executed at one point only per RCD (RCCB) within the connected electrical circuits. Low-resistance continuity must be substantiated for the protective conductor at all other connections within the electrical circuit (R_{LO} or U_B).
- The measuring instruments often display 0.1 V touch voltage in TN systems due to low protective conductor resistance.
- Be aware of any bias currents within the system. These may cause tripping of the RCDs during measurement of touch voltage U_B , or may result in erroneous displays for measurements with rising current: Display = $I_F \blacktriangleleft - I_{\text{bias_current}}$
- Selective RCDs identified with an **S** can be used as the sole means of protection for automatic shutdown if they adhere to the same shutdown conditions as non-selective RCDs (i.e. $t_a < 400$ ms). This can be substantiated by measuring breaking time.
- Type B RCDs may not be connected in series with type A or F RCDs.



Note

Bias Magnetization

Suppression of RCD tripping by means of bias magnetization with direct current is only possible via a country-specific measuring adapter, e.g. **PRO-Schuko measuring adapter (Z503K)** or the **KS-PROFITEST INTRO (Z503L)** for 3-pole measurement.

7.1 Measuring Touch Voltage (with reference to nominal residual current) with $\frac{1}{3}$ Nominal Residual Current and Tripping Test with Nominal Residual Current

Select the Measuring Function

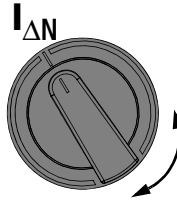

Connection

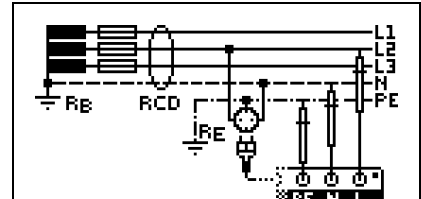

- Measurement of $I_{\Delta N}$ with $U_{I\Delta N}$ and R_E without tripping of RCD.
- $U_{I\Delta N}$ - and R_E -Measure: Press **START**
- Subsequently, trip RCD: Press **IΔN**

Setting Parameters for $I_{\Delta N}$

30mA RCD TYP A

Nom. res. current: 10 ... 500 mA **Ef**

Type 1: RCD, SRCD, PRCD etc.

Type 2: AC , A/F , B/B+ , EV/MI *

Nominal current: 6 ... 125 A

* Type B/B+/EV/MI = AC/DC sensitive

IΔN: 30mA

IΔN: 5mA

IΔN: 10mA

IΔN: 30mA

IΔN: 100mA

IΔN: 300mA

IΔN: 500mA

IΔN: 25A

1 x IΔN

Waveform:

Phase displacement: 0°/180°

Negative/positive half-wave

Positive direct current

X times tripping current

1, 2, 5 ($I_{\Delta N}$ max. 300 mA)

0°

180°

NEG:

POS:

Limits

Touch voltage: **UL: <50V**

< 25 V, < 50 V, < 65 V

Time to trip: **UL: <250ms**

UL: <50ms

UL: <65V

1) Measuring Touch Current Without Tripping the RCD

Measuring Method

The instrument uses a measuring current of only $\frac{1}{3}$ nominal residual current for the determination of touch voltage $U_{I\Delta N}$ which occurs at nominal residual current. This prevents tripping of the RCCB.

This measuring method is especially advantageous, because touch voltage can be measured quickly and easily at any electrical outlet without tripping the RCCB.

The usual, complex measuring method involving testing for the proper functioning of the RCD at a given point, and subsequent substantiation that all other systems components requiring protection are reliably connected at low resistance values to the selected measuring point via the PE conductor, is made unnecessary.

N-PE Reversal Test

Additional testing is conducted in order to determine whether or not N and PE are reversed. The pop-up window shown at the right appears in the event of reversal.

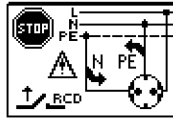

Attention!

In order to prevent the loss of data in data processing systems, perform a data backup before starting the measurement and switch off all consumers.

Start Measurement

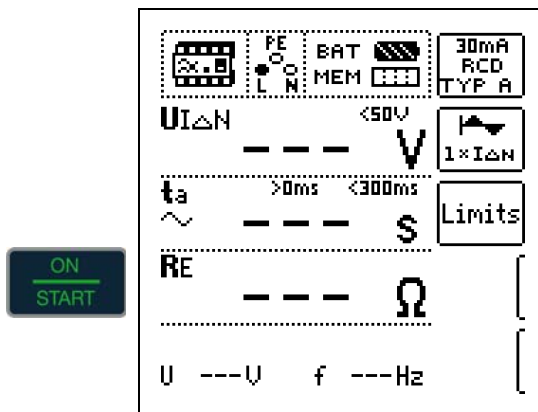

Amongst other values, touch voltage $U_{I\Delta N}$ and calculated earthing resistance R_E appear at the display panel.



Note

The measured earthing resistance value R_E is acquired with very little current. More accurate results can be obtained with the selector switch in the R_E position. The DC +  function can be selected here for systems with RCCBs.

Unintentional Tripping of the RCD due to Bias Current within the System

If bias currents should occur, they can be measured with the help of a clamp type current transformer. The RCCB may be tripped during the testing of touch voltage if extremely large bias currents are present within the system, or if a test current was selected which is too great for the RCCB.

After touch voltage has been measured, testing can be performed to determine whether or not the RCCB is tripped within the selected time limit values at nominal residual current.

Unintentional Tripping of the RCD due to Leakage Current in the Measuring Circuit

Measurement of touch voltage with 30% nominal residual current does not normally trip an RCCB. However, the trip limit may be exceeded as a result of leakage current in the measuring circuit, e.g. due to interconnected consumers with EMC circuit, e.g. frequency converters or PCs.

2) Tripping Test after the Measurement of Touch Voltage

⇒ Press the $I_{\Delta N}$ key

The tripping test need only be performed at one measuring point for each RCCB.

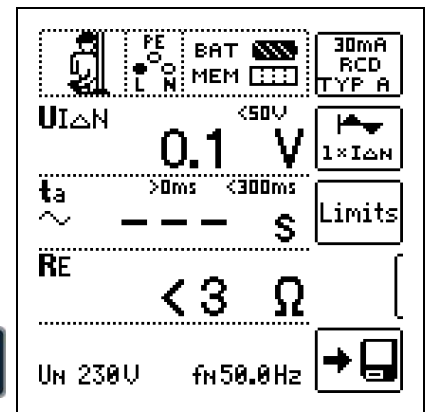

If the RCCB is not tripped at nominal residual current, the MAINS/NETZ LED blinks red (line voltage disconnected) and, amongst other values, time to trip t_a and earthing resistance R_E appear at the display panel.

If the RCCB is not tripped at nominal residual current, the LIMIT LED lights up red.

Touch Voltage Too High

If touch voltage $U_{I\Delta N}$, which has been measured with $\frac{1}{3}$ nominal residual current $I_{\Delta N}$ and extrapolated to $I_{\Delta N}$, is > 50 V (> 25 V), the LIMIT LED lights up red.

If touch voltage $U_{I\Delta N}$ exceeds 50 V (25 V) during the measuring sequence, safety shut-down occurs.



Note

Safety Shut-down: At up to 70 V, a safety shut-down is tripped within 3 seconds in accordance with IEC 61010.

Touch voltages of up to 70 V are displayed. If the value is greater than 70 V, $U_{I\Delta N} > 70$ V is displayed.

Limit Values for Allowable, Continuous Touch Voltage

The limit for allowable, continuous touch voltage is equal to $U_L = 50$ V for alternating voltages (international agreement). Lower values have been established for special applications (e.g. medical applications: $U_L = 25$ V).



Attention!

If touch voltage is too high, or if the RCCB is not tripped, the system must be repaired (e.g. earthing resistance is too high, defective RCCB etc.)!

3-Phase Connections

For proper RCD testing at three-phase connections, the tripping test must be conducted for one of the three phase conductors (L1, L2 or L3).

Inductive Power Consumers

Voltage peaks may occur within the measuring circuit if inductive consumers are shut down during an RCCB trip test. If this is the case, the test instrument might not display any measured value (---). If this message appears, switch all consumers off before performing the trip test. In extreme cases, one of the fuses in the test instrument may blow, and/or the test instrument may be damaged.

7.2 Special Tests for Systems and RCCDs

7.2.1 Testing Systems and RCCBs with Rising Residual Current (AC) for Type AC, A/F, B/B+ and EV, MI RCCDs

Measuring Method

The instrument generates a continuously rising residual current of $(0.3 \dots 1.3) \cdot I_{\Delta N}$ within the system for the testing of RCCDs. The instrument stores the touch voltage and tripping current values which were measured at the moment tripping of the RCCB occurred, and displays them.

One of the touch voltage limit values, $U_L = 25 \text{ V}$ or $U_L = 50/65 \text{ V}$, can be selected for measurement with rising residual current.

Select the Measuring Function

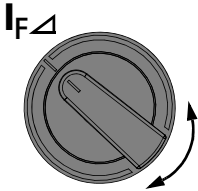

Connection

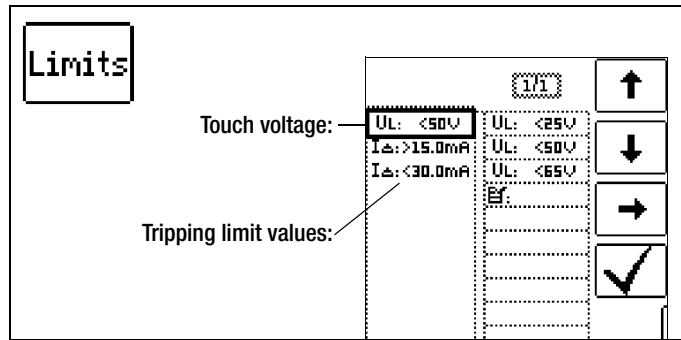
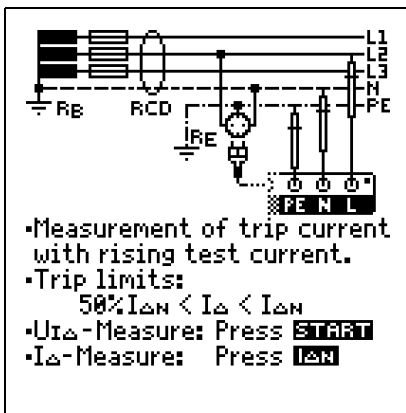

Start Measurement

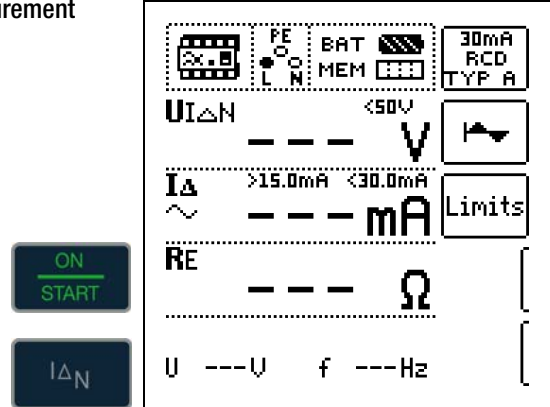

Measuring Sequence

After the measuring sequence has been started, the test current generated by the instrument is continuously increased starting at 0.3 times nominal residual current, until the RCCB is tripped. This can be observed by viewing gradual filling of the triangle at I_{Δ} .

If touch voltage reaches the selected limit value ($U_L = 65 \text{ V}$, 50 V or 25 V) before the RCCB is tripped, safety shut-down occurs. The **LIMIT LED** lights up red.



Note

Safety Shut-down: At up to 70 V, a safety shut-down is tripped within 3 seconds in accordance with IEC 61010.

If the RCCB is not tripped before the rising current reaches nominal residual current $I_{\Delta N}$, the **LIMIT LED** lights up red.



Attention!

If bias current is present within the system during measurement, it's superimposed onto the residual current which is generated by the instrument and influences measured values for touch voltage and tripping current. See also section 7.1.

Evaluation

According to DIN VDE 0100-600, rising residual current must, however, be used for measurements in the evaluation of RCCDs, and touch voltage at nominal residual current $I_{\Delta N}$ must be calculated from the measured values.

The faster, more simple measuring method should thus be taken advantage of (see section 7.1).

7.2.2 Testing Systems and RCCBs with Rising Residual Current (AC) for Type B/B+ and EV, MI RCCDs

In accordance with VDE 0413-6, it must be substantiated that, with smooth direct current, residual operating current is no more than twice the value of rated residual current $I_{\Delta N}$. A continuously rising direct current, beginning with 0.2 times rated residual current $I_{\Delta N}$, must be applied to this end. If current rise is linear, rising current may not exceed twice the value of $I_{\Delta N}$ within a period of 5 seconds.

Testing with smoothed direct current must be possible in both test current directions.

Setting Parameters for $I_{\Delta N}$

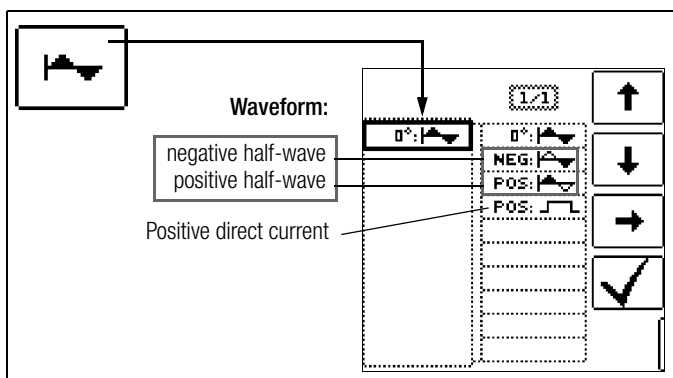
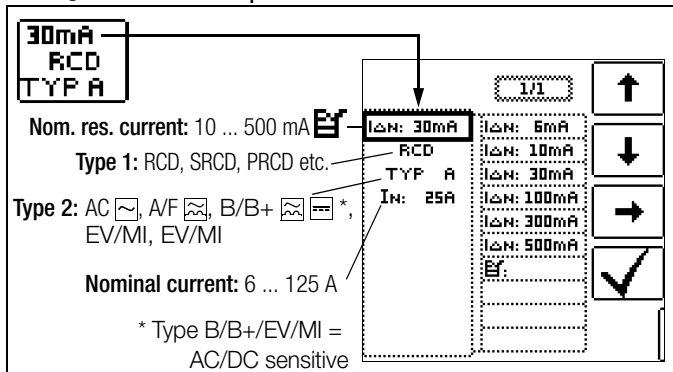

7.2.3 Testing RCCBs with $5 \cdot I_{\Delta N}$

Measurement of time to trip is performed here with 5 times nominal residual current.

Note

Measurements performed with 5 times nominal fault current are required for testing type **S** and **G** RCCBs in the manufacturing process. They are used for personal safety as well.

Measurement can be started with the positive half-wave at "0°" or with the negative half-wave at "180°".

Both measurements must nevertheless be performed. The longer of the two tripping times is decisive regarding the condition of the tested RCCB. Both values must be less than 40 ms.

Select the Measuring Function

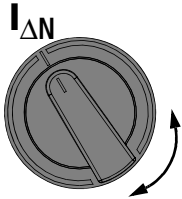

Set the Parameter – Start with Positive or Negative Half-Wave

Waveform: 0°: $1 \times I_{\Delta N}$, 180°: $1 \times I_{\Delta N}$

180°: Start with negative half-wave
0°: Start with positive half-wave

Positive direct current

Set the Parameter – 5 Times Nominal Current

X times tripping current: $1 \times I_{\Delta N}$, $2 \times I_{\Delta N}$, $5 \times I_{\Delta N}$

5 times tripping current

Note

The following restrictions apply to the selection of tripping current multiples relative to nominal current:
500 mA: $1 \times$, $2 \times I_{\Delta N}$

Start Measurement

30mA RCD TYP A

UI Δ N <50V V

t_a >0ms <40ms S Limits

RE Ω

U ---V f ---Hz

ON START

I Δ N

7.2.4 Testing of RCCBs Pulsating DC Residual Current

In this case, RCCBs can be tested with either positive or negative half-waves. The standard calls for tripping at 1.4 times nominal current.

Select the Measuring Function

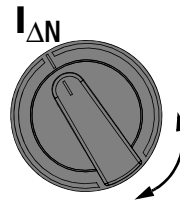

Set the Parameter – Positive or Negative Half-Wave

Waveform: 0°: $1 \times I_{\Delta N}$, 180°: $1 \times I_{\Delta N}$

Negative half-wave
Positive half-wave

Positive direct current

Set the Parameter – Test With and Without "No-Trip Test"

50% I Δ N*
X times tripping current: $1 \times I_{\Delta N}$, $2 \times I_{\Delta N}$, $5 \times I_{\Delta N}$

* No-trip test with 50% I Δ N

No-Trip Test

If, during the no-trip test which lasts for 1 second, the RCD trips too early at 50% I Δ N, i.e. before the actual tripping test starts, the pop-up window shown at the right appears.

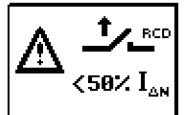

Note

The following restriction applies to the selection of tripping current multiples relative to nominal current: double and five-fold nominal current is not possible in this case.

Note

According to DIN EN 50178 (VDE 160), only type B RCCBs (AC-DC sensitive) can be used for equipment with > 4 kVA, which is capable of generating smooth DC residual current (e.g. frequency converters). Tests with pulsating DC fault current only are not suitable for these RCCBs. Testing must also be conducted with smooth DC residual current in this case.

Note

Measurement is performed with positive and negative half-waves for testing RCCBs during manufacturing. If a circuit is charged with pulsating direct current, the function of the RCCB can be executed with this test in order to assure that the RCCB is not saturated by the pulsating direct current so that it no longer trips.

7.3 Testing of Special RCDs

7.3.1 Systems with Type RCD-S Selective RCCBs

Selective RCCBs are used in systems which include two series connected RCCBs that are not tripped simultaneously in the event of a fault. These selective RCCBs demonstrate delayed response characteristics and are identified with the  symbol.

Measuring Method

The same measuring method is used as for standard RCCBs (see sections 7.1 on page 18 and 7.2.1 on page 20).

If selective RCCBs are used, earthing resistance may not exceed half of the value for standard RCCBs.

For this reason, the instrument displays twice the measured value for touch voltage.

Select the Measuring Function

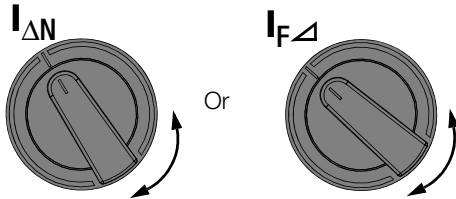

Set Parameter – Selective

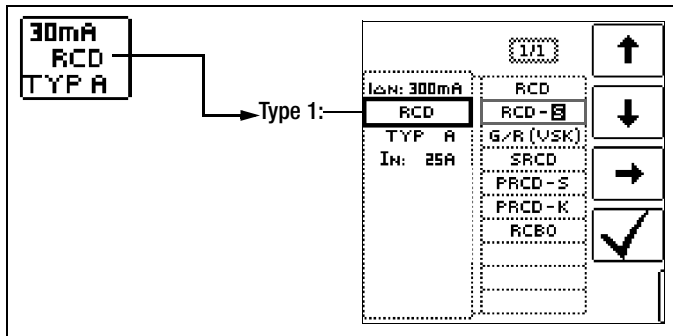

Start Measurement

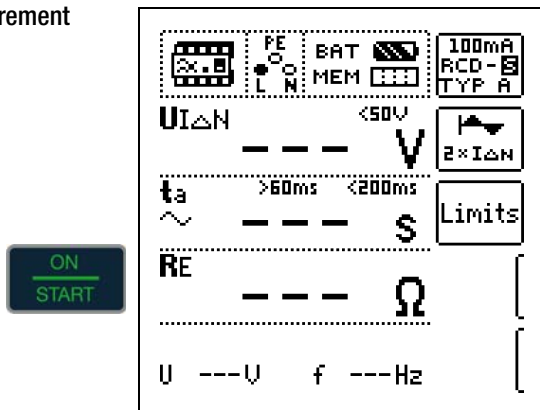

Tripping Test

- Press the $I_{\Delta N}$ key. The RCCB is tripped. Blinking bars appear at the display panel, after which time to trip t_A and earthing resistance R_E are displayed.

The tripping test need only be performed at one measuring point for each RCCB.

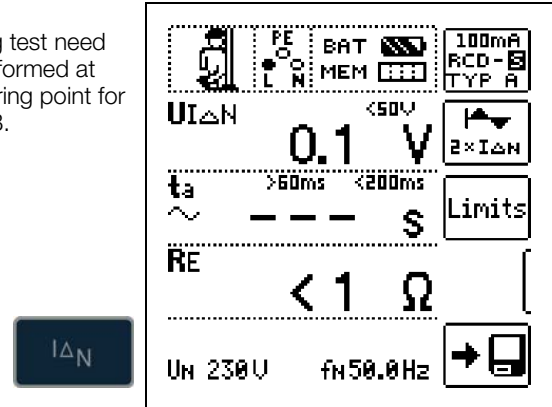

Note

Selective RCCBs demonstrate delayed response characteristics. Tripping performance is briefly influenced (up to 30 s) due to pre-loading during measurement of touch voltage. In order to eliminate pre-charging caused by the measurement of touch voltage, a waiting period must be observed prior to the tripping test. After the measuring sequence has been started (tripping test), blinking bars are displayed for approximately 30 seconds. Tripping times of up to 1000 ms are allowable. The tripping test is executed immediately after once again pressing the $I_{\Delta N}$ key.

7.3.2 PRCDs with Non-Linear Type PRCD-K Elements

The PRCD-K is a portable RCD with electronic residual current evaluation laid out as an inline device which switches all poles (L, N and PE). Undervoltage tripping and protective conductor monitoring are additionally integrated into the PRCD-K.

The PRCD-K is equipped with undervoltage tripping, for which reason it has to be operated with line voltage, and measurements may only be performed in the on state (the PRCD-K switches all poles).

Terminology (from DIN VDE 0661)

Portable protective devices are circuit breakers which can be connected between power consuming devices and permanently installed electrical outlets by means of standardized plug-and-socket devices.

A reusable, portable protective device is a protective device which is designed such that it can be connected to movable cables.

Please be aware that a non-linear element is usually integrated into PRCDs, which leads to immediate exceeding of the greatest allowable touch voltage during $U_{I\Delta}$ measurements ($U_{I\Delta}$ greater than 50 V).

PRCDs which do not include a non-linear element in the protective conductor must be tested in accordance with section 7.3.3 on page 23.

Objective (from DIN VDE 0661)

Portable residual current devices (PRCDs) serve to protect persons and property. They allow for the attainment of increased levels of protection as provided by protective measures utilized in electrical systems for the prevention of electrical shock as defined in DIN VDE 0100-410. They are to be designed such that they can be installed by means of a plug attached directly to the protective device, or by means of a plug with a short cable.

Measuring Method

The following can be measured, depending upon the measuring method:

- Time to trip t_A : tripping test with nominal residual current $I_{\Delta N}$ (the PRCD-K must be tripped at 50% nominal current).
- Tripping current I_{Δ} for testing with rising residual current $I_{F\Delta}$

Select the Measuring Function

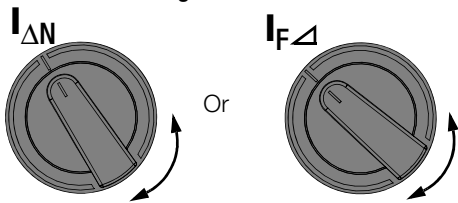

Connection

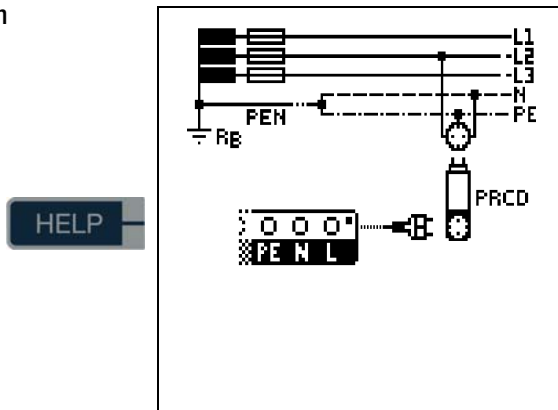

Set the Parameter – PRCD with Non-Linear Elements

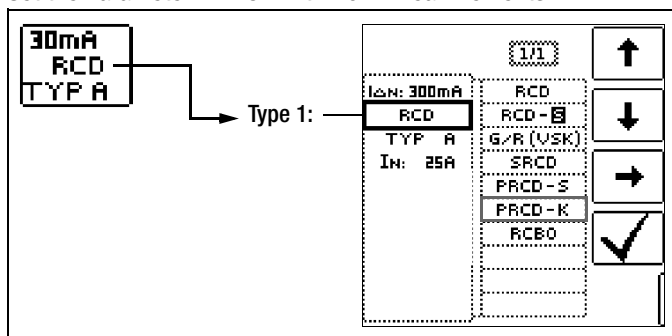

Start Measurement

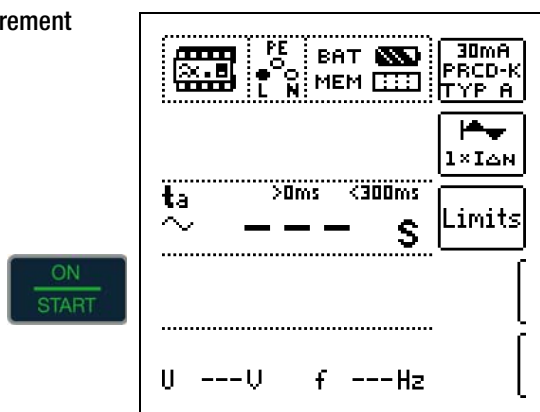

7.3.3 SRCD, PRCD-S (SCHUKOMAT, SIDOS or comparable)

RCCBs from the SCHUKOMAT SIDOS series, as well as others which are of identical electrical design, must be tested after selecting the corresponding parameter.

Monitoring of the PE conductor is performed for RCDs of this type. The PE conductor is monitored by the summation current transformer. If residual current flows from L to PE, tripping current is cut in half, i.e. the RCCB must be tripped at 50% nominal residual current $I_{\Delta N}$.

Whether or not PRCDs and selective RCDs are of like design can be tested by means of the touch voltage $U_{I\Delta N}$ measurement. If a touch voltage $U_{I\Delta N}$ of greater than 70 V is measured at the PRCD of an otherwise error-free system, the PRCD more than likely contains a non-linear element.

PRCD-S

The PRCD-S (portable residual current device – safety) is a special, portable protective device with protective conductor detection or protective conductor monitoring. The device serves to protect persons from electrical accidents in the low-voltage range (130 to 1000 V). The PRCD-S must be suitable for commercial use, and is installed like an extension cable between an electrical consumer – as a rule an electric tool – and the electric outlet.

Select the Measuring Function

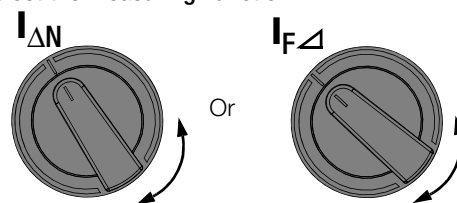

Set Parameter – SRCD / PRCD

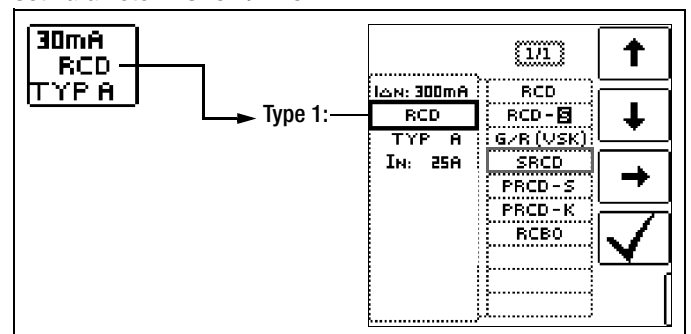

Start Measurement

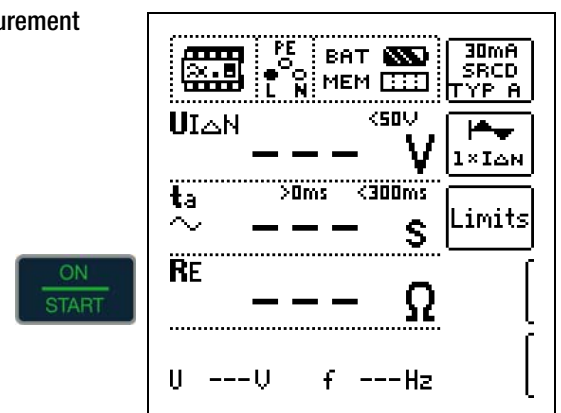

7.3.4 Type G or R RCCB

In addition to standard RCCBs and selective RCDs, the special characteristics of the type G RCCB can also be tested with the test instrument.

The type G RCCB is an Austrian specialty and complies with the ÖVE/ÖNORM E 8601 device standard. Erroneous tripping is minimized thanks to its greater current carrying capacity and short-term delay.

Select the Measuring Function

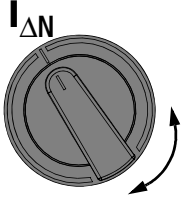

Set Parameter – Type G/R (VSK)

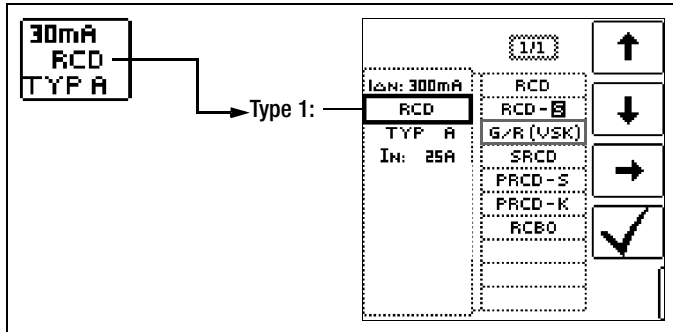

Touch voltage and time to trip can be measured in the G/R-RCD switch position.



Note

It must be observed that time to trip for type G RCCBs may be as long as 1000 ms when measurement is made at nominal residual current. Set the limit value correspondingly.

- Then select $5 \times I_{\Delta N}$ in the menu (this is selected automatically for the G/R setting) and repeat the tripping test beginning with the positive half-wave at 0° and the negative half-wave at 180° . The longer of the two tripping times is decisive regarding the condition of the tested RCCB.

Set the Parameter – Start with Positive or Negative Half-Wave

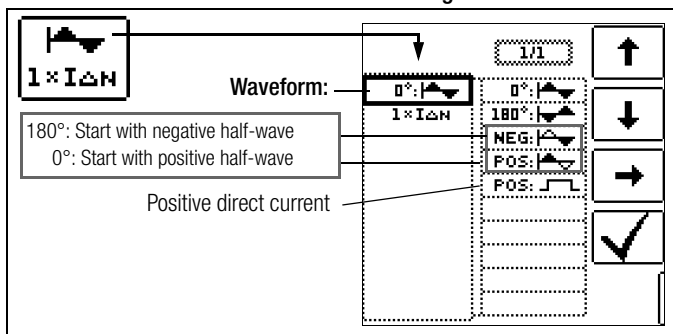

Set the Parameter – 5 Times Nominal Current

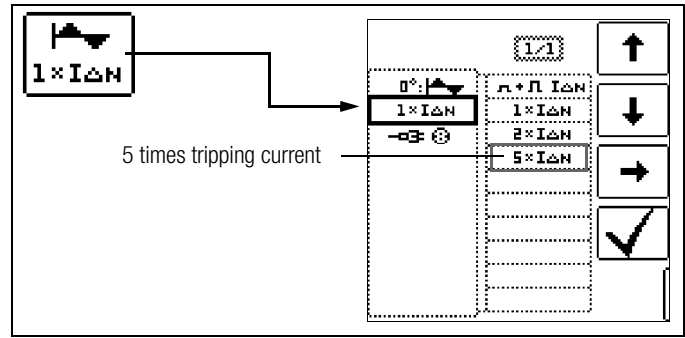

Note

The following restrictions apply to the selection of tripping current multiples relative to nominal current:
500 mA: 1 x, 2 x $I_{\Delta N}$

Start Measurement

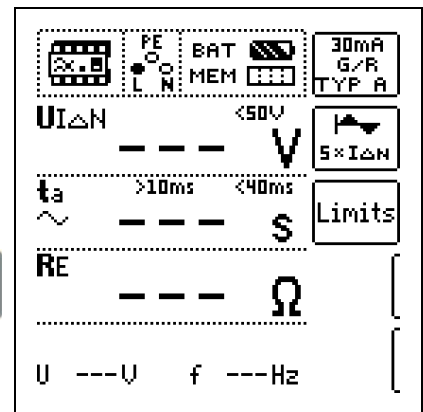
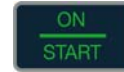

In both cases tripping time must be between 10 ms (minimum delay time for type G RCCBs) and 40 ms.

Type G RCCBs with other nominal residual current values must be tested with the corresponding parameter setting under menu item $I_{\Delta N}$. In this case as well, the limit value must be appropriately adjusted.



Note

The RCD S parameter setting for selective RCCBs is not suitable for type G RCCBs.

7.4 Testing Residual Current Circuit Breakers in TN-S Systems

Connection

RCCBs can only be used in TN-S systems. An RCCB would not work in a TN-C system because PE is directly connected to the neutral conductor in the outlet (it does not bypass the RCCB). This means that residual current would be returned via the RCCB and would not generate any differential current, which is required in order to trip the RCCB.

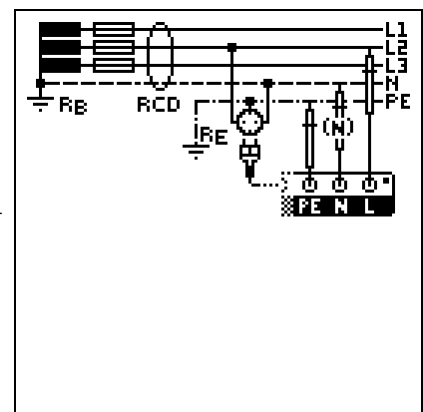

As a rule, the display for touch voltage is also 0.1 V, because the nominal residual current of 30 mA together with minimal loop resistance result in a very small voltage value:

$$U_{I\Delta N} = R_E \cdot I_{\Delta N} = 1 \Omega \cdot 30 \text{ mA} = 30 \text{ mV} = 0,03 \text{ V}$$

8 Testing of Breaking Requirements for Overcurrent Protective Devices, Measurement of Loop Impedance and Determination of Short-Circuit Current (functions Z_{L-PE} and I_K)

Testing of overcurrent protective devices includes visual inspection and measurement. Use the **PROFITEST INTRO** to perform measurements.

Measuring Method

Loop impedance Z_{L-PE} is measured and short-circuit current I_K is ascertained in order to determine if the breaking requirements for protective devices have been fulfilled.

Loop impedance is the resistance within the current loop (utility station – phase conductor – protective conductor) when a short-circuit to an exposed conductive part occurs (conductive connection between phase conductor and protective conductor). Short-circuit current magnitude is determined by the loop impedance value. Short-circuit current I_K may not fall below a predetermined value set forth by DIN VDE 0100, so that reliable breaking of the protective device (fuse, automatic circuit breaker) is assured.

Thus the measured loop impedance value must be less than the maximum allowable value.

Tables containing allowable display values for loop impedance and minimum short-circuit current display values for ampere ratings for various fuses and circuit breakers can be found in the help texts and in section 19 beginning on page 54. Maximum device error in accordance with VDE 0413 has been taken into consideration in these tables. See also section 8.2.

In order to measure loop impedance Z_{L-PE} , the instrument uses a test current of 3.7 A to 7 A (60 to 550 V) depending on line voltage and line frequency. The test has a duration of max. 1200 ms at 16 Hz.

If dangerous touch voltage occurs during measurement (> 50 V), safety shut-down occurs.

The test instrument calculates short-circuit current I_K based on measured loop impedance Z_{L-PE} and line voltage. Short-circuit current calculation is made with reference to nominal line voltage for line voltages which lie within the nominal ranges for 120 V, 230 V and 400 V systems. If line voltage does not lie within these nominal ranges, the instrument calculates short-circuit current I_K based upon prevailing line voltage and measured loop impedance Z_{L-PE} .

Measuring Method with Suppression of RCD Tripping

The **PROFITEST INTRO** provides users with the opportunity of measuring loop impedance within systems which are equipped with RCCBs.

The test instrument generates a direct current to this end, which saturates the RCCB's magnetic circuit.

The test instrument then superimposes a measuring current which only demonstrates half-waves of like polarity. The RCCB is no longer capable of detecting this measuring current, and is consequently not tripped during measurement.

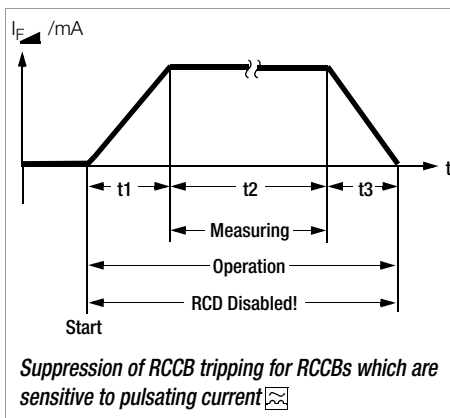

Select the Measuring Function

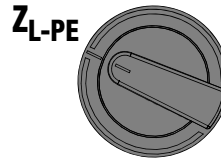

Connection:

Schuko/3-pole

(country specific)

HELP

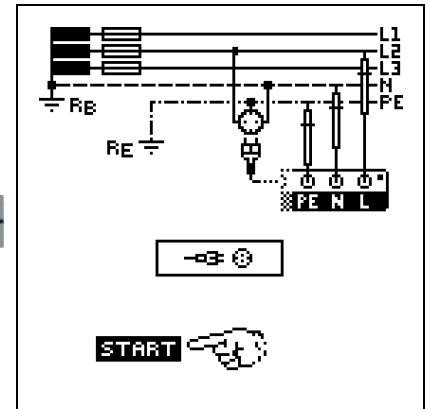

Connection: 2-pole

HELP

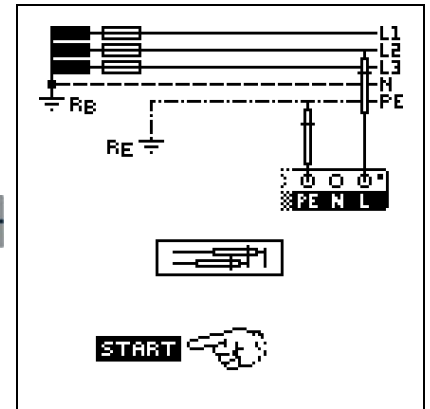

Note

Loop impedance should be measured for each electrical circuit at the farthest point, in order to ascertain maximum loop impedance for the system.

Note

Bias Magnetization

Suppression of RCD tripping by means of bias magnetization with direct current is only possible via a country-specific measuring adapter, e.g. PRO-Schuko measuring adapter (Z503K) or the KS-PROFITEST INTRO (Z503L) for 3-pole measurement (neutral conductor required).

Note

Observe national regulations, e.g. the necessity of conducting measurements without regard for RCCBs in Austria.

3-Phase Connections

Measurement of loop impedance to earth must be performed at all three phase conductors (L1, L2, and L3) for the testing of overcurrent protective devices at three phase outlets.

8.1 Measurements with Suppression of RCD Tripping

8.1.1 Measurement with Positive Half-Waves

Measurement by means of half-waves plus direct current makes it possible to measure loop impedance in systems which are equipped with RCCBs. In the case of DC measurement with half-waves, selection can be made from two variants:

- DC-L: Minimal bias current allowing for faster measurement
- DC-H: Higher bias current providing more reliability with regard to non-tripping of the RCD

Select the Measuring Function

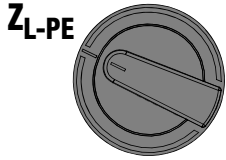

Set Parameters

IN 16A
 TYP: B/L
 1.5 mm²

IN: 16A
 5 x IN(B/L)
 Ø: 1.5 mm²
 NYM-J
 3 - ADRIG

1/PE
 ↑
 ↓
 →
 ✓

Nom. current: 2 ... 160 A, $I_{n,9999}$ A

Tripping characteristics:
 A, B/L, C/G, D, E, H, K, GL/GG & factor

Diameter*: 1.5 to 70 sq. mm

Cable types*: NY... - H07...

Number of wires*: 1 to 10-strand

In: 2.0A
In: 3.0A
In: 4.0A
In: 5.0A
In: 6.0A
In: 8.0A
In: 10A
In: 13A
In: 16A
In: 20A
In: 25A

* Parameters which are only used for report generation and do not influence the measurement

UL <50V
 DC

UL: <50V
 DC-H+

1/1
 ↑
 ↓
 →
 ✓

Touch voltage:
 Waveform:
 Sinusoidal
 15 mA sinusoidal
 DC-L and positive half-wave
 DC-H and positive half-wave

- Sinusoidal (full-wave)** Setting for circuit without RCD
- 15 mA sinusoidal** Setting for motor protection switch only with small nominal current
- DC + half-wave** Setting for circuit with RCD

Meas. with country-specific measuring adapter (e.g. Schuko)

L1-PE

2-pole measurement

1/1
 ↑
 ↓
 →
 ✓

Note
 Selecting the test probe, as well as Lx-PE reference or AUTO, is only relevant with regard to report generation.

L1-PE

Polarity selection

1/1
 ↑
 ↓
 →
 ✓

Semiautomatic measurement
 See also section 5.8 regarding the AUTO parameter.

Measurement Cable Compensation

The resistance of the respectively connected measurement cable or the country-specific measuring adapter must be compensated for each loop impedance measurement, i.e. it must be subtracted from the measurement results as an offset. Proceed as described in section 4.5 under „OFFSET RL-PE / RN-PE / RL-N“ on page 12 to this end, in order to ascertain offset values **RLPE-OFFSET** and **RNPE-OFFSET**.

Start Measurement

PE
 L N

BAT MEM

IN 16A
 TYP: B/L
 1.5mm²

ZL-PE --- Ω **UL <50V**

IK >120A --- A **Limits IK: 2/3Z**

L1-PE → ⊕ ⊙

RNPE-OFFSET 0.45 Ω
 U ---U f ---Hz

PE
 L N

BAT MEM

IN 16A
 TYP: B/L
 1.5mm²

ZL-PE --- Ω **UL <50V**

IK >120A --- A **Limits IK: 2/3Z**

L1-PE → ⊕ ⊙ **01/03** **AUTO**

RLPE-OFFSET 0.38 Ω
 U ---U f ---Hz

Semiautomatic Measurement

8.2 Evaluation of Measured Values

The maximum allowable loop impedance Z_{L-PE} which may be displayed after allowance has been made for maximum operating measurement error (under normal measuring conditions) can be determined with the help of Table 1 on page 54. Intermediate values can be interpolated.

The maximum allowable nominal current for the protective device (fuse or circuit breaker) for a line voltage of 230 V after allowance has been made for maximum measuring error can be determined with the help of Table 5 on page 55 based upon measured short-circuit current (corresponds to DIN VDE 0100-600).

PE
 L N

BAT MEM

IN 16A
 TYP: B/L
 1.5mm²

ZL-PE **943 mΩ** **UL <50V**

IK >120A **244 A** **Limits IK: 2/3Z**

L1-PE → ⊕ ⊙ **01/03** **AUTO**

RLPE-OFFSET 0.38 Ω
 U_n 230V f_n 50.0Hz

Special Case: Suppressing Display of the Limit Value

The limit value cannot be ascertained. The inspector is prompted to evaluate the measured values and to acknowledge or reject them with the help of the softkeys.

Measurement passed: ✓ key

Measurement failed: X key

The measured value can only be saved after it has been evaluated.

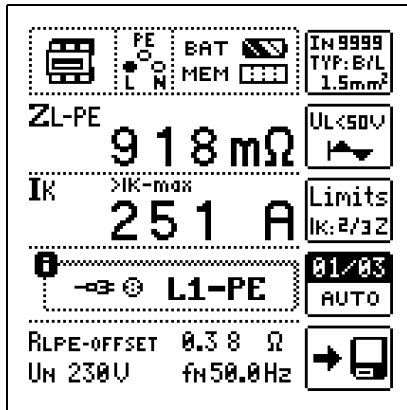
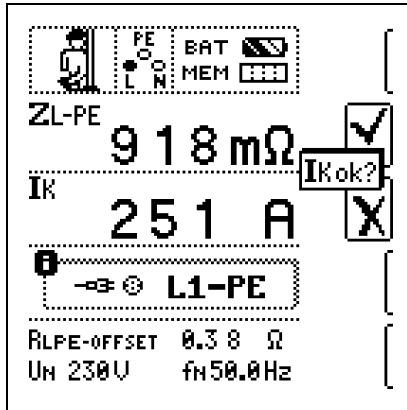

8.3 Settings for Calculating Short-Circuit Current – Parameter I_K

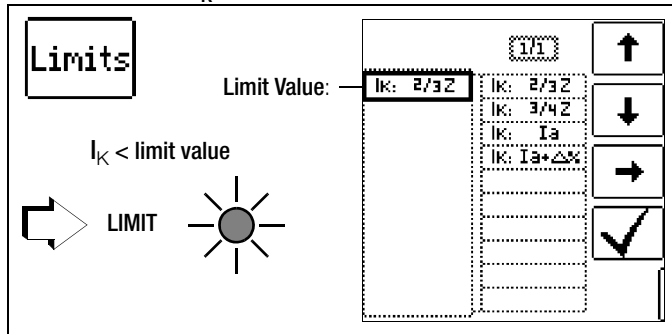

Short-circuit current I_K is used to test shutdown by means of an overcurrent protective device. In order for an overcurrent protective device to be tripped on time, short-circuit current I_K must be greater than tripping current I_a (see table 6 in section 19.1). The variants which can be selected with the “Limits” key have the following meanings:

- $I_K: I_a$ The measured value displayed for I_K is used without any correction to calculate Z_{L-PE} .
 - $I_K: I_a + \Delta\%$ The measured value displayed for Z_{L-PE} is corrected by an amount equal to the test instrument’s measuring uncertainty in order to calculate I_K .
 - $I_K: 2/3 Z$ In order to calculate I_K , the measured value displayed for Z_{L-PE} is corrected by an amount corresponding to all possible deviations (these are defined in detail by VDE 0100-60 as $Z_{s(m)} \leq 2/3 \times U_0 / I_a$).
 - $I_K: 3/4 Z$ $Z_{s(m)} \leq 3/4 \times U_0 / I_a$
- I_K Short-circuit current calculated by the instrument (at nominal voltage)
 Z Fault loop impedance
 I_a Tripping current (see data sheet for circuit breakers / fuses)
 $\Delta\%$ Test instrument inherent error

Special case: $I_K > I_{Kmax}$, see page 28.

See page 28 on accessing the fuse table via the **HELP** key.

9 Measuring Line Impedance (Z_{L-N} function)

Measuring Method (internal line resistance measurement)

Line impedance Z_{L-N} is measured by means of the same method used for loop impedance Z_{L-PE} (see section 8 on page 25). However, the current loop is completed via neutral conductor N rather than protective conductor PE as is the case with loop impedance measurement.

Select the Measuring Function

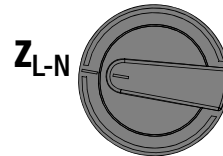

Schuko Connection (country specific)

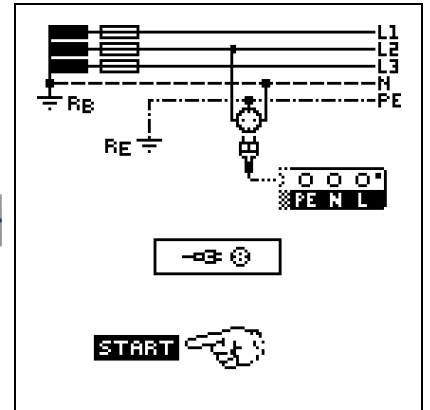

Connection: 2-pole

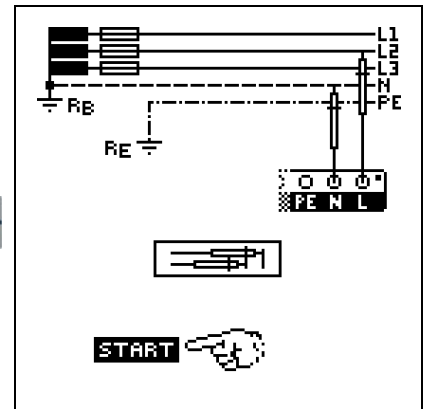

Set Parameters

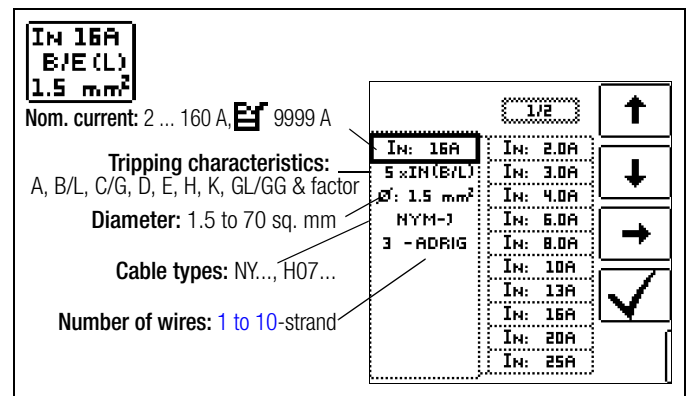

Press the softkey shown at the left in order to switch back and forth between the country-specific measuring adapter, e.g. PRO-Schuko measuring adapter (Z503K) / 3-pole measurement and the KS-PROFIT-EST INTRO (Z503L) for 2-pole measurement. The selected connection type is displayed inversely (white on black).

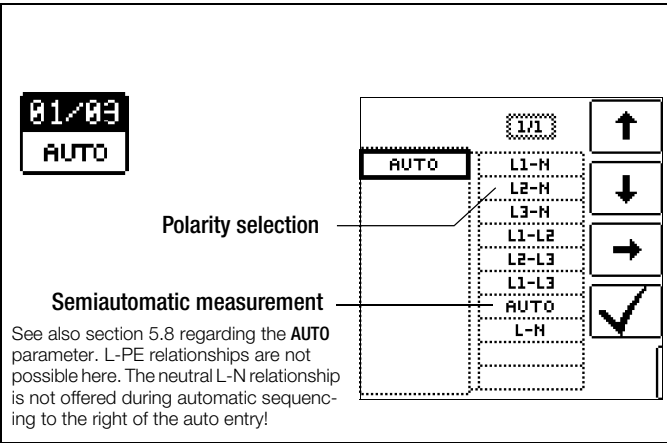

Settings for Calculating Short-Circuit Current – Parameter I_K

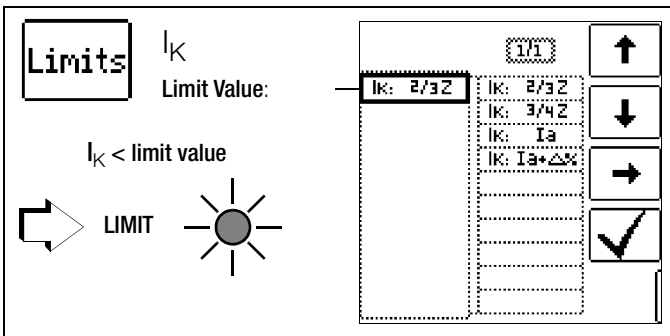

Short-circuit current I_K is used to test shutdown by means of an overcurrent protective device. In order for an overcurrent protective device to be tripped on time, short-circuit current I_K must be greater than tripping current I_a (see table 6 in section 19.1). The variants which can be selected with the "Limits" key have the following meanings:

- I_K : I_a The measured value displayed for I_K is used without any correction to calculate Z_{L-PE} .
- I_K : $I_a + \Delta\%$ The measured value displayed for Z_{L-PE} is corrected by an amount equal to the test instrument's measuring uncertainty in order to calculate I_K .
- I_K : $2/3 Z$ In order to calculate I_K , the measured value displayed for Z_{L-PE} is corrected by an amount corresponding to all possible deviations (these are defined in detail by VDE 0100-60 as $Z_{s(m)} \leq 2/3 \times U_0/I_a$).
- I_K : $3/4 Z$ $Z_{s(m)} \leq 3/4 \times U_0/I_a$
- I_K Short-circuit current calculated by the instrument (at nominal voltage)
- Z Fault loop impedance
- I_a Tripping current (see data sheet for circuit breakers / fuses)
- $\Delta\%$ Test instrument inherent error

Special case $I_K > I_{Kmax}$

If the short-circuit current value does not lie within the measured values defined in the PROFITEST INTRO, this is indicated by displaying "> I_K -max".

In this case, manual evaluation of the measurement results is required.

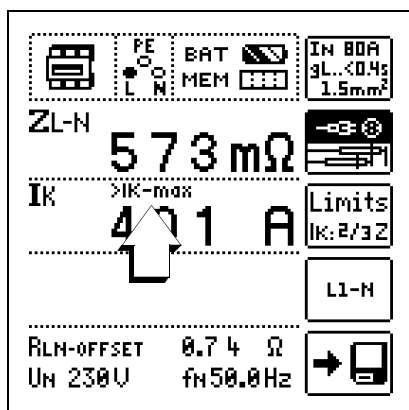

Measurement Cable Compensation

The resistance of the respectively connected measurement cable or the country-specific measuring adapter must be compensated for each line impedance measurement, i.e. it must be subtracted from the measurement results as an offset. Proceed as described in section 4.5 under „OFFSET RL-PE / RN-PE / RL-N“ on page 12 to this end in order to ascertain offset values $RLPE-OFFSET$ and $RNPE-OFFSET$

Start Measurement

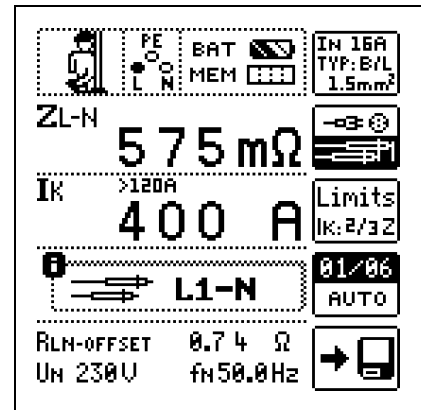
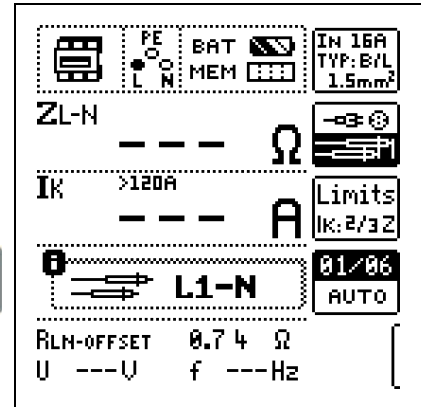

Display of U_{L-N} (U_N / f_N)

If the measured voltage value lies within a range of $\pm 10\%$ of the respective nominal line voltage of 120 V, 230 V or 400 V, the respectively corresponding nominal line voltage is displayed. In the case of measured values outside of the $\pm 10\%$ tolerance, the actual measured value is displayed.

Displaying the Fuse Table

After measurement has been performed, allowable fuse types can be displayed by pressing the HELP key.

The table shows maximum allowable nominal current dependent upon fuse type and breaking requirements.

$I_K: 400 A$	
IK: 2/3Z	
	gL/gG
In	In
A : 80A	<5s : 50A
B/L : 50A	<0.4s : 32A
E : 40A	<0.2s : 25A
C/G : 25A	<1s : 40A
D : 13A	
K : 16A	
H : 100A	

Key: I_a = breaking current, I_K = short-circuit current, I_N = nominal current, t_A = tripping time

10 Earthing Resistance Measurement (R_E function)

Earthing resistance R_E is important for automatic shutdown in system segments. It must have a low value in order to assure that high short-circuit current flows and the system is shut down reliably by the RCCB in the event of a fault.

Test Setup

Earthing resistance (R_E) is the sum of the earth electrode's dissipation resistance and earth conductor resistance. Earthing resistance is measured by applying an alternating current via the earth conductor, the earth electrode and earth electrode resistance.

Measurement without Probe (mains powered earthing measurement)

In many cases, especially in extremely built-up areas, it's difficult, or even impossible, to set a measuring probe. In such cases, earthing resistance can be measured without a probe. In this case, however, the resistance values for the operational earth electrode R_B and phase conductor L are also included in the measurement results.

Measuring Method with Suppression of RCD Tripping (mains powered earthing measurement)

The test instrument generates a direct current to this end, which saturates the RCCB's magnetic circuit.

The test instrument then superimposes a measuring current which only demonstrates half-waves of like polarity. The RCCB is no longer capable of detecting this measuring current, and is consequently not tripped during measurement.

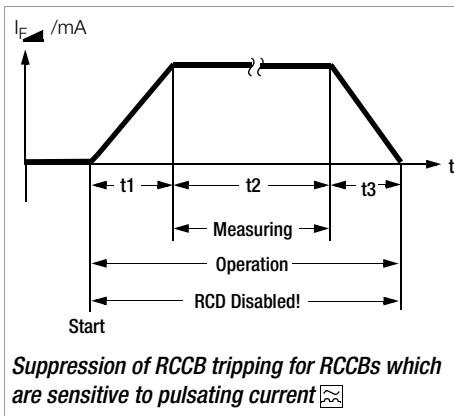

Limit values

Earthing resistance (earth coupling resistance) is determined primarily by the electrode's contact surface and the conductivity of the surrounding earth.

The specified limit value depends on the type of electrical system and its shutdown conditions in consideration of maximum touch voltage.

Evaluation of Measured Values

The maximum allowable displayed resistance values which assure that the required earthing resistance is not exceeded, and for which maximum device operating error has already been taken into consideration (at nominal conditions of use), can be determined with the help of Table 2 on page 54. Intermediate values can be interpolated.

10.1 Earth Resistance, Mains Operation – 2-Pole Measurement with KS-PROFITEST INTRO or Country-Specific Measuring Adapter (Schuko)

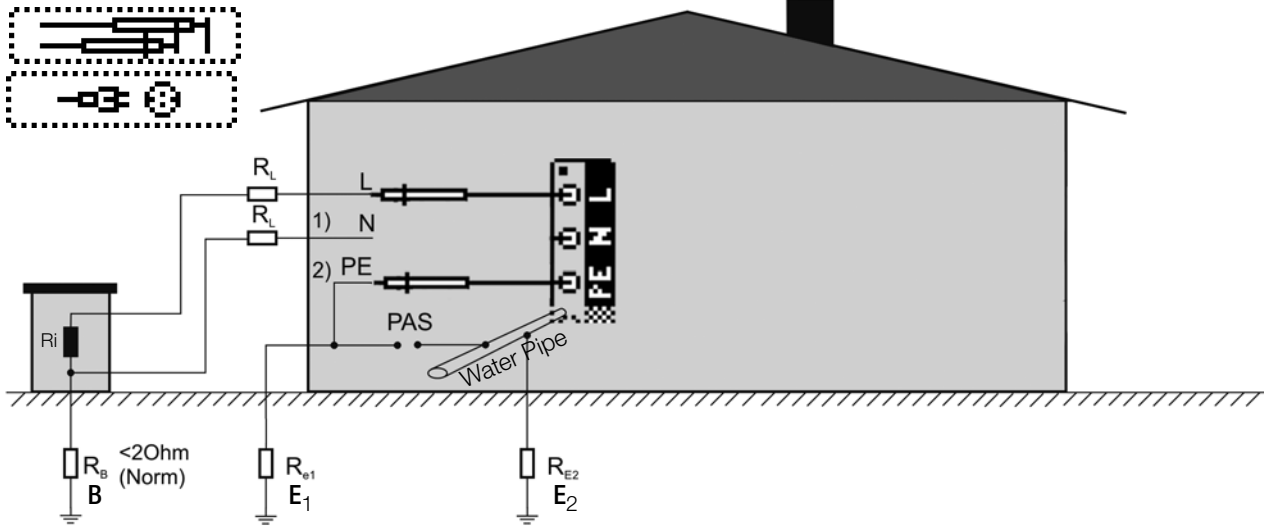

Key

R_B	Operational earth
R_E	Earth resistance
R_i	Internal resistance
R_X	Earthing resistance through equipotential bonding systems
R_S	Probe resistance
PAS	Equipotential bonding busbar
$R_{E_{\downarrow}}$	Overall earthing resistance ($R_{E1} // R_{E2} // \text{water pipe}$)

Earthing resistance can be estimated without a probe using the "earth loop resistance measurement".

The resistance value $R_{E_{Loop}}$ obtained with this measuring method also includes operational earth electrode resistance R_B and resistance at phase conductor L. These values must be deducted from the measured value in order to determine earthing resistance.

If conductors of equal cross section are assumed (phase conductor L and neutral conductor N), phase conductor resistance is half as great as supply impedance Z_{L-N} (phase conductor + neutral conductor).

Supply impedance can be measured as described in section 9 beginning on page 27. In accordance with DIN VDE 0100, the operational earth electrode R_B must lie within a range of "0 Ω to 2 Ω ".

1) Measurement: Z_{L-N} amounts to $R_i = 2 \cdot R_L$

2) Measurement: Z_{L-PE} amounts to $R_{E_{Loop}}$



3) Calculation: R_{E1} amounts to $Z_{L-PE} - 1/2 \cdot Z_{L-N}$; where $R_B = 0$

The value for operational earth conductor resistance R_B should be ignored in the calculation of earthing resistance, because it is generally unknown.

Calculated earthing resistance thus includes operational earth conductor resistance as a safety factor.

If the  parameter is selected, steps 1 through 3 are executed automatically by the test instrument.

Set Parameters

- Measuring range:** AUTO, 10 k Ω (4 mA), 1 k Ω (40 mA), 100 Ω (0.4 A), 10 Ω (> 0.8 A). In systems with RCCBs, resistance or test current must be selected such that it is less than tripping current ($1/2 I_{\Delta N}$).
 - Connection type:** 2-pole or Schuko (country-specific)
 -  2-pole measurement via the KS-PROFITEST INTRO (Z503L), measuring range max. 10 k Ω or 2-pole measurement via the PRO-Schuko measuring adapter (Z503K), measuring range max. 10 k Ω
 -  2-pole measurement via the PRO-Schuko measuring adapter (Z503K), measuring range limited to 10 Ω , as exact measurement is conducted by means of a formula
 - Touch voltage:** UL < 25 V, < 50 V, < 65 V, < xx V
 - Test current waveform:** sinusoidal (full-wave), 15 mA sinusoidal (full-wave), DC offset (DC-L or DC-H) and positive half-wave
- DC-L:** Minimal bias current allowing for faster measurement
DC-H: Higher bias current providing more reliability with regard to non-tripping of the RCD

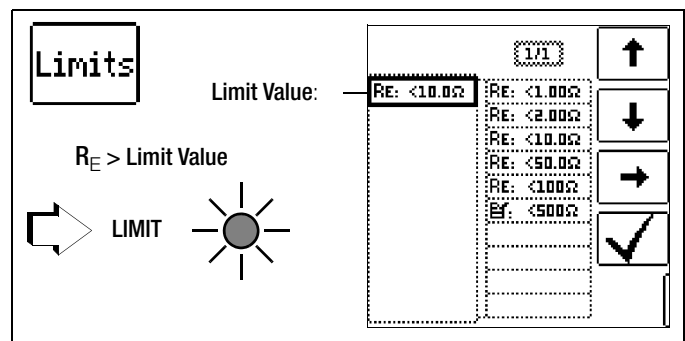

Select the Measuring Function

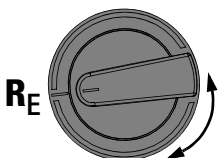

Measurement Cable Compensation

The resistance of the respectively connected measurement cable or the country-specific measuring adapter must be compensated for each earth resistance measurement, i.e. it must be subtracted from the measurement results as an offset. Proceed as described in section 4.5 under „OFFSET RL-PE / RN-PE / RL-N“ on page 12 to this end in order to ascertain offset values **RLPE-OFFSET** and **RNPE-OFFSET**.

Start Measurement

2-pole

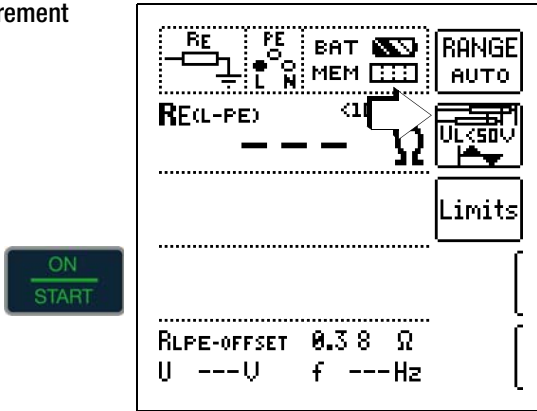

Start Measurement

Schuko
(country specific)

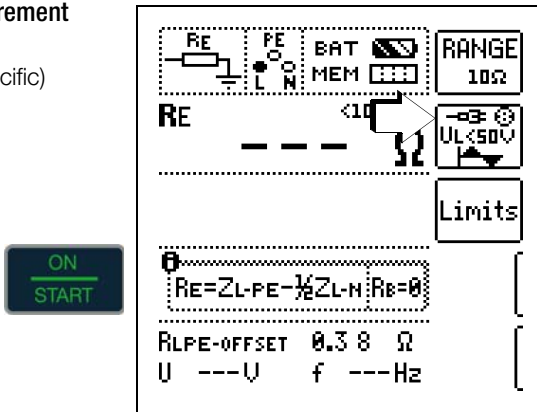

11 Measurement of Insulation Resistance



Attention!

Insulation resistance can only be measured at voltage-free objects.

11.1 General

Select the Measuring Function

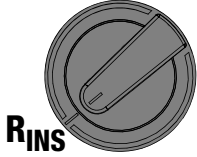

Connection

2-pole or test plug

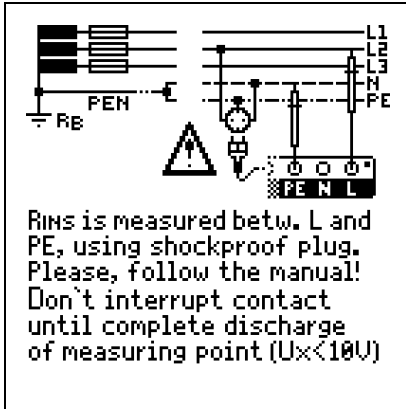

Note

If you use the country-specific measuring adapter, insulation resistance is only measured between the phase conductor terminal designated "L" and the protective conductor terminal PE!



Note

Checking Measurement Cables Before Measurements

Before performing insulation measurement, the test probes on the measurement cables should be short-circuited in order to assure that the instrument displays a value of less than 1 kΩ. In this way, incorrect connection can be avoided and broken measurement cables can be detected.

Set Parameters

500V Test voltage: 50 V / 100 V / 250 V / 325 V / 500 V / 1000 V
xxx V*

500V Uiso

Voltage type: constant

Voltage type: rising/ramp

Earth leakage resistance:

* Freely adjustable voltage (see section 5.7)

Polarity Selection

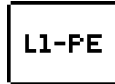

2-pole measurement (selection relevant for report generating only), **measurements between:**

Lx-PE / N-PE / L+N-PE / Lx-N / Lx-Ly / AUTO*

where x, y = 1, 2, 3

* AUTO parameter (see section 5.8)

Breakdown Current for Ramp Function

I_{LIM} U_{INS} (U_{INS})

Limit Value: I: 1.00mA

I > I_{Limit} STOP

Limit Values for Breakdown Voltage

Limits U_{INS} (U_{INS})

Lower limit value: U: >250V

Upper limit value: U: <750V

Enterable range: 40 to 999 V

Limit Values for Constant Test Voltage

Limits U_{INS} (U_{INS})

Limit Value: R: >1.0MΩ

R_{INS} < Limit Value LIMIT

Test voltage

A test voltage which deviates from nominal voltage, and is usually lower, can be selected for measurements at sensitive components, as well as systems with voltage limiting devices.

Voltage type

The "U_{INS}" rising test voltage function (ramp function) is used to detect weak points in the insulation, as well as to determine response voltage for voltage limiting components. After pressing the ON/START key, test voltage is continuously increased until the specified nominal voltage U_N is reached. U is the voltage which is measured at the test probes **during and after testing**. This voltage drops to a value of less than 10 V (see section entitled "Discharging the Device Under Test").

Insulation measurement with rising test voltage is ended:

- As soon as specified maximum test voltage U_N is reached and the measured value is stable

or

- As soon as specified maximum test voltage is reached (e.g. after sparkover occurs at breakdown voltage).

Specified maximum test voltage U_N or any occurring **triggering or breakdown voltage** is displayed for U_{INS}.

The constant test voltage function offers two options:

- **After briefly pressing the ON/START key**, specified test voltage U_N is read out and insulation resistance R_{INS} is measured. As soon as the measured value is stable (settling time may be several seconds in the case of high cable capacitance values), measurement is ended and the last measured values for R_{INS} and U_{INS} are displayed. U is the voltage which is measured at the test probes **during and after testing**. This voltage drops to a value of less than 10 V (see section entitled “Discharging the Device Under Test”).

or

- **As long as you press the ON/START key**, test voltage U_N is applied and insulation resistance R_{INS} is measured. Do not release the key until the measured value has settled in (settling time may be several seconds in the case of high cable capacitance values). Voltage U , which is measured during testing, corresponds to voltage U_{INS} . After releasing the ON/START key, measurement is ended and the last measured values for R_{INS} and U_{INS} are displayed. U drops to a value of less than 10 V after measurement (see the section entitled “Discharging the Device Under Test”).

□ Pole Selection Report Entry

The poles between which testing takes place can only be entered here for reporting purposes. The entry itself has no influence on the actual polarity of the test probes or the pole selection.

□ Limits – Setting the Limit Value

The limit value for insulation resistance can be set as desired. If measurement values occur which are below this limit value, the red **LIMIT LED** lights up. A selection of limit values ranging from 0.5 MΩ to 10 MΩ is available. The limit value is displayed above the measured value.

Start Measurement – Rising Test Voltage (ramp function)

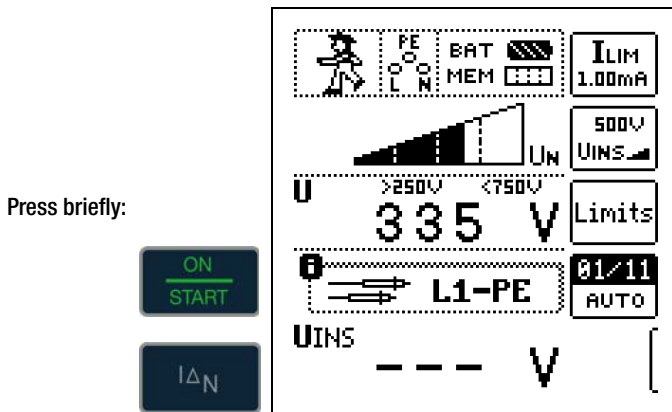

Quick polarity reversal if parameter is set to AUTO: 01/10 ... 10/10:
L1-PE ... L1-L3



Note

If “semiautomatic polarity reversal” is selected (see section 5.8), the corresponding icon is displayed instead of the ramp.

General Notes Regarding Insulation Measurements with Ramp Function

Insulation measurement with ramp function serves the following purposes:

- Detect weak points in the test object’s insulation.
- Determine tripping voltage of voltage limiting components and test them for correct functioning. These components may include, for example, varistors, overvoltage limiters (e.g. DEHNguard® from Dehn+Söhne) and spark gaps.

The test instrument uses continuously rising test voltage for this measuring function, up to the maximum selected voltage limit.

The measuring procedure is started by pressing the ON/START key and runs automatically until one of the following events occurs:

- The selected voltage limit is reached
 - The selected current limit is reached
- or
- Sparkover occurs (spark gaps)

Differentiation is made amongst the following three procedures for insulation measurement with ramp function:

Testing overvoltage limiters or varistors and determining their tripping voltage:

- Select maximum voltage such that the anticipated breakdown voltage of the device under test is roughly one third of this value (observe manufacturer’s data sheet if applicable).
- Select current limit value in accordance with actual requirements or the manufacturer’s data sheet (characteristic curve of the device under test).

Determining tripping voltage for spark gaps:

- Select maximum voltage such that the anticipated breakdown voltage of the device under test is roughly one third of this value (observe manufacturer’s data sheet if applicable).
- Select the current limit value in accordance with actual requirements within a range of 5 to 10 μA (response characteristics are too unstable with larger current limit values, which may result in faulty measurement results).

Detect weak points in the insulation:

- Select maximum voltage such that it does not exceed the test object’s permissible insulation voltage; it can be assumed that an insulation fault will occur even with a significantly lower voltage if an accordingly lower maximum voltage value is selected (nevertheless at least greater than anticipated breakdown voltage) – the ramp is less steep as a result (increased measuring accuracy).
- Select the current limit value in accordance with actual requirements within a range of 5 to 10 μA (see also settings for spark gaps).

Start Measurement – Constant Test Voltage

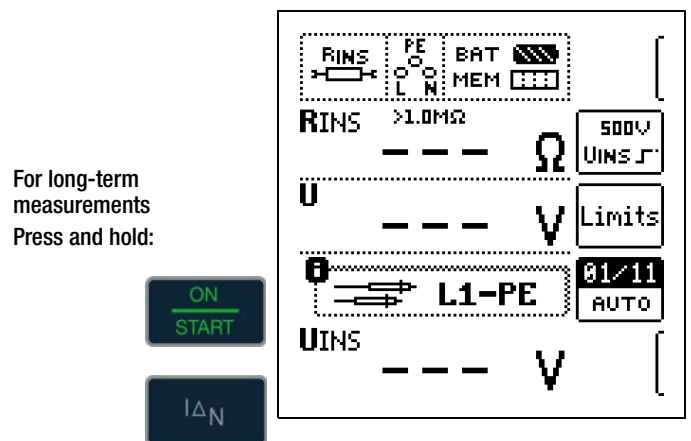

Quick polarity reversal if parameter is set to AUTO: 01/10 ... 10/10:
L1-PE ... L1-L3



Note

The instrument’s (rechargeable) batteries are exposed to excessive stress during insulation resistance measurement. When using the “constant test voltage” function, only press and hold the ON/START key until the display has become stable (if long-term measurement is required).

Special Condition for Insulation Resistance Measurement



Attention!

Insulation resistance can only be measured at voltage-free objects.

If measured insulation resistance is less than the selected limit value, the **LIMIT LED** lights up.

If an interference voltage of ≥ 25 V is present within the system, insulation resistance is not measured. The **MAINS/NETZ LED** lights up and the "interference voltage" pop-up message appears.

All conductors (L1, L2, L3 and N) must be tested against PE!



Attention!

Do not touch the instrument's terminal contacts during insulation resistance measurements!

If nothing has been connected to the terminal contacts, or if a resistive load component has been connected for measurement, your body would be exposed to a current of approximately 1 mA at a voltage of 1000 V. However, the resultant perceptible shock may lead to injury (e.g. resulting from a startled reaction etc.).

Discharging the Device Under Test



Attention!

If measurement is performed at a capacitive object such as a long cable, it becomes charged with up to approx. 1000 V! **Touching such objects is life endangering!**

When an insulation resistance measurement has been performed on a capacitive object it's automatically discharged by the instrument after measurement has been completed. Contact with the device under test must be maintained to this end. The falling voltage value can be observed at the U display.

Do not disconnect the DUT until less than 10 V is displayed for U!

Evaluation of Measured Values

Instrument measuring error must be taken into consideration in order to assure that the limit values set forth in DIN VDE regulations are not fallen short of. The required minimum display values for insulation resistance can be determined with the help of Table 3 on page 54. These values take maximum device error into consideration (under nominal conditions of use). Intermediate values can be interpolated.

11.2 Special Case: Earth Leakage Resistance (REINS)

This measurement is performed in order to determine electrostatic discharge capacity for floor coverings in accordance with EN 1081.

Select the Measuring Function

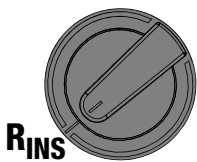

Set Parameters

* Freely adjustable voltage (see section 5.7)

Connection and Test Setup



- Measuring of earth leakage resistance $R_{E(ISO)}$ with 100Vdc
- Use probe according to EN 1081.
- Use 2-pole adapter!
- Press and hold **START** until measured value is stable.

- ◇ Rub the floor covering at the point at which measurement is to be performed with a dry cloth.
- ◇ Place the 1081 floor probe onto the point of measurement and load it with a weight of at least 300 N (30 kg). This corresponds to standard EN 1081. A load with 750 N (75 kg) conforms to standard DIN VDE 0100-600.
- ◇ Establish a conductive connection between the measuring electrode and the test probe and connect the measuring adapter (2-pole) to an earth contact, e.g. the earthing contact at a mains outlet or a central heating radiator (prerequisite: reliable ground connection).

Start Measurement



The limit value for earth leakage resistance from the relevant regulations applies.

12 Measuring Low-Value Resistance up to 200 Ohm (protective conductor and equipotential bonding conductor)

According to the regulations, the measurement of low-value resistance at protective conductors, earth conductors and bonding conductors must be performed with (automatic) polarity reversal of the test voltage, or with current flow in one direction (+ pole to PE) and then the other (- pole an PE).



Attention!

Low-resistance may only be measured at voltage-free objects.

Select the Measuring Function

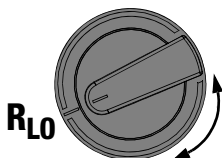

Connection

2-pole

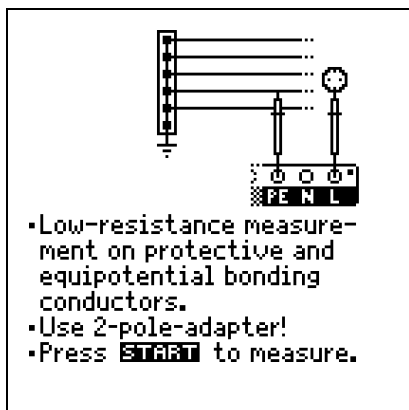

- Low-resistance measurement on protective and equipotential bonding conductors.
- Use 2-pole-adapter!
- Press **START** to measure.

Compensation for Measurement Cables up to 10 Ω

If measurement cables or extension cables are used, their resistance can be deducted automatically from the measurement results. Proceed as follows:

Measuring ROFFSET

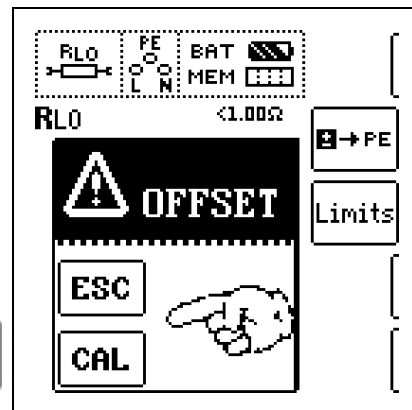

- Select a polarity option or automatic polarity reversal.
- Open the **OFFSET** menu by pressing $I_{\Delta N}$.
- Using the **PRO-Schuko measuring adapter (Z503K)**: Short circuit the L and N contacts at the test plug by inserting it into the short-circuiting jumper (PRO-JUMPER, Z503J).
- Using the **KS-PROFITEST INTRO (Z503L) or Z550A**: Short circuit the test probes of the connected, and if applicable extended, test leads by inserting the test probes into the short-circuiting jumper (PRO-JUMPER, Z503J).
- Start measurement of offset resistance with $I_{\Delta N}$ or **CAL**.



Note

If offset measurement is stopped upon appearance of a pop-up error window (Roffset > 10 Ω or difference between RLO+ and RLO- greater than 10%), the last measured offset value is retained. Inadvertent deletion of a previously ascertained offset value is thus practically ruled out! The respectively smaller value is otherwise stored to memory as an offset value. The maximum offset value is 10.0 Ω. Negative resistances may result due to the offset value.

Set Parameters

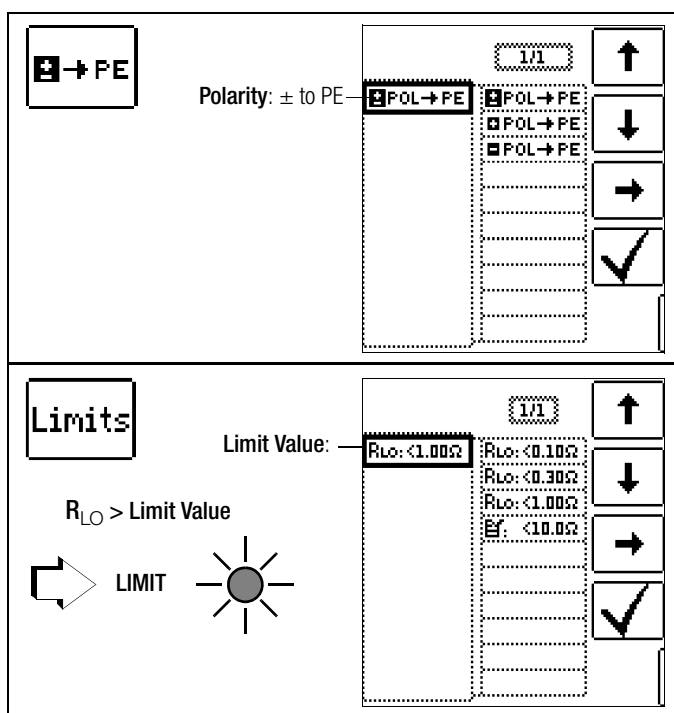

The **ROFFSET x.xx Ω** message now appears in the footer at the display, where x.xx is a value between 0.00 and 10.0 Ω. This value will now be deducted from the actual measurement value for all subsequent R_{LO} measurements.

When switching amongst polarity options, **ROFFSET** is reset to 0.00 Ω and must be determined again.

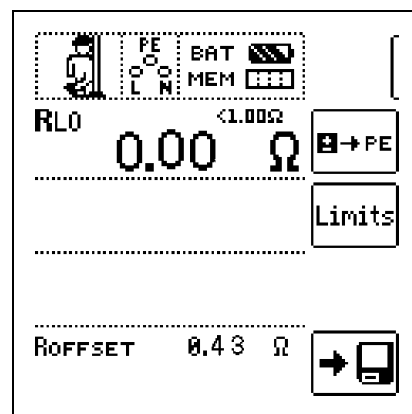

Note

Use this function in general for all measurement cables. Whenever different extension and measurement and cables are used, the above described procedure must always be repeated.

□ Type / Polarity

The direction in which current flows can be selected here.

□ Limits – Setting the Limit Value

The limit value for resistance can be set as desired. If measured values occur which are above this limit value, the red **LIMIT LED** lights up. Limit values can be selected within a range of 0.10 Ω to 10.0 Ω (editable). The limit value is displayed above the measured value.

12.1 Measurement with Constant Test Current

Start Measurement

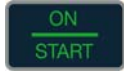

Press and hold for long-term measurement

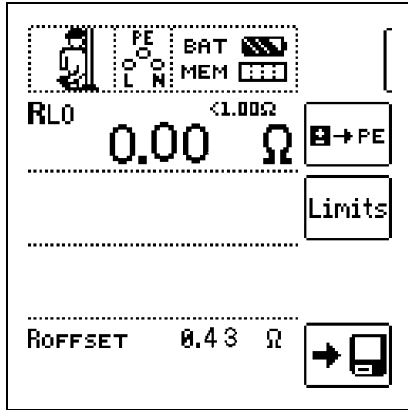

Attention!

The test probes should always be in contact with the DUT before the ON/START key is activated.
 If the object is energized, measurement is disabled as soon as it is contacted with the test probes.
 If the ON/START key is pressed first and the test object is contacted with the test probes afterwards, the fuse blows.

In the case of single-pole measurement, the respective value is saved to the database as RLO.

Polarity Selection	Display	Condition
+ pole to PE	RLO+	None
- pole to PE	RLO-	None
± pole to PE	RLO	Where $\Delta RLO \leq 10\%$
	RLO+ RLO-	Where $\Delta RLO > 10\%$

Automatic Polarity Reversal

After the measuring sequence has been started, the instrument performs measurement with automatic polarity reversal, first with current flow in one direction, and then in the other. In the case of long-term measurement (press and hold the ON/START key), polarity is switched once per second.

If the difference between RLO+ and RLO- is greater than 10% with automatic polarity reversal, RLO+ and RLO- values are displayed instead of RLO. The respectively larger value, RLO+ or RLO-, appears at the top and is saved to the database as the RLO value.

Evaluating Measurement Results

Differing results for measurements in both directions indicate voltage at the DUT (e.g. thermovoltages or unit voltages).

13 Special Functions – EXTRA Switch Position

Select the EXTRA Switch Position



13.1 Voltage Drop Measurement (at Z_{L-N}) – Function ΔU

Significance and Display of ΔU (per DIN VDE 100-600)

Voltage drop from the intersection of the distribution network and the consumer system to the point of connection of an electrical power consumer (electrical outlet or device connector terminals) should not exceed 5% of nominal line voltage.

Calculating voltage drop (without offset):

$$\Delta U = Z_{L-N} \cdot \text{nominal current of the fuse}$$

Calculating voltage drop (with offset):

$$\Delta U = (Z_{L-N} - Z_{\text{OFFSET}}) \cdot \text{nominal current of the fuse}$$

$$\Delta U \text{ in } \% = 100 \cdot \Delta U / U_{L-N}$$

See also section 9 regarding measurement procedure and connection.

Connection and Test Setup

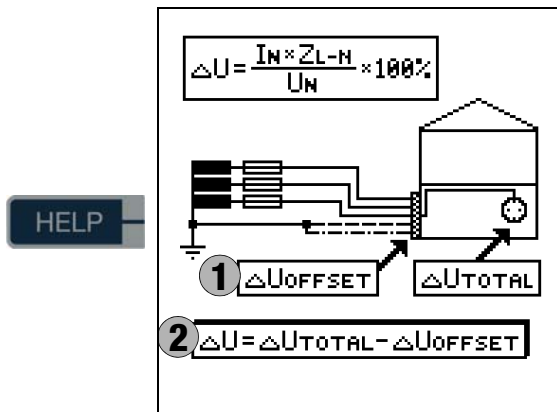

Set Parameters

L1-N	L1-N
L2-N	L2-N
L3-N	L3-N
L1-L2	L1-L2
L2-L3	L2-L3
L1-L3	L1-L3
L-N	L-N

Note: If nominal current I_N is changed by prevailing ΔU_{OFFSET} , the offset value is automatically adapted.

Setting Limit Values

- TAB Limit value per German technical connection conditions for connection to low-voltage mains between the distribution network and the measuring device
- DIN Limit value per DIN 18015-1: $\Delta U < 3\%$ between the measuring device and the consuming device
- VDE Limit value per DIN VDE 0100-520: $\Delta U < 5\%$ between the distribution network and the consuming device (adjustable up to 10% in this case)
- NL Limit value per NIV: $\Delta U < 5\%$

Start Measurement without OFFSET

Proceed as follows:

- Switch **OFFSET** from ON to OFF.

Determining RLN OFFSET

Depending on which measurement cable or measuring adapter is connected, an offset measurement must first be performed in the **SETUP** switch position (see page 12). The offset value ascertained in this way is displayed in the footer as **RLN OFFSET** and is subtracted from the measurement results.

Start Measurement with OFFSET

14 Database

14.1 Creating Distributor Structures, General

A complete distributor structure with data for electrical circuits and RCDs can be created in the **PROFITEST INTRO** test instrument. This structure makes it possible to assign measurements to the electrical circuits of various distributors, buildings and customers.

There are two possible procedures:

- On location or at the construction site: create the distributor structure in the test instrument. A distributor structure with up to 50,000 structure elements can be created in the test instrument, which is saved to the instrument's flash memory.

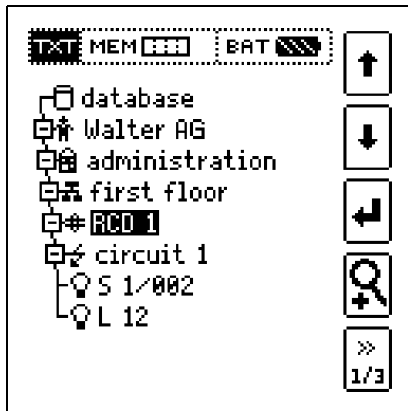

or

- Create and save an image of an existing distributor structure at a PC with the help of **ETC report generating software** (Electric Testing Center) – see Help > Getting Started (F1). The distributor structure is then transferred to the test instrument.

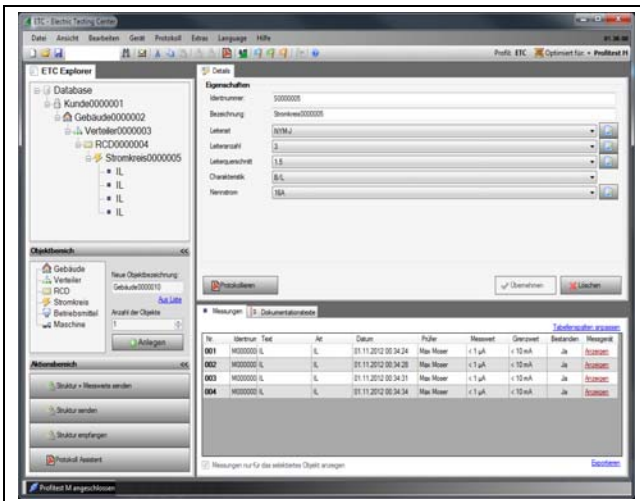

Note regarding ETC Report Generating Software

The following steps must be completed before using the software:

- Installing the USB Device Driver** (required for operation of the **PROFITEST INTRO** at a PC): **GMC-I Driver Control** software for installing the USB device driver can be downloaded from our website: <http://www.gossenmetrawatt.com> → Products → Software → Software for Testers → Utilities → **Driver Control**
- Install ETC report generating software:** The most up-to-date version of ETC can be downloaded free of charge from the **mygmc** page of our website as a ZIP file, if you have registered your test instrument:

<http://www.gossenmetrawatt.com>
 → Products → Software → Software for Testers
 → Report Software without Database → **ETC**
 → **myGMC** → [to Login](#)

14.2 Transferring Distributor Structures

The following data transfer operations are possible:

- Transfer a distributor structure from the PC to the test instrument.
- Transfer a distributor structure including measured values from the test instrument to the PC.

The test instrument and the PC must be connected with a USB cable in order to transfer structures and data.

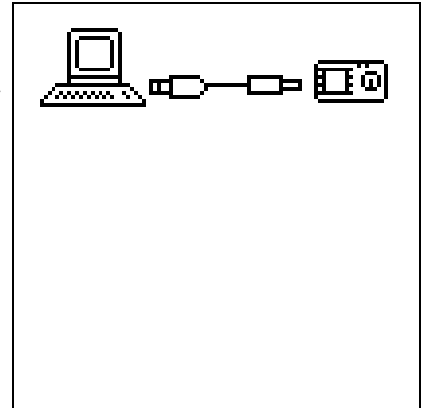

The following image appears at the display during transfer of structures and data.

14.3 Creating a Distributor Structure in the Test Instrument

Overview of the Meanings of Icons used to Create Structures

Symbol	Meaning
Main Level	Sub-Level
Memory menu, page 1 of 3	
	Cursor UP: scroll up
	Cursor DOWN: scroll down
	ENTER: acknowledge selection + → – change to sub-level (open directory) or – → + change to main level (close directory)
	Display the complete structure designation (max. 63 characters) or ID number (25 characters) in a zoom window
	Temporarily switch back and forth between structure designation and ID number. These keys don't have any effect on the main setting in the setup menu (see "DB Mode" on page 11).
	Hide the zoom window
	Change display to menu selection
Memory menu, page 2 of 3	
	Add a structure element
	Meanings of icons from top to bottom: Customer, building, distributor, RCD, electrical circuit, operating equipment, machine and earth electrode (display of the icons depends on the selected structure element). Selection: UP/DOWN scroll keys and ↵ In order to add a designation to the selected structure element, refer to the edit menu in following column.
	EDIT
	Delete the selected structure element.

Symbol	Meaning
	Show measurement data, if a measurement has been performed for this structure element.
	Edit the selected structure element.
Memory menu, page 3 of 3	
	Search for ID number > Enter complete ID number.
	Search for text. > Enter full text (complete word).
	Search for ID number or text.
	Continue searching.
Edit menu	
	Cursor LEFT: Select an alphanumeric character
	Cursor RIGHT: Select an alphanumeric character
	ENTER: accept an individual character
<input checked="" type="checkbox"/>	Acknowledge entry
←	Scroll left
→	Scroll right
	Delete characters.
	Switching amongst different types of alphanumeric characters:
A	✓ ABCDEFGHIJK Upper case letters LMNOPQRSTUVWXYZ↵↔
a	✓ abcdefghijk Lower case letters lmnopqrstuvwxyz↵↔
0	✓ 0123456789+ Numbers -*/=:;_<>↵↔
@	✓ @#Aa00UuR€\$% Special characters &#ááééííóóúú↵↔

Distributor Structure Symbology / Tree Structure

A **check mark** to the right of a structure element means that all measurements within the respective hierarchy have been passed.
x: At least one measurement has not been passed.
No symbol: Measurement has not yet been performed.

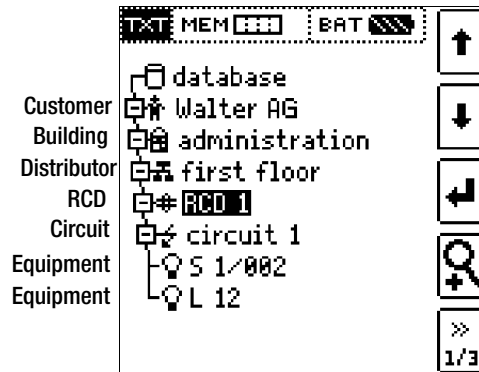

Same type of element as in the Windows Explorer:
+ : sub-objects available, display by pressing ↵.
- : sub-objects are displayed, hide by pressing ↵.

14.3.1 Creating Structures (example for electrical circuit)

After selection with the **MEM** key, all setting options for the creation of a tree structure are made available on three menu pages (1/3, 2/3 and 3/3). The tree structure consists of structure elements, referred to below as objects.

Select the position at which a new object will be added.

Use the ↑↓ keys in order to select structure elements.
Change to the sub-level with the ↵ key.
Go to the next page with the >> key

Creating a New Object

Press the key in order to create a new object.

Select a new object from a list.

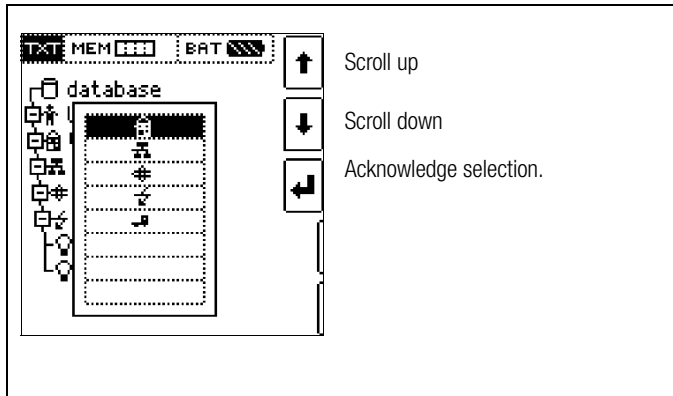

- ↑ Scroll up
- ↓ Scroll down
- ↵ Acknowledge selection.

Select the desired object from the list with the ↑↓ keys and acknowledge with the ↵ key.

Depending upon the profile selected in the test instrument's SETUP menu (see section 4.5), the number of object types may be limited, and the hierarchy may be laid out differently.

Enter a designation.

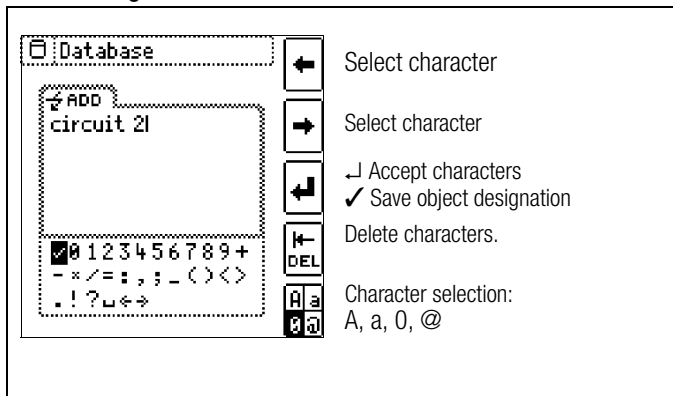

- ← Select character
- Select character
- ↵ Accept characters
- ✓ Save object designation
- ↵ Delete characters.
- Character selection:
A, a, 0, @

Enter a designation and then acknowledge it by pressing ✓.

Note

Acknowledge the standard or adjusted parameters shown below, because the created designation will otherwise not be accepted and saved.

Set Electrical Circuit Parameters

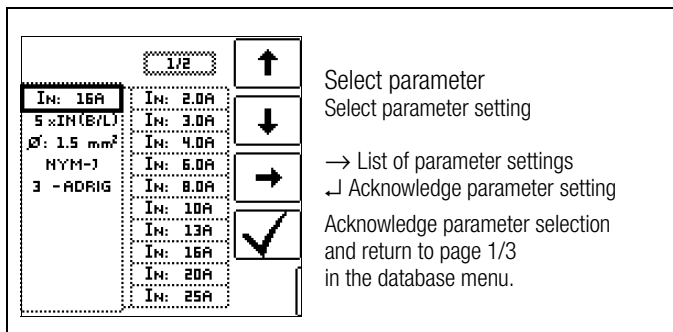

- ↑ Select parameter
- ↓ Select parameter setting
- List of parameter settings
- ↵ Acknowledge parameter setting
- ✓ Acknowledge parameter selection and return to page 1/3 in the database menu.

For example, nominal current values must be entered here for the selected electrical circuit. Measuring parameters which have been accepted and saved in this way are subsequently accepted by the current measuring menu automatically when the display is switched from the structure view to measurement.

Note

Electrical circuit parameters changed during structure creation are also retained for individual measurements (measurement without saving data).

If you change the electrical circuit parameter specified by the structure in the test instrument, a warning is displayed when the change is saved (see error message on page 48).

14.3.2 Searching for Structure Elements

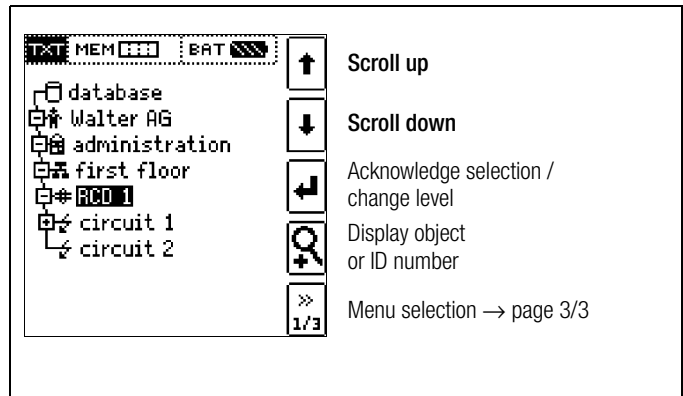

- ↑ Scroll up
- ↓ Scroll down
- ↵ Acknowledge selection / change level
- 🔍 Display object or ID number
- Menu selection → page 3/3

Regardless of the currently selected object, the search is started at **database**.

Go to page 3/3 in the database menu.

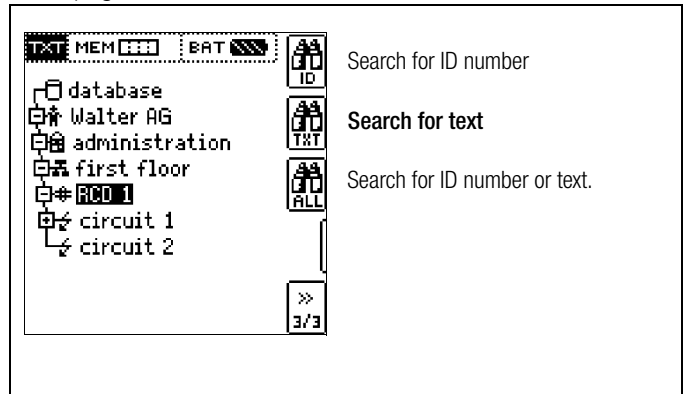

- ID Search for ID number
- TXT Search for text
- ALL Search for ID number or text.

After selecting text search ...

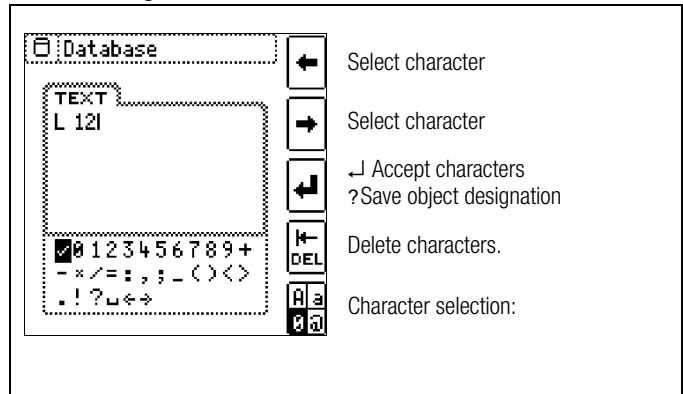

- ← Select character
- Select character
- ↵ Accept characters
- ? Save object designation
- ↵ Delete characters.
- Character selection:

... and entering the desired text (only full matches are found – no wild cards, case sensitive) ...

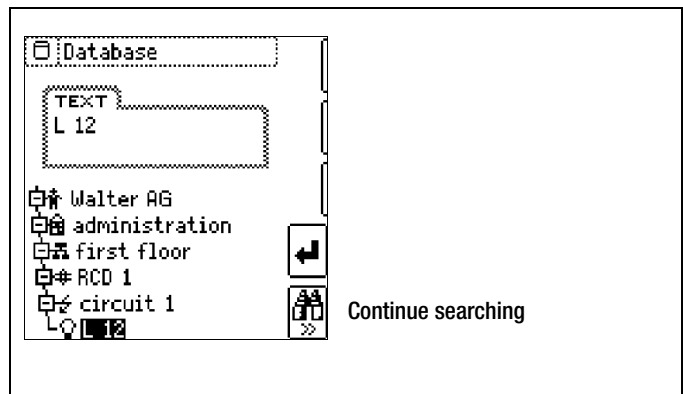

Continue searching

... the first match is displayed.

Further matches can be found by selecting the icon shown at the right.



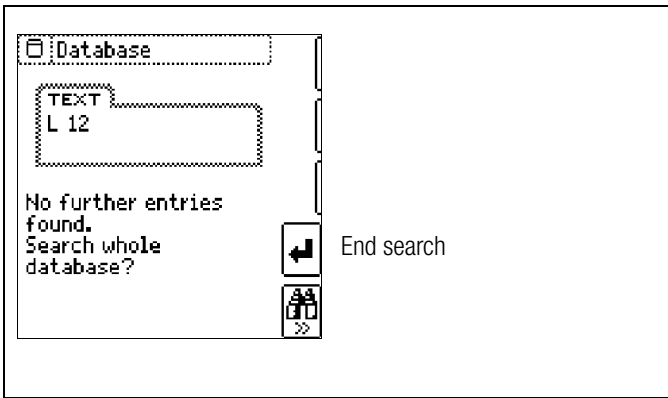

If no further matches are found, the message shown above is displayed.

14.4 Saving Data and Generating Reports

Preparing and Executing a Measurement

Measurements can be performed and stored to memory for each structure element. Proceed as follows, adhering to the prescribed sequence:

- ⇒ Select the desired measurement with the rotary knob.
 - ⇒ Start the measurement by pressing the **ON/START** or Δ N key.
- Upon completion of measurement, the "→ Floppy Disk" softkey is displayed.
- ⇒ **Briefly** press the "Save Value" key.



The display is switched to the memory menu or the structure view.

- ⇒ Navigate to the desired memory location, i.e. to the desired structure element / object, for which the measurement data will be saved.
- ⇒ If you would like to save a comment along with the measurement, press the key shown at the right and enter a designation via the "EDIT" menu as described in section 14.3.1.
- ⇒ Complete data storage by pressing the "STORE" key.



Saving Error Messages (pop-ups)

If a measurement is ended without a measured value due to an error, the measurement can be saved along with the pop-up by pressing the "Save Value" key. The corresponding text is read out in ETC instead of the pop-up symbol. This only applies to a limited number of pop-ups (see below). Neither a symbol nor a text can be accessed in the test instrument's database itself.

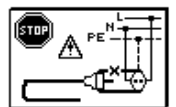
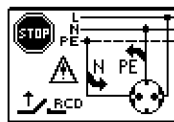
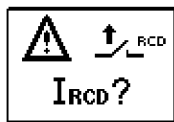
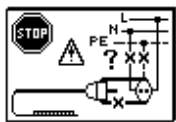

Alternative Storage Procedure

- ⇒ The measured value can be saved to the last selected object in the structure diagram by **pressing and holding** the "Save Value" key, without switching the display to the memory menu.



Note

If you change the parameters in the measurement view, they are not saved for the structure element. A measurement with changed parameters can nevertheless be saved to the structure element, and any changed parameters are documented in the report for each measurement.

Retrieving Saved Measured Values

- ⇒ Switch the display to the distributor structure by pressing the **MEM** key and select the desired electrical circuit with the scroll keys.
- ⇒ Switch to page 2 by pressing the key shown here:
- ⇒ Display the measurement data by pressing the key shown here:



One measurement with date and time, as well as any comment you might have entered, is displayed in each screen.

Example:
RCD Measurement

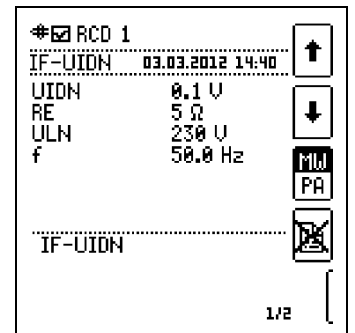

Note

A check mark in the header means that the respective measurement has been passed. An X means that the measurement has not been passed.

- ⇒ Scrolling amongst measurements is possible with the keys shown here:
- ⇒ The measurement can be deleted with the key shown here:



A prompt window asks you to confirm deletion.



With the help of the key shown at the right (MW: measured value / PA: parameter), the setting parameters can be displayed for this measurement.

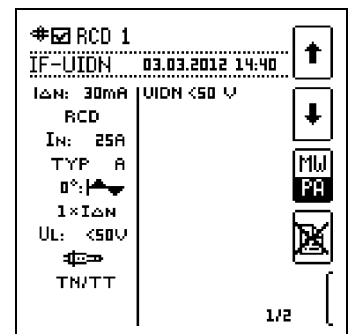

- ⇒ Scrolling amongst measurements is possible with the keys shown here:



Data Evaluation and Report Generation with ETC Software

All data, including the distributor structure, can be transferred to the PC and evaluated with the help of ETC software. Additional information can be entered here subsequently for the individual measurements. After pressing the appropriate key, a report including all measurements within a given distributor structure is generated, or the data are exported to an Excel spreadsheet.

Note

The database is exited when the rotary selector switch is turned. Previously selected parameters in the database are not used for the measurement.

14.4.1 Use of Barcode Scanners and RFID Readers

Search for an Already Scanned Barcode

The search can be started from any switch setting and menu.

➤ Scan the object's barcode.

The found barcode is displayed inversely.

➤ This value is accepted after pressing the ENTER key.

Note

A previously selected object is not taken into consideration by the search.

Continued Searching in General



Regardless of whether or not an object has been found, searching can be continued by pressing the key shown at the left:

- Object found: Searching is continued underneath the previously selected object.
- No further object found: The entire database is searched at all levels.

Reading In a Barcode for Editing

If the menu for alphanumeric entry is active, any value scanned by means of a barcode or RFID reader is accepted directly.

Using a Barcode Printer (accessory)

A barcode printer allows for the following applications:

- Read-out of ID numbers as barcodes, encrypted; for quick and convenient acquisition for periodic testing
- Print-out of repeatedly occurring designations such as test object types encrypted as barcodes in a list, allowing them to be read in as required for comments

15 Attaching the Test Probe Holder to the Carrying Strap

- 1** Detach the strap from the instrument: Turn out the slotted screw (M3) at the bottom.

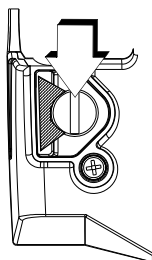

Bottom Left

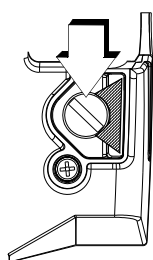

Bottom Right



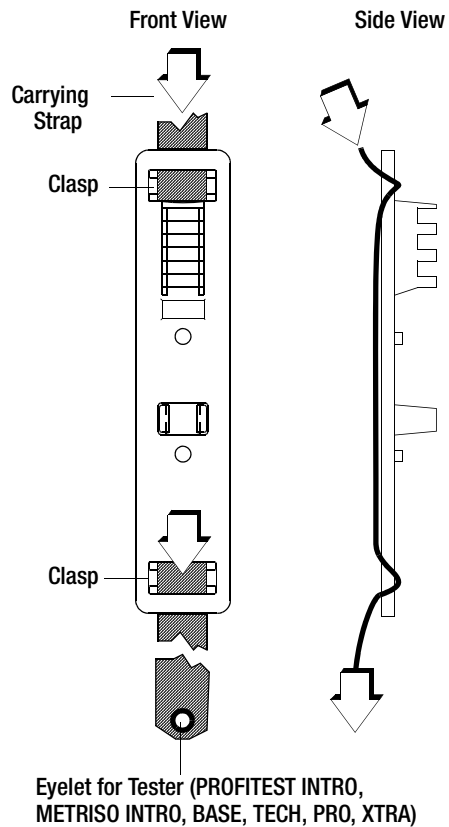



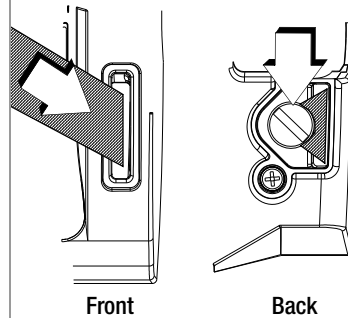

- 2** Slide the strap through the test probe holder.























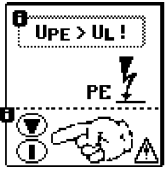

- 3** Feed the strap through from the front of the test instrument and secure it with the slotted screw (M3).

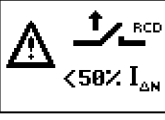

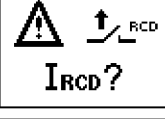

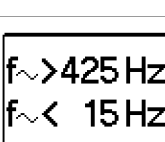
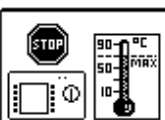
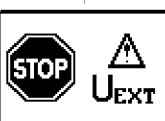







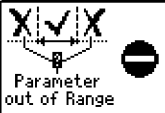

16 LED Indications, Mains Connections and Potential Differences



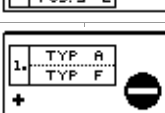



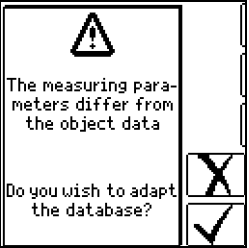
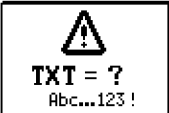

	Status	Error No.	Position of the Function Switch	Function / Meaning
LED Signals				
MAINS/NETZ	Lights up green	Ic1 (Ic = line control)	$I_{\Delta N} / I_F \triangleleft$ $Z_{L-N} / Z_{L-PE} / R_E$ ΔU , int. ramp, EXTRA	Correct connection, measurement enabled
MAINS/NETZ	Blinks green	Ic2	$I_{\Delta N} / I_F \triangleleft$ $Z_{L-N} / Z_{L-PE} / R_E$ ΔU , int. ramp	N conductor not connected, measurement enabled
MAINS/NETZ	Lights up orange	Ic3	$I_{\Delta N} / I_F \triangleleft$ $Z_{L-N} / Z_{L-PE} / R_E$	Line voltage of 65 V to 253 V to PE, 2 different phases active (no neutral conductor at mains), measurement enabled
MAINS/NETZ	Blinks red	Ic4	$I_{\Delta N} / I_F \triangleleft$ $Z_{L-N} / Z_{L-PE} / R_E$ ΔU , int. ramp	1) No line voltage or 2) PE interrupted
MAINS/NETZ	Lights up red	Ic5	RINS / RLO	Interference voltage detected, measurement disabled
MAINS/NETZ	Blinks Yellow	Ic6	$I_{\Delta N} / I_F \triangleleft$ $Z_{L-N} / Z_{L-PE} / R_E$	L and N are connected to the phase conductors.
LIMIT	Lights up red	Ic7	$I_{\Delta N}$	– Touch voltage $U_{I\Delta N}$ and $U_{I\Delta} > 25$ V respectively > 50 V – After safety shutdown
LIMIT	Lights up red	Ic8	$I_F \triangleleft$ int. ramp	– With rising residual current, the RCD is not tripped before reaching I_N . – After safety shutdown
LIMIT	Lights up red	Ic9	RINS / RLO	– Limit value exceeded or fallen short of
Mains Connection Test — Single-Phase System — LCD Connection Pictographs				
	Is displayed	Ic10	All except for U	No connection detected
	Is displayed	Ic11	All except for U	Connection OK
	Is displayed	Ic12	All except for U	L and N reversed, neutral conductor charged with phase voltage
	Is displayed	Ic13	All except U and RE	No mains connection
			RE	Standard display without connection messages
	Is displayed	Ic14	All except for U	Neutral conductor interrupted
	Is displayed	Ic15	All except for U	Protective conductor PE interrupted, neutral conductor N and/or phase conductor L charged with phase voltage
	Is displayed	Ic16	All except for U	Phase conductor L interrupted, neutral conductor N charged with phase voltage
	Is displayed	Ic17	All except for U	Phase conductor L and protective conductor PE reversed
	Is displayed	Ic19	All except for U	L and N are connected to the phase conductors.

	Status	Error No.	Position of the Function Switch	Function / Meaning
Mains Connection Test — 3-Phase System — LCD Connection Pictographs				
	Is displayed	Ic20	U (3-phase measurement)	Clockwise rotation
	Is displayed	Ic21	U (3-phase measurement)	Counter-clockwise rotation
	Is displayed	Ic22	U (3-phase measurement)	Short between L1 and L2
	Is displayed	Ic23	U (3-phase measurement)	Short between L1 and L3
	Is displayed	Ic24	U (3-phase measurement)	Short between L2 and L3
	Is displayed	Ic25	U (3-phase measurement)	Conductor L1 missing
	Is displayed	Ic26	U (3-phase measurement)	Conductor L2 missing
	Is displayed	Ic27	U (3-phase measurement)	Conductor L3 missing
	Is displayed	Ic28	U (3-phase measurement)	Conductor L1 to N
	Is displayed	Ic29	U (3-phase measurement)	Conductor L2 to N
	Is displayed	Ic30	U (3-phase measurement)	Conductor L3 to N
Battery Test				
	Is displayed		All	Safety Shutdown (Rechargeable) battery voltage is less than or equal to 8.0 V. Reliable measurement is no longer possible. Storage of measured values to memory is disabled. Remedy: Rechargeable NiMH batteries must be recharged, or batteries must be replaced towards the end of their service life.
PE Test				
LCD	LED			
	LIMIT Lights up red		U (single-phase measurement)	Potential difference ≥ 45 V to PE (earthing contact) Frequency $f \geq 50$ Hz or If L is correctly contacted and PE is interrupted (frequency $f \geq 50$ Hz)
Is displayed				

Status	Error No.	Position of the Function Switch	Function / Meaning
Error Messages— LCD Connection Pictographs			
	Err1	All measurements with protective conductor	Potential difference $\geq U_L$ PE (earthing contact) (frequency $f \geq 50$ Hz) Remedy: inspect PE connection Note: only if  appears: Measurement can nevertheless be started by pressing the ON/START key again.
	Err2	$I_{\Delta N} / I_{F\Delta}$ $Z_{L-N} / Z_{L-PE} / R_E$	1) Voltage too high ($U > 253$ V) for RCD test with direct current 2) U always $U > 550$ V with 500 mA 3) $U > 440$ V for $I_{\Delta N} / I_{F\Delta}$ 4) $U > 253$ V for $I_{\Delta N} / I_{F\Delta}$ with 500 mA
	Err3	$I_{\Delta N}$	RCD is tripped too early or is defective. Remedy: test circuit for bias current.
	Err4	Z_{L-PE}	RCD is tripped too early or is defective. Remedy: test with "DC + positive half-wave".
	Err5	$I_{\Delta N} / I_{F\Delta}$	RCD tripped during touch voltage measurement. Remedy: check selected nominal test current.
	Err6	EXTRA → PRCD	The PRCD has been tripped. Reason: poor contact or defective PRCD.
	Err7	All except for U	Externally accessible fuse is blown. The voltage ranges remain functional even if fuses have blown. Special case, R_{LO}: Interference voltage during measurement may result in a blown fuse. Remedy: replace fuse Observe notes regarding fuse replacement in section 18.3!
	Err8	$I_{\Delta N} / I_{F\Delta}$ $Z_{L-N} / Z_{L-PE} / R_E$	Frequency out of permissible range. Remedy: Inspect mains connection.
	Err9	All	Excessive temperature inside the test instrument. Remedy: wait for test instrument to cool down.
	Err9	R_{INS} / R_{LO}	Interference voltage Remedy: device under test must be disconnected from all sources of voltage.
	Err11	R_{INS} / R_{LO}	Overvoltage or overloading of the measuring voltage generator during measurement of R_{INS} or R_{LO}
	Err12	$I_{\Delta N} / I_{F\Delta}$ Z_{L-N} / Z_{L-PE} R_E	No mains connection. Remedy: inspect mains connection.
	Err13	R_{LO}	OFFSET measurement is not sensible. Remedy: check system. OFFSET measurement of R_{LO+} and R_{LO-} is still possible.

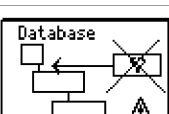
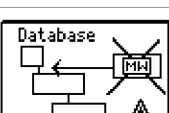
Status	Error No.	Position of the Function Switch	Function / Meaning																								
	Err14	SETUP	Resistance compensation for the connector cables: $R_{\text{OFFSET}} > 1 \Omega$: OFFSET measurement of RL-PE or RN-PE and RLN for ZL-PE and ZL-N is not sensible. Remedy: check system.																								
	Err15	R_{LO}	$R_{\text{OFFSET}} > 10 \Omega$: OFFSET measurement is not sensible. Remedy: check system.																								
	Err16	SETUP → OFFSET (EXTRA → ΔU)	$Z > 10 \Omega$: OFFSET measurement of RL-PE or RN-PE and RLN for ΔU(ZLN) is not sensible. Remedy: check system.																								
	Err17	EXTRA → ΔU	$\Delta U_{\text{OFFSET}} > \Delta U$: OFFSET value is greater than the measured value at the consuming system. OFFSET measurement is not sensible. Remedy: check system.																								
	Err18	RINS / RLO	Contact problem or blown fuse Remedy: check test plug or measuring adapter for correct seating in the test plug, or replace the fuse.																								
	Err19	R_{E}	Polarity of the test probes has to be reversed.																								
	Err20	$I_{\Delta N} / I_{\text{F}}$	N and PE are swapped.																								
	Err21	$I_{\Delta N} / I_{\text{F}}$ $Z_{\text{L-N}} / Z_{\text{L-PE}} / R_{\text{E}}$	1) Mains connection error Remedy: inspect mains connection. or 2) Display in the connection pictograph: PE interrupted (x) or bottom protective conductor tab interrupted with reference to the keys at the test plug Cause: voltage measuring path interrupted Result: measurement is disabled. Note: only if appears: Measurement can nevertheless be started by pressing the ON/START key again.																								
	Err22	$I_{\Delta N} / I_{\text{F}}$	Display in the connection pictograph: Top protective conductor tab interrupted with reference to the keys at the test plug Cause: current measuring path interrupted Result: no measured value display																								
	Err23	$I_{\Delta N} / I_{\text{F}}$	Resistance in the N-PE path is too high. <table border="1" data-bbox="598 1563 1358 1697"> <thead> <tr> <th></th> <th colspan="5">$I_{\Delta N} / I_{\text{F}}$</th> </tr> <tr> <th></th> <th>10 mA</th> <th>30 mA</th> <th>100 mA</th> <th>300 mA</th> <th>500 mA</th> </tr> </thead> <tbody> <tr> <td>R_{MAX} at $I_{\Delta N}$</td> <td>510 Ω</td> <td>170 Ω</td> <td>50 Ω</td> <td>15 Ω</td> <td>9 Ω</td> </tr> <tr> <td>R_{MAX} for I_{F}</td> <td>410 Ω</td> <td>140 Ω</td> <td>40 Ω</td> <td>12 Ω</td> <td>7 Ω</td> </tr> </tbody> </table> Consequence: The required test current cannot be generated and measurement is aborted.		$I_{\Delta N} / I_{\text{F}}$						10 mA	30 mA	100 mA	300 mA	500 mA	R_{MAX} at $I_{\Delta N}$	510 Ω	170 Ω	50 Ω	15 Ω	9 Ω	R_{MAX} for I_{F}	410 Ω	140 Ω	40 Ω	12 Ω	7 Ω
	$I_{\Delta N} / I_{\text{F}}$																										
	10 mA	30 mA	100 mA	300 mA	500 mA																						
R_{MAX} at $I_{\Delta N}$	510 Ω	170 Ω	50 Ω	15 Ω	9 Ω																						
R_{MAX} for I_{F}	410 Ω	140 Ω	40 Ω	12 Ω	7 Ω																						
	Err24	$Z_{\text{L-PE}}, R_{\text{E}}$	If specified touch voltage U_{L} is exceeded: $Z_{\text{L-PE}}$ and R_{E} : user is prompted to switch to the 15 mA wave. R_{E} alternative only: User is prompted to reduce the measuring range (reduce current.)																								

Status	Error No.	Position of the Function Switch	Function / Meaning
Entry Plausibility Check – Parameters Combination Checking — LCD Pictographs			
	Err25		Parameter out of permissible range
	Err26	$I_{\Delta N}$	5 x 500 mA is not possible
	Err27	$I_{\Delta N} / I_{F\Delta}$	Types B/B+ and EV/MI not possible with G/R, SRCD, PRCD
	Err28	$I_{\Delta N}$	180° not possible for G/R, SRCD, PRCD
	Err29	$I_{\Delta N} / I_{F\Delta}$	DC not possible with G/R, SRCD, PRCD
	Err30	$I_{\Delta N} / I_{F\Delta}$	Half-wave or DC not possible with type AC
	Err31	$I_{\Delta N} / I_{F\Delta}$	DC not possible with type A, F
	Err32	$I_{\Delta N}$	1/2 test current not possible with DC
	Err33	$I_{\Delta N}$	2 x / 5 x $I_{\Delta N}$ with full-wave only
	Err34	$I_{\Delta N} / I_{F\Delta}$	DC+ with 10 Ω only
	Err35	R_E	15 mA only possible in 1 kΩ and 100 Ω ranges!
	Err36	R_E	15 mA as loop measurement only
	Err37	All	The parameters you have selected do not make sense in combination with previously configured parameters. The selected parameter settings will not be saved. Remedy: enter other parameter settings.

Status	Error No.	Position of the Function Switch	Function / Meaning
Database and Entry Operations — LCD Pictographs			
	Err38	$I_{\Delta N} / I_{\Delta}$ Z_{L-N} / Z_{L-PE} EXTRA → $t_A + I_{\Delta}$	Measured Value Storage with Deviating Electrical Circuit Parameter The electrical circuit parameter selected by yourself at the test instrument does not coincide with the parameter entered under object data in the structure. Example: Residual operating current is specified as 10 mA in the database, but you have performed measurement with 100 mA. If you want to perform all future measurements with 100 mA, the value in the database has to be changed by acknowledging with the <input checked="" type="checkbox"/> key. The measured value is documented and the new parameter is accepted. If you want to leave the parameter in the database unchanged, press the X key. The measured value and the changed parameter are only documented in this case.
	Err39	All (page 39)	Please enter a designation (alphanumeric).
	Err40	All	Operation with a Barcode Scanner Error message when the "EDIT" entry field is opened and rechargeable battery voltage is less than 8.0 V. Output voltage is generally switched off during barcode scanner operation if U is less than 8.0 V, in order to assure that remaining battery capacity is adequate for entering designations for devices under test and saving the measurement. Remedy: rechargeable batteries must be recharged, or batteries must be replaced towards the end of their service life.
	Err41	All	Operation with a Barcode Scanner Current flowing through the RS 232 port is too high. Remedy: the connected device is not suitable for this port.
	Err42	All	Operation with a Barcode Scanner Barcode not recognized, incorrect syntax
	Err43	All	Data cannot be entered at this location within the structure. Remedy: observe profile for preselected PC software (see SETUP menu).
	Err44	All	Measured value cannot be saved at this location within the structure. Remedy: make sure that you have selected the right profile for you PC evaluation program in the SETUP menu (see section 4.5).
	Err45	All	Memory is full. Remedy: save your measurement data to a PC and then clear memory at test instrument by deleting the database or by importing an empty database.
	Err46	All	Delete measurement or database. This prompt window asks you to confirm deletion.
	Err47	SETUP	Data loss after changing language or profile, or after restoring default settings. Back up your measurement data to a PC before pressing the respective key. This prompt window asks you to confirm deletion.
	Err48	All	This error message appears if the database, i.e. the structure created in ETC, is too large for the instrument's internal memory. The database in the instrument's internal memory is empty after database transfer has been interrupted. Remedy: reduce the size of the database in ETC or transfer the database without measured values (Transmit Structure key), if measured values already exist.

17 Characteristic Values

Function	Measured quantity	Display Range	Resolution	Input Impedance / Test Current	Measuring Range	Nominal Values	Measuring Uncertainty	Intrinsic Uncertainty	Connections				
									PRO-Schuko Adapter	KS-PROFITEST INTRO 2-Pole	3-Pole		
U I _{ΔN} I _F	U _{L-PE} U _{N-PE}	0.0 ... 99.9 V 100 ... 600 V	0.1 V 1 V	5 MΩ	0.3 ... 600 V ¹	U _N = 120/230/400/500 V f _N = 16⅔/50/60/200/400 Hz	±(2% rdg.+5d) ±(2% rdg. + 1 d) ±(0.2% rdg. + 1 d)	±(1% rdg.+5d) ±(1% rdg. + 1 d) ±(0.1% rdg. + 1 d)	●	●	●		
	f	15.0 ... 99.9 Hz 100 ... 999 Hz	0.1 Hz 1 Hz		DC 15.4 ... 420 Hz								
	U ₃₋	0.0 ... 99.9 V 100 ... 600 V	0.1 V 1 V		0.3 ... 600 V				±(3% rdg.+5d) ±(3% rdg. + 1 d)	±(2% rdg.+5d) ±(2% rdg. + 1 d)		●	
	U _{L-N}	0.0 ... 99.9 V 100 ... 600 V	0.1 V 1 V		1.0 ... 600 V ¹				±(3% rdg.+5d) ±(3% rdg. + 1 d)	±(2% rdg.+5d) ±(2% rdg. + 1 d)	●		●
	U _{ΔN}	0.0 ... 70.0 V	0.1 V	0.3 · I _{ΔN}	5 ... 70 V			+13% rdg. + 1 d	+1% rdg. -1d +9% rdg. + 1 d				
	R _E	R _E	10 Ω ... 999 Ω 1.00 kΩ ... 6.51 kΩ	1 Ω 0.01 kΩ	I _{ΔN} = 10 mA · 1.05	Calculated value Off R _E = U _{ΔN} / I _{ΔN}	U _N = 120 V 230 V 400 V ² f _N = 50/60 Hz U _L = 25/50 V						
			3 Ω ... 999 Ω 1 kΩ ... 2.17 kΩ	1 Ω 0.01 kΩ	I _{ΔN} = 30 mA · 1.05								
			1 Ω ... 651 Ω	1 Ω	I _{ΔN} = 100 mA · 1.05								
			0.3 Ω ... 99.9 Ω 100 Ω ... 217 Ω	0.1 Ω 1 Ω	I _{ΔN} = 300 mA · 1.05								
			0.2 Ω ... 9.9 Ω 10 Ω ... 130 Ω	0.1 Ω 1 Ω	I _{ΔN} = 500 mA · 1.05								
	I _F (I _{ΔN} = 6 mA)	1.8 ... 7.8 mA	0.1 mA	1.8 ... 7.8 mA	1.8 ... 7.8 mA								
	I _F (I _{ΔN} = 10 mA)	3.0 ... 13.0 mA		3.0 ... 13.0 mA	3.0 ... 13.0 mA								
	I _F (I _{ΔN} = 30 mA)	9.0 ... 39.0 mA		9.0 ... 39.0 mA	9.0 ... 39.0 mA								
	I _F (I _{ΔN} = 100 mA)	30 ... 130 mA	1 mA	30 ... 130 mA	30 ... 130 mA			±(7% rdg. + 2 d)	±(3.5% rdg. + 2 d)				
	I _F (I _{ΔN} = 300 mA)	90 ... 390 mA	1 mA	90 ... 390 mA	90 ... 390 mA								
I _F (I _{ΔN} = 500 mA)	150 ... 650 mA	1 mA	150 ... 650 mA	150 ... 650 mA									
U _Δ / U _L = 25 V	0.0 ... 25.0 V	0.1 V	Same as I _Δ	0 ... 25.0 V			+10% rdg. + 1 d	+1% rdg. -1d +9% rdg.+ 1 d					
U _Δ / U _L = 50 V	0.0 ... 50.0 V			0 ... 50.0 V									
t _A (I _{ΔN} · 1)	0 ... 999 ms	1 ms	6 ... 500 mA	0 ... 999 ms									
t _A (I _{ΔN} · 2)	0 ... 999 ms	1 ms	2 · 6 ... 2 · 500 mA	0 ... 999 ms			±4 ms	±3 ms					
t _A (I _{ΔN} · 5)	0 ... 40 ms	1 ms	5 · 6 ... 5 · 300 mA	0 ... 40 ms									
Z _{L-PE} Z _{L-N}	Z _{L-PE} (AC) Z _{L-N}	0 ... 999 mΩ 1.00 ... 9.99 Ω	1 mΩ 0.01 Ω 0.1 Ω	1.3 ... 3.7 A AC 0.5/1.25 A DC	300 ... 999 mΩ 1.00 ... 9.99 Ω	U _N = 120/230 V 400/500 V ¹ f _N = 16⅔/50/60 Hz	±(10% rdg.+30d) ±(8% rdg.+3d)	±(5% rdg.+30d) ±(3% rdg.+3d)					
	Z _{L-PE} (AC) + DC	0 ... 999 mΩ 1.00 ... 9.99 Ω 10.0 ... 29.9 Ω			500 ... 999 mΩ 1.00 ... 9.99 Ω	U _N = 120/230 V f _N = 50/60 Hz	±(18% rdg.+30d) ±(10% rdg.+3d)	±(6% rdg.+50d) ±(4% rdg.+3d)					
	I _K (Z _{L-PE})	0.0 ... 9.9 A 10 ... 999 A	0.1 A 1 A 10 A		120 (108 ... 132) V 230 (196 ... 253) V 400 (340 ... 440) V 500 (450 ... 550) V			Value calculated from Z _{L-PE}		●	●	Z _{L-PE}	
	Z _{L-PE} (AC) + DC	10.0 ... 99.9 Ω 100 ... 999 Ω	0.1 Ω 1 Ω		Display range only			±(10% rdg.+10d) ±(8% rdg.+2d)	±(2% rdg.+2d) ±(1% rdg.+1d)				
	Z _{L-PE} (15 mA)	10.0 ... 99.9 Ω 100 ... 999 Ω	0.1 Ω 1 Ω	15 mA AC	10.0 ... 99.9 Ω 100 ... 999 Ω	U _N = 120/230 V f _N = 16⅔/50/60 Hz	Value calculated from Z _{L-PE} (15 mA): I _K = U _N / Z _{L-PE} (15 mA)						
	I _K (15 mA)	100 ... 999 mA 0.00 ... 9.99 A 10.0 ... 99.9 A	1 mA 0.01 A 0.1 A		Calculated value depends on U _N and Z _{L-PE} : I _K = U _N / 10 ... 1000 Ω								
R _E	R _E (AC)	0 ... 999 mΩ 1.00 ... 9.99 Ω 10.0 ... 99.9 Ω 100 ... 999 Ω 1 kΩ ... 9.99 kΩ	1 mΩ 0.01 Ω 0.1 Ω 1 Ω 0.01 kΩ	1.3 ... 3.7 A AC 1.3 ... 3.7 A AC 400 mA AC 40 mA AC 4 mA AC	300 ... 999 mΩ 1.00 Ω ... 9.99 Ω 10.0 Ω ... 99.9 Ω 100 Ω ... 999 Ω 1.00 kΩ ... 9.99 kΩ	U _N = 120/230 V U _N = 400 V ¹ f _N = 50/60 Hz	±(10% rdg.+30d) ±(5% rdg.+3d) ±(10% rdg.+3d) ±(10% rdg.+3d) ±(10% rdg.+3d)	±(5% rdg.+30d) ±(3% rdg.+3d) ±(3% rdg.+3d) ±(3% rdg.+3d) ±(3% rdg.+3d)					
	R _E DC+	0 ... 999 mΩ 1.00 ... 9.99 Ω 10.0 ... 29.9 Ω	1 mΩ 0.01 Ω 0.1 Ω	1.3 ... 3.7 A AC 0.5/1.25 A DC	500 ... 999 mΩ 1.00 ... 9.99 Ω	U _N = 120/230 V f _N = 50/60 Hz	±(18% rdg.+30d) ±(10% rdg.+3d)	±(6% rdg.+50d) ±(4% rdg.+3d)					
	U _F	0 ... 253 V	1 V	—	Calculated value								
U _b	U _b	Limit LED on		Reb = 100 kΩ	0 ... 440 V	U _N = 120/230/400 V f _N = 50/60 Hz	45 V ±15 V	45 V ±5 V	Finger contact				
R _{INS}	R _{INS} , R _E INS	1 ... 999 kΩ 1.00 ... 9.99 MΩ 10.0 ... 49.9 MΩ	1 kΩ 10 kΩ 100 kΩ	I _K = 1.5 mA	50 kΩ ... 300 MΩ	U _N = 50 V I _N = 1 mA	k range Ω ±(6% rdg.+10d) M range Ω ±(6% rdg. + 1 d)	k Ω range ±(3% rdg.+10d) M range Ω ±(3% rdg. + 1 d)					
		1 ... 999 kΩ 1.00 ... 9.99 MΩ 10.0 ... 99.9 MΩ	1 kΩ 10 kΩ 100 kΩ			U _N = 100 V I _N = 1 mA							
		1 ... 999 kΩ 1.00 ... 9.99 MΩ 10.0 ... 99.9 MΩ 100 ... 200 MΩ	1 kΩ 10 kΩ 100 kΩ 1 MΩ			U _N = 250 V I _N = 1 mA							
		1 ... 999 kΩ 1.00 ... 9.99 MΩ 10.0 ... 99.9 MΩ 100 ... 500 MΩ	1 kΩ 10 kΩ 100 kΩ 1 MΩ			U _N = 500 V U _N = 1000 V I _N = 1 mA							
U	10 ... 999 V 1.00 ... 1.19 kV	1 V 10 V		10 ... 1.19 kV			±(3% rdg. + 1 d)	±(1.5% rdg. + 1 d)					
R _{LO}	R _{LO}	0.01 Ω ... 9.99 Ω 10.0 Ω ... 99.9 Ω 100 Ω ... 199 Ω	10 mΩ 100 mΩ 1 Ω	I _m ≥ 200 mA I _m < 200 mA	0.20 Ω ... 6.00 Ω 6.01 Ω ... 99.9 Ω	U ₀ = 4.5 V	±(5% rdg. + 2 d)	±(2% rdg. + 2 d)		●			

¹ U > 230 V with KS-PROFITEST INTRO only
² 1/2 · I_{ΔN} > 300 mA and 5 · I_{ΔN} > 500 mA and I_F > 300 mA only up to U_N ≤ 230 V!
I_{ΔN} 5 · 300 mA where U_N = 230 V only

Key: d = digits, rdg. = measured value (reading)

Reference Conditions

Line voltage	230 V ± 0.1%
Line frequency	50 Hz ± 0.1%
Meas. quantity frequency	45 Hz ... 65 Hz
Measured qty. waveform	Sine (deviation between effective and rectified value ≤ 0.1%)
Line impedance angle	cos φ = 1
Supply voltage	12 V ± 0.5 V
Ambient temperature	+22 °C ± 3 K
Relative humidity	45% ± 10%

Nominal Ranges of Use

Voltage U_N	120 V	(108 ... 132 V)
	230 V	(196 ... 253 V)
	400 V	(340 ... 440 V)
Frequency f_N	16⅔ Hz	(15.4 ... 18 Hz)
	50 Hz	(49.5 ... 50.5 Hz)
	60 Hz	(59.4 ... 60.6 Hz)
	200 Hz	(190 ... 210 Hz)
	400 Hz	(380 ... 420 Hz)
Overall voltage range U_Y	65 ... 550 V	
Overall frequency range	15.4 ... 420 Hz	
Waveform	Sinusoidal	
Temperature range	0 °C ... + 40 °C	
Supply voltage	8 ... 12 V	
Line impedance angle	Corresponds to cos φ = 1 ... 0.95	

Power Supply

(Rechargeable) batteries 8 each AA 1.5 V
We recommend using the battery pack (article number: Z502H).

Number of measurements (standard setup with illumination)

– For R_{INS} 1 measurement – 25 s pause:
approx. 600 measurements

– For R_{LO} Auto polarity reversal / 1 Ω
(1 measuring cycle) – 25 s pause:
approx. 800 measurements

Battery test Symbolic display of rechargeable battery voltage **BAT** 

Power management Display illumination can be switched off. The test instrument is switched off automatically after the last key operation. The user can select the desired on-time.

Safety shutdown If supply voltage is too low ($U < 8.0$ V), the instrument is switched off, or cannot be switched on.

Recharging socket Installed, optional rechargeable batteries can be recharged directly by connecting a charger to the recharging socket:
Z502R charger

Charging time Approx. 2 hours *

* Maximum charging time with fully depleted rechargeable batteries.
A timer in the charger limits charging time to no more than 4 hours.

Overload Capacity

U_{L-PE} , U_{L-N} 600 V continuous

RCD, R_E 440 V continuous

Z_{L-PE} , Z_{L-N} 550 V (Limits the number of measurements and pause duration. If overload occurs, the instrument is switched off by means of a thermostatic switch.)

R_{LO} Electronic protection prevents switching on if interference voltage is present.

Protection with two fine-wire fuse FF 3.15 A 10 s,
Fuses blow at > 5 A

Electrical Safety

Protection class	II per IEC 61010-1/EN 61010-1/ VDE 0411-1
Nominal voltage	230/400 V (300/500 V)
Test voltage	3.7 kV 50 Hz
Measuring category	CAT III 600 V or CAT IV 300 V
Pollution degree	2
Fuses	
L and N terminals	1 cartridge fuse-link ea. FF 3.15 A/600 V 6.3 x 32 mm

Electromagnetic Compatibility (EMC)

Product Standard EN 61326-1:2006

Interference emission		Class
EN 55022		A
Interference immunity	Test Value	Feature
EN 61000-4-2	Contact/atmos. – 4 kV/8 kV	
EN 61000-4-3	10 V/m	
EN 61000-4-4	Mains connection – 2 kV	
EN 61000-4-5	Mains connection – 1 kV	
EN 61000-4-6	Mains connection – 3 V	
EN 61000-4-11	0.5 periods / 100%	

Ambient Conditions

Accuracy	0 to + 40° C
Operation	-5 ... + 50°C
Storage	-20 ... + 60°C (without batteries)
Relative humidity	Max. 75% (max. 85% during storage/transport) no condensation allowed
Elevation	Max. 2000 m
Calibration interval	1 year (recommended)

Mechanical Design

Display	Multiple display with dot matrix, 128 x 128 pixels, backlit (transflective), dimensions: 65 x 65 mm
Dimensions	W x L x D: 225 x 130 x 140 mm
Weight	Approx. 1.5 kg with batteries
Protection	Housing: IP 52, connections: IP 40 per EN 60529/DIN VDE 0470-1

Excerpt from Table on the Meaning of IP Codes

IP XY (1 st digit X)	Protection Against Foreign Object Ingress	IP XY (2 nd digit Y)	Protection Against Penetration by Water
4	≥ 1.0 mm dia.	0	Not protected
5	Dust protected	2	Dripping (at 15° angle)

Data Interfaces

Type	USB slave for connection to a PC
Type	RS-232 for barcode and RFID readers

17.1 Technical Data for Measurement Cables and Adapters

PRO-Schuko measuring adapter (Z503K) (optional accessory)

300 V CAT III, 16 A

PRO-CH measuring adapter (Z503M) (optional accessory)

300 V CAT III, 16 A

PRO-GB measuring adapter (Z503N) (optional accessory)

300 V CAT III, 16 A

Test probe for remote triggering (Z550A) (optional accessory)

Electrical Safety

Maximum rated voltage	600 V	1000 V	1000 V
Measuring category	CAT IV	CAT III	CAT II
Maximum rated current:	1 A	1 A	16 A
With safety cap attached	•	•	—
Without safety cap	—	—	•

KS-PROFiTEST INTRO (Z503L) (scope of delivery)

Measurement cables (black, blue, yellow-green) with test probe and safety caps and alligator clips for 1000 V CAT III

Electrical Safety, Measurement Cables

Maximum rated voltage	300 V	600 V	1000 V
Measuring category	CAT IV	CAT III	CAT II
Maximum rated current:	1 A	1 A	16 A
With safety cap attached	•	•	—
Without safety cap	—	—	•

Ambient Conditions (EN 61010-031)

Temperature	-20 °C ... + 50 °C
Relative humidity	Max. 80%
Pollution degree	2

Application



Attention!

Observe the instrument's maximum values for electrical safety. Measurements per DIN EN 61010-031 may only be performed in environments in accordance with measuring categories III and IV with the safety cap attached to the test probe at the end of the measurement cable.

In order to establish contact inside 4 mm jacks, the safety caps have to be removed by prying open the snap fastener with a pointed object (e.g. the other test probe).

18 Maintenance

18.1 Firmware Revision and Calibration Information

See section 4.5.

18.2 Rechargeable Battery Operation and Charging

Check to make sure that no leakage has occurred at the rechargeable batteries at short, regular intervals, or after the instrument has been in storage for a lengthy period of time.



Note

We recommend removing the rechargeable batteries during lengthy periods of non-use (e.g. vacation). This prevents excessive depletion or leakage, which may result in damage to the instrument under unfavorable conditions.

If rechargeable battery voltage has fallen below the allowable lower limit, the pictograph shown at the right appears. "Low Batt!!!" is also displayed along with a rechargeable battery symbol. The instrument does not function if the batteries have been depleted excessively, and no display appears.



Attention!

Use only the Z502R charger in order to recharge the **Compact Master Battery Pack (Z502H)** in the test instrument.

Make sure that the following conditions have been fulfilled before connecting the charger to the charging socket:

- The Compact Master Battery Pack (Z502H) has been inserted, i.e. not a commercially available rechargeable battery pack, individual batteries or non-rechargeable batteries
- The test instrument has been disconnected from the measuring circuit at all poles
- The instrument must remain off during charging.

If the rechargeable batteries or battery pack (Z502H) have not been used or recharged for a lengthy period of time (> 1 month), thus resulting in excessive depletion:

Observe the charging sequence (indicated by LEDs at the charger) and initiate a second charging sequence if necessary (disconnect the charger from the mains and from the test instrument to this end, and then reconnect it).

Please note that the system clock stops in this case and must be set to the correct time after the instrument has been restarted.

18.2.1 Charging Procedure with the Z502R Charger

- Insert the correct mains plug for your country into the charger.



Attention!

Make sure that the **Compact Master Battery Pack (Z502H)** has been inserted and not a battery holder.

For charging within the instrument, use only the Compact Master Battery Pack (Z502H) with sealed cells included with the instrument or available as an accessory.

- Connect the charger to the test instrument with the jack plug, and then to the 230 V mains with the interchangeable plug. (The charger is suitable for mains operation only!)



Attention!

Do not switch the test instrument on during charging. Monitoring of the charging process might otherwise be disturbed, in which case the charging times specified in the technical data can no longer be assured.

- Please refer to the operating instructions included with the charger regarding the meanings of LED displays during the charging process.
- Do not disconnect the charger from the test instrument until the green **LED** (charged/ready) lights up.

18.3 Fuses

If a fuse has blown due to overloading, a corresponding message error appears at the display panel. The instrument's voltage measuring ranges are nevertheless still functional.

Fuses– FUSE Message

These fuses are active during all measurements except for voltage measurement.



Attention!

Disconnect the instrument from the measuring circuit before opening the battery compartment lid in order to replace the fuse (refer to page 3 for location)!

Checking the Fuses

If interruption of the test current circuit is detected either before or during measurement, the "FUSE" message appears at the LCD. The message is cleared after pressing any key.

After the cause of error has been eliminated and the blown fuse has been replaced, the measurement can be performed again without an error message.



Attention!

Severe damage to the instrument may occur if incorrect fuses are used.

Only original fuses from GMC-I Messtechnik GmbH may be used (order no. 3-578-285-01 / SIBA 7012540.3.15 SI-EINSATZ FF 3.15A/600V 6.3X32).

Only original fuses assure required protection by means of suitable blowing characteristics. Short-circuiting of fuse terminals or the repair of fuses is prohibited, and is life endangering!

The instrument may be damaged if fuses with incorrect ampere ratings, breaking capacities or blowing characteristics are used!

Replacing the Fuses

- ⇨ Open the battery compartment lid by loosening the two screws.
- ⇨ Remove the blown fuse and insert a new one. A replacement fuse is included in the battery compartment.
- ⇨ Insert the new fuse.
- ⇨ Replace the battery compartment lid and retighten the screws.

18.4 Housing

No special maintenance is required for the housing. Keep outside surfaces clean. Use a slightly dampened cloth for cleaning. In particular for the protective rubber surfaces, we recommend a moist, lint-free microfiber cloth. Avoid the use of cleansers, abrasives or solvents.

Returns and Environmentally Sound Disposal

The **instrument** is a category 9 product (monitoring and control instrument) in accordance with ElektroG (German electrical and electronic device law). This device is subject to the RoHS directive. We also make reference to the fact that the current status in this regard can be accessed on the Internet at www.gossenmetrawatt.com by entering the search term WEEE.

In accordance with WEEE 2012/19/EU and ElektroG, we identify our electrical and electronic devices with the symbol in accordance with DIN EN 50419 which is shown at the right. Devices identified with this symbol may not be disposed of with the trash. Please contact our service department regarding the return of old devices (see address in section 20).



If the **batteries** or **rechargeable batteries** used in your instrument are depleted, they must be disposed of properly in accordance with valid national regulations.

Batteries may contain pollutants and heavy metals such as lead (Pb), cadmium (Cd) and mercury (Hg).

The symbol at the right indicates that batteries must not be disposed of with the trash, and must be brought to a designated collection point.



Pb Cd Hg

19 Appendix

19.1 Tables for Determining Maximum or Minimum Display Values in Consideration of Maximum Measuring Uncertainty

Table 1

$Z_{L-PE} \text{ (full wave)} / Z_{L-N}$ (Ω)		$Z_{L-PE} \text{ (+/- half-wave)}$ (Ω)	
Limit Value	Max. Display Value	Limit Value	Max. Display Value
0.10	0.07	0.10	0.05
0.15	0.11	0.15	0.10
0.20	0.16	0.20	0.14
0.5	0.20	0.5	0.18
0.30	0.5	0.30	0.22
0.35	0.30	0.35	0.27
0.40	0.34	0.40	0.31
0.45	0.39	0.45	0.35
0.50	0.43	0.50	0.39
0.60	0.51	0.60	0.48
0.70	0.60	0.70	0.56
0.80	0.70	0.80	0.65
0.90	0.79	0.90	0.73
1.00	0.88	1.00	0.82
1.50	1.40	1.50	1.33
2.00	1.87	2.00	1.79
2.50	2.35	2.50	2.24
3.00	2.82	3.00	2.70
3.50	3.30	3.50	3.15
4.00	3.78	4.00	3.60
4.50	4.25	4.50	4.06
5.00	4.73	5.00	4.51
6.00	5.68	6.00	5.42
7.00	6.63	7.00	6.33
8.00	7.59	8.00	7.24
9.00	8.54	9.00	8.15
9.99	9.48	9.99	9.05

Table 3

$R_{INS} \text{ M}\Omega$			
Limit Value	Min. Display Value	Limit Value	Min. Display Value
0.10	0.12	10.0	10.7
0.15	0.17	15.0	15.9
0.20	0.23	20.0	21.2
0.5	0.28	25.0	26.5
0.30	0.33	30.0	31.7
0.35	0.38	35.0	37.0
0.40	0.44	40.0	42.3
0.45	0.49	45.0	47.5
0.50	0.54	50.0	52.8
0.55	0.59	60.0	63.3
0.60	0.65	70.0	73.8
0.70	0.75	80.0	84.4
0.80	0.86	90.0	94.9
0.90	0.96	100	106
1.00	1.07	150	158
1.50	1.59	200	211
2.00	2.12	250	264
2.50	2.65	300	316
3.00	3.17		
3.50	3.70		
4.00	4.23		
4.50	4.75		
5.00	5.28		
6.00	6.33		
7.00	7.38		
8.00	8.44		
9.00	9.49		

Table 2

$R_E / R_{ELoop} \text{ } (\Omega)$					
Limit Value	Max. Display Value	Limit Value	Max. Display Value	Limit Value	Max. Display Value
0.10	0.07	10.0	9.49	1.00 k	906
0.15	0.11	15.0	13.6	1.50 k	1.36 k
0.20	0.16	20.0	18.1	2.00 k	1.81 k
0.5	0.20	25.0	22.7	2.50 k	2.27 k
0.30	0.5	30.0	27.2	3.00 k	2.72 k
0.35	0.30	35.0	31.7	3.50 k	3.17 k
0.40	0.34	40.0	36.3	4.00 k	3.63 k
0.45	0.39	45.0	40.8	4.50 k	4.08 k
0.50	0.43	50.0	45.4	5.00 k	4.54 k
0.60	0.51	60.0	54.5	6.00 k	5.45 k
0.70	0.60	70.0	63.6	7.00 k	6.36 k
0.80	0.70	80.0	72.7	8.00 k	7.27 k
0.90	0.79	90.0	81.7	9.00 k	8.17 k
1.00	0.88	100	90.8	9.99 k	9.08 k
1.50	1.40	150	133		
2.00	1.87	200	179		
2.50	2.35	250	224		
3.00	2.82	300	270		
3.50	3.30	350	315		
4.00	3.78	400	360		
4.50	4.25	450	406		
5.00	4.73	500	451		
6.00	5.68	600	542		
7.00	6.63	700	633		
8.00	7.59	800	724		
9.00	8.54	900	815		

Table 4

$R_{LO} \text{ } \Omega$			
Limit Value	Max. Display Value	Limit Value	Max. Display Value
0.10	0.07	10.0	9.59
0.15	0.12	15.0	14.4
0.20	0.17	20.0	19.2
0.5	0.22	25.0	24.0
0.30	0.26	30.0	28.8
0.35	0.31	35.0	33.6
0.40	0.36	40.0	38.4
0.45	0.41	45.0	43.2
0.50	0.46	50.0	48.0
0.60	0.55	60.0	57.6
0.70	0.65	70.0	67.2
0.80	0.75	80.0	76.9
0.90	0.84	90.0	86.5
1.00	0.94	99.9	96.0
1.50	1.42		
2.00	1.90		
2.50	2.38		
3.00	2.86		
3.50	3.34		
4.00	3.82		
4.50	4.30		
5.00	4.78		
6.00	5.75		
7.00	6.71		
8.00	7.67		
9.00	8.63		

Table 5

Short-Circuit Current Minimum Display Values

for determining nominal current for various fuses and breakers for systems with nominal voltage of $U_N = 230\text{ V}$

Nominal Current I_N [A]	Low Resistance Fuses per the DIN VDE 0636 series of standards Characteristic gL, gG, gM				With Circuit Breaker and Line Switch							
	Breaking Current I_A 5 s		Breaking Current I_A 0.4 s		Characteristic B/E (formerly L) Breaking Current I_A $5 \times I_N (< 0.2\text{ s}/0.4\text{ s})$		Characteristic C (formerly G, U) Breaking Current I_A $10 \times I_N (< 0.2\text{ s}/0.4\text{ s})$		Characteristic D Breaking Current I_A $20 \times I_N (< 0.2\text{ s}/0.4\text{ s})$		Characteristic K Breaking Current I_A $12 \times I_N (< 0.1\text{ s})$	
	Limit Value [A]	Min. Display [A]	Limit Value [A]	Min. Display [A]	Limit Value [A]	Min. Display [A]	Limit Value [A]	Min. Display [A]	Limit Value [A]	Min. Display [A]	Limit Value [A]	Min. Display [A]
2	9.2	10	16	17	10	11	20	21	40	42	24	25
3	14.1	15	24	25	15	16	30	32	60	64	36	38
4	19	20	32	34	20	21	40	42	80	85	48	51
6	27	28	47	50	30	32	60	64	120	128	72	76
8	37	39	65	69	40	42	80	85	160	172	96	102
10	47	50	82	87	50	53	100	106	200	216	120	128
13	56	59	98	104	65	69	130	139	260	297	156	167
16	65	69	107	114	80	85	160	172	320	369	192	207
20	85	90	145	155	100	106	200	216	400	467	240	273
25	110	117	180	194	125	134	250	285	500	578	300	345
32	150	161	265	303	160	172	320	369	640	750	384	447
35	173	186	295	339	175	188	350	405	700	825	420	492
40	190	205	310	357	200	216	400	467	800	953	480	553
50	260	297	460	529	250	285	500	578	1000	1.22 k	600	700
63	320	369	550	639	315	363	630	737	1260	1.58 k	756	896
80	440	517									960	1.16 k
100	580	675									1200	1.49 k
125	750	889									1440	1.84 k
160	930	1.12 k									1920	2.59 k

Example

Display value 90.4 A → next smaller value for circuit breaker characteristic B from table: 85 A → protective device nominal current (I_N) max. 16 A

19.2 At which values should/must an RCD actually be tripped? Requirements for Residual Current Devices (RCDs)

General Requirements

- Tripping must occur no later than upon occurrence of rated residual current (nominal differential current $I_{\Delta N}$).

and

- Maximum time to trip may not be exceeded.

Additional requirements due to influences on the tripping current range and the point in time of tripping which have to be taken into consideration:

- Residual current type or waveform:
This results in a reliable tripping current range.
- Mains type and line voltage:
This results in maximum tripping time.
- RCD variant (standard or selective):
This results in maximum tripping time.

Definitions of Requirements in the Standards

VDE 0100-600, which is included in all German standards collections for **electricians**, applies to measurements in electrical systems. It plainly states: "The effectiveness of the protective measure is substantiated when shut-down occurs no later than upon occurrence of rated differential current $I_{\Delta N}$."

As a requirement for the **measuring instrument manufacturer**, **DIN EN 61557-6 (VDE 0413-6)** unmistakably specifies:

"The measuring instrument must be capable of substantiating the fact that the residual current which trips the residual current device (RCD) is less than or equal to rated residual current."





Comment

For all electricians, this means that during scheduled testing of protective measures after system modifications or additions to the system, as well as after repairs or during the E-check conducted after measurement of touch voltage, the trip test must be conducted no later than upon reaching a value of, depending upon the RCD, 10 mA, 30 mA, 100 mA, 300 mA or 500 mA

How does the electrician react in the event that these values are exceeded? The RCD is replaced!

If it was relatively new, a complaint is submitted to the manufacturer. And in his laboratory he determines: The RCD complies with the manufacturer's standard and is OK.

A look at the VDE 0664-10/-20/-100/-200 manufacturer's standard shows us why:

Type of Residual Current	Waveform of the Residual Current	Permissible Tripping Current Range
Sinusoidal alternating current		0.5 ... 1 $I_{\Delta N}$
Pulsating direct current (positive or negative half-waves)		0.35 ... 1.4 $I_{\Delta N}$
Phase angle controlled half-wave currents Phase angle of 90° el Phase angle of 135° el		0.25 ... 1.4 $I_{\Delta N}$ 0.11 ... 1.4 $I_{\Delta N}$
Pulsating direct current superimposed with 6 mA smooth, direct residual current		Max. 1.4 $I_{\Delta N}$ + 6 mA
Smooth direct current		0.5 ... 2 $I_{\Delta N}$

Because the current waveform plays a significant role, the current waveform used by the test instrument is also important.

Set residual current type or waveform at the test instrument:

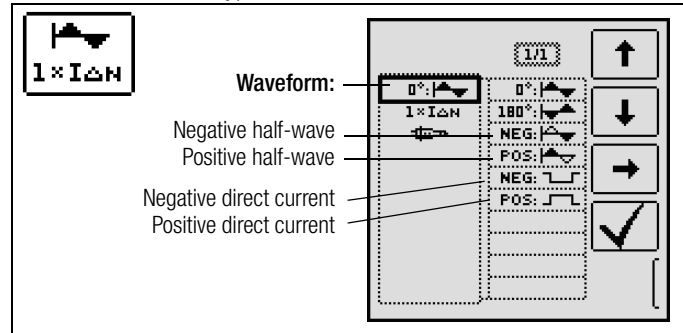

It's important to be able to select and take advantage of the corresponding settings at one's own test instrument.

The situation is similar for breaking times. The new **VDE 0100-410** should also be included in the standards collection. Depending upon mains type and line voltage, it specifies breaking times ranging from 0.1 to 5 seconds.

System	50 V < U ₀ ≤ 120 V		120 V < U ₀ ≤ 230 V		230 V < U ₀ ≤ 400 V		U ₀ > 400 V	
	AC	DC	AC	DC	AC	DC	AC	DC
TN	0.8 sec.		0.4 sec.	5 sec.	0.2 sec.	0.4 sec.	0.1 sec.	0.1 sec.
TT	0.3 sec.		0.2 sec.	0.4 sec.	0.07 sec.	0.2 sec.	0.04 sec.	0.1 sec.

RCDs usually interrupt more quickly, but in some cases they can take a bit longer. Once again, the ball is in the manufacturer's court.

The following table is also included in **VDE 0664**:

Variant	Residual Current Type	Braking Time at			
	Alternating residual current	1 x $I_{\Delta N}$	2 x $I_{\Delta N}$	5 x $I_{\Delta N}$	500 A
	Pulsating direct residual current	1.4 x $I_{\Delta N}$	2 x 1.4 x $I_{\Delta N}$	5 x 1.4 x $I_{\Delta N}$	500 A
	Smooth, direct residual current	2 x $I_{\Delta N}$	2 x 2 x $I_{\Delta N}$	5 x 2 x $I_{\Delta N}$	500 A
	Standard (undelayed) or briefly delayed	300 ms	Max. 0.15 sec.	Max. 0.04 sec.	Max. 0.04 sec.
	Selective	0.13 ... 0.5 s	0.06 ... 0.2 s	0.05 ... 0.15 s	0.04 ... 0.15 s

Two limit values are highly conspicuous:

Standard Max. 0.3 sec.

Selective Max. 0.5 sec.

All of the limit values are already included in good test instruments, or it's possible to enter them directly and they're displayed as well!

Select or set limit values at the test instrument:

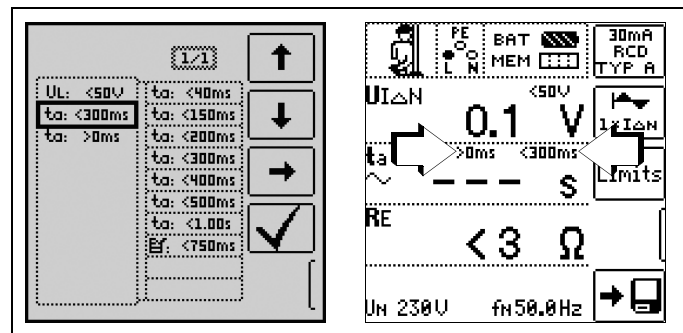

Tests for electrical systems include "visual inspection", "testing" and "measurement", and thus may only be conducted by experts with appropriate work experience.

In the final analysis, the values from VDE 0664 are technically binding.

19.3 Periodic Testing per DGUV Regulations 3 (formerly BGV A3) – Limit Values for Electrical Systems and Operating Equipment

Limit Values per DIN VDE 0701-0702

Maximum Allowable Limit Values for **Protective Conductor Resistance** for Connector Cables with Lengths of up to 5 m

Test Standard	Test Current	Open-Circuit Voltage	R _{SL} Housing – Mains Plug
VDE 0701-0702:2008	> 200 mA _{DC}	4 V < U _L < 24 V	0.3 Ω ¹ + 0.1 Ω ² for each additional 7.5 m

¹ This value may not exceed 1 Ω for permanently connected data processing systems (DIN VDE 0701-0702).

² Total protective conductor resistance: max. 1 Ω

Minimum Allowable Limit Values for Insulation Resistance

Test Standard	Test Voltage	R _{INS}			
		PC I	PC II	PC III	Heating
VDE 0701-0702:2008	500 V	1 MΩ	2 MΩ	0.25 MΩ	0.3 MΩ *

* With activated heating elements (where heating power > 3.5 kW and R_{INS} < 0.3 MΩ: leakage current measurement is required)

Maximum Permissible Limit Values for Leakage Current in mA

Test Standard	I _{PE}	I _C	I _{DI}
VDE 0701-0702:2008	PC I: 3.5 1 mA/kW *	0.5	PC I: 3.5 1 mA/ kW * PC II: 0.5

* For devices with heating power of greater than 3.5 kW

Note 1: Devices which are not equipped with accessible parts that are connected to the protective conductor, and which comply with requirements for housing leakage current and, if applicable, patient leakage current, e.g. computer equipment with shielded power pack

Note 2: Permanently connected devices with protective conductor

Note 3: Portable X-ray devices with mineral insulation

Key

I_B Housing leakage current (probe or touch current)

I_{DI} Residual current

I_{SL} Protective conductor current

Maximum Permissible Limit Values for Equivalent Leakage Current in mA

Test Standard	I _{EL}
VDE 0701-0702:2008	PC I: 3.5 1 mA/kW ¹ PC II: 0.5

¹ For devices with heating power ≥ 3.5 kW

19.4 Optional Accessories (not included)

Master Battery Pack (material no. Z502H)

8 LSD NiMH rechargeable batteries with reduced self-discharging (AA), 2000 mAh with sealed cells

Charger (material no. Z502R)

Broad-range charger for charging NiMH batteries in the measuring instrument
Input: 100 to 240 V AC, output: 16.5 V DC, 0.6 A

ISO Calibrator 1 (material no. M662A)

Calibration adapter for testing the accuracy of instruments used for measuring insulation resistance and low-resistance for test voltages of up to 1000 V (per VDE 0413, parts 1, 2, 4 and 10).

PRO-Schuko measuring adapter (material no. Z503K)

Single-phase, country-specific measuring adapter for the **PROFITEST INTRO**, earthing contact plugs to three 4 mm safety plugs (black, blue, yellow-green), 300 V CAT III, 16 A, touch-guarded

PRO-CH measuring adapter (material no. Z503M)

Single-phase, country-specific measuring adapter for the **PROFITEST INTRO**, earthing contact plugs to three 4 mm safety plugs (black, blue, yellow-green), 300 V CAT III, 16 A, touch-guarded

PRO-GB measuring adapter (material no. Z503N)

Single-phase, country-specific measuring adapter for the **PROFITEST INTRO**, earthing contact plugs to three 4 mm safety plugs (black, blue, yellow-green), 300 V CAT III, 16 A, touch-guarded

PRO-JUMPER (material no. Z503J)

Touch-guarded short-circuit adapter for the **PROFITEST INTRO** for measurement cable compensation

PRO-JUMPER-CH (material no. Z503P)

Touch-guarded short-circuit adapter for the **PROFITEST INTRO** for measurement cable compensation

PRO-JUMPER-GB (material no. Z503R)

Touch-guarded short-circuit adapter for the **PROFITEST INTRO** for measurement cable compensation

1081 Probe (material no. GTZ3196000R0001)

Triangular probe for floor measurements per EN 1081, DIN VDE 0100-600 (R_{E(INS)})

Test probe for remote triggering (material no. Z550A)

Optional plug-on measurement cable with a triggering key on the test probe and an additional key for illuminating the measuring point, including shielded, plug-in connector cable

RS-232 Profiscanner for barcodes (material no. Z502F)

Barcode scanner for RS 232 connection (laser sensor), variable barcode length, enhanced reading accuracy, with coil cable

SCANBASE RFID (material no. Z751G)

RFID read/write for RS 232 port (13.56 MHz)

VARIO Plug Adapter Set (material no. Z500A)

Probe set (material no. Z503F)

Set of test probes (red/black)
CAT III 600 V, 1 A, test probe working range: 68 mm – diameter: 2.3 mm

TR25 reel (material no. GTZ3303000R0001)

Reel with 25 m measurement cable

TR50 drum (material no. GTY1040014E34)

Drum with 50 m measurement cable

PRO-PE clip (material no. Z503G)

Flat test clip for contacting busbars quickly and safely. Good contact at the front and back of the busbar thanks to time-tested contact blades. Rigid 4 mm socket in the handle, suitable for the insertion of spring-loaded 4 mm plugs with rigid insulating sleeve, 1000 V CAT IV/32 A.

Further accessories and additional information concerning accessories can be found in the data sheet for the **PROFITEST INTRO**.

19.5 List of Abbreviations and their Meanings

RCCB (residual current circuit breaker)

I_{Δ}	Tripping current
$I_{\Delta N}$	Nominal residual current
$I_{F\blacktriangleleft}$	Rising test current (residual current)
PRCD	Portable residual current device
PRCD-S:	with protective conductor detection and monitoring
PRCD-K:	with undervoltage trigger and protective conductor monitoring
RCD-S	Selective RCCB
R_E	Calculated earthing or earth electrode loop resistance
SRCD	Socket residual current device (permanently installed)
t_a	Time to trip / breaking time
$U_{I\Delta}$	Touch voltage at moment of tripping
$U_{I\Delta N}$	Touch voltage relative to nominal residual current $I_{\Delta N}$
U_L	Touch voltage limit value

Overcurrent Protective Devices

I_K	Calculated short-circuit current (at nominal voltage)
Z_{L-N}	Line impedance
Z_{L-PE}	Loop impedance

Earthing

R_B	Operational earth resistance
R_E	Measured earthing resistance
$R_{E\text{Loop}}$	Earth electrode loop resistance

Low-Value Resistance at Protective, Earthing and Bonding Conductors

R_{LO+}	Bonding conductor resistance (+ pole to PE)
R_{LO-}	Bonding conductor resistance (- pole to PE)

Insulation

$R_{E(\text{INS})}$	Earth leakage resistance (DIN 51953)
R_{INS}	Insulation resistance

Current

I_A	Breaking current
I_M	Measuring current
I_N	Nominal current
I_P	Test current

Voltage

f	Line voltage frequency
f_N	Nominal voltage rated frequency
ΔU	Voltage drop as %
U	Voltage measured at the test probes during and after insulation measurement R_{INS}
U_{Batt}	(Rechargeable) battery voltage
U_E	Earth electrode voltage
U_{INS}	For measurement of R_{INS} : test voltage, for ramp function: triggering or breakdown voltage
U_{L-L}	Voltage between two phase conductors
U_{L-N}	Voltage between L and N
U_{L-PE}	Voltage between L and PE
U_N	Nominal line voltage
$U_{3\sim}$	Highest measured voltage during determination of phase sequence
U_Y	Phase voltage to earth

19.6 Keyword Index

A		ÖVE-EN 1	6
Abbreviations	58	VDE 0413	25
Adjusting Brightness and Contrast	11	Symbols	7
B		T	
Batteries		Testing	
Charge Level	4	DGUV Regulation 3	57
Installation	8	Touch Voltage	19
Bibliography	60	Type G RCCBs	24
D		U	
Data Backup	7	User Interface Language (CULTURE)	11
DB MODE	11	V	
Default Settings (GOME SETTING)	11	Voltage Drop as % (ZL-N function)	37
E		Voltage Drop Measurement	37
Earth Leakage Resistance	34		
F			
Firmware Revision and Calibration Information	12		
Firmware Update	12		
Fuse			
Checking	53		
FUSE Message	53		
Replacement	53		
I			
Internet Addresses	60		
L			
Limit Values			
DINVDE0701-0702	57		
Line Voltage (display of UL-N)	28		
Line-to-Line Voltage	17		
M			
MASTER Updater	12		
Memory			
Occupancy Display	4		
N			
No-Trip Test	21		
O			
On-Time			
LCD Illumination	11		
Test Instrument	11		
P			
Parameter Lock	14		
Phase Sequence	17		
Plausibility Check	14		
Polarity Reversal	15		
Power Management	13, 51		
PRCD			
Tripping Test, Type PRCD-K	22		
Tripping Test, Type PRCD-S	23		
Profiles for Distributor Structures (PROFILES)	11		
R			
RCD-S	22		
Return and Environmentally Sound Disposal	53		
S			
Safety Shutdown	13, 44, 51		
SCHUKOMAT	23		
Short-Circuit Current Calculation	27		
SIDOS	23		
SRCD	23		
Standard			
DIN EN 50178 (VDE 160)	21		
DIN VDE 0100	25, 30		
DIN VDE 0100-410	22		
DIN VDE 0100-600	6, 20, 26		
EN 1081	34		
NIV/NIN SEV 1000	6		
ÖVE/ÖNORM E 8601	24		

19.7 Bibliography

Statutory Source Documents			
German occupational safety legislation (BetrSichV) Regulations issued by the accident insurance carriers			
Title	Information Rule / Regulation	Publisher	Issue / Order no.
German occupational safety legislation (BetrSichV)	German occupational safety legislation		2015
Electrical systems and equipment	DGUV regulation 3 (formerly BGV A3)	DGUV (formerly HVBG)	2014

VDE Standards			
German standard	Title	Date of Issue	Publisher
DIN VDE 0100-410	Protection against electric shock	2007-06	Beuth-Verlag GmbH
DIN VDE 0100-530	Low-voltage electrical installations Part 530: Selection and erection of electrical equipment – Switchgear and controlgear	2011-06	Beuth-Verlag GmbH
DIN VDE 0100-600	Low-voltage electrical installations Part 6: Tests	2008-06	Beuth-Verlag GmbH
Series of standards DIN EN 61557	Devices for testing, measuring or monitoring protective measures	2006-08	Beuth-Verlag GmbH
DIN VDE 0105-100	Operation of electrical installations, part 100: General requirements	2009-10	Beuth-Verlag GmbH
VDE 0122-1 DIN EN 61851-1	Electric vehicle conductive charging system – Part 1: General requirements	2013-04	Beuth-Verlag GmbH

Further Literature in German			
Title	Author	Publisher	Issue / Order no.
Prüfung ortsfester und ortsveränderlicher Geräte	Bödeker, W. Lochthofen, M.	HUSS-MEDIEN GmbH Berlin www.elektropraktiker.de	8 th edition, 2014 ISBN 978-3-341-01614-5
Wiederholungsprüfungen nach DIN VDE 105	Bödeker, K.; Lochthofen, M.; Roholf, K.	Hüthig & Pflaum Verlag www.vde-verlag.de	3 rd edition, 2014 VDE order no. 310589
Prüfungen vor Inbetriebnahme von Niederspannungsanlagen DIN VDE 0100-600	Kammler, M.	VDE Verlag GmbH www.vde-verlag.de	VDE series, volume 63, 4 th edition, 2012
Schutz gegen elektr. Schlag DIN VDE 0100-410	Hörmann, W. Schröder, B.	VDE Verlag GmbH www.vde-verlag.de	VDE series, volume 140, 4 th edition, 2010
VDE-Prüfung nach BetrSichV, TRBS und BGV A3	Henning, W.	Beuth-Verlag GmbH www.beuth.de	VDE series 43 2012 edition
Merkbuch für den Elektrofachmann	GMC-I Messtechnik GmbH	www.gossenmetrawatt.com	Order no. 3-337-038-01
de Jahrbuch 2014 Elektrotechnik für Handwerk und Industrie	Behrends, P.; Bonhagen, S.	Hüthig & Pflaum Verlag München/Heidelberg www.elektro.net	ISBN 978-3-8101-0350-5
Elektroinstallation für die gesamte Ausbildung	Hübscher, Jagla, Klaue, Wickert	Westermann Schulbuchverlag GmbH www.westermann.de	ISBN 978-3-14-221630-0 3 rd edition, 2009
Praxis Elektrotechnik	Bastian, Feustel, Käppel, Schuberth, Tkotz, Ziegler	Europa-Lehrmittel www.europa-lehrmittel.de	ISBN 978-3-8085-3134-1 12 th edition, 2012
Fachkunde Elektrotechnik		Europa-Lehrmittel www.europa-lehrmittel.de	ISBN 978-3-8085-3190-7, 29 th edition, 2014

19.7.1 Internet Addresses for Additional Information

Internet Address	
www.dguv.de	DGUV information, rules and regulations from German statutory accident insurance
www.beuth.de	VDE regulations, DIN standards, VDI directives from Beuth-Verlag GmbH
www.bgetem.de	BG information, rules and regulations from the trade associations, e.g. BG ETEM (trade association for energy, textiles and electrical medical devices)

20 Repair and Replacement Parts Service Calibration Center* and Rental Instrument Service

If required please contact:

GMC-I Service GmbH
Service Center
Beuthener Straße 41
D-90471 Nürnberg, Germany
Phone: +49-911-817718-0
Fax: +49-911-817718-253
e-mail: service@gossenmetrawatt.com
www.gmci-service.com

This address is only valid in Germany.
Please contact our representatives or subsidiaries for service in other countries.

* **DAkkS calibration laboratory for electrical quantities, registration no. D-K-15080-01-01, accredited per DIN EN ISO/IEC 17025**

Accredited quantities: direct voltage, direct current value, direct current resistance, alternating voltage, alternating current value, AC active power, AC apparent power, DC power, capacitance, frequency and temperature

Competent Partner

GMC-I Messtechnik GmbH is certified in accordance with DIN EN ISO 9001.

Our DAkkS calibration laboratory is accredited by the Deutsche Akkreditierungsstelle GmbH (national accreditation body for the Federal Republic of Germany) under registration number D-K-15080-01-01 in accordance with DIN EN ISO/IEC 17025.

We offer a complete range of expertise in the field of metrology: from **test reports** and **factory calibration certificates** right on up to **DAkkS calibration certificates**.

Our spectrum of offerings is rounded out with free **test equipment management**.

An **on-site DAkkS calibration station** is an integral part of our service department. If errors are discovered during calibration, our specialized personnel are capable of completing repairs using original replacement parts.

As a full service calibration laboratory, we can calibrate instruments from other manufacturers as well.

21 Recalibration

The measuring tasks performed with your instrument, and the stressing it's subjected to, influence aging of its components and may result in deviation from the specified levels of accuracy.

In the case of strict measuring accuracy requirements, as well as in the event of use at construction sites with frequent stress due to transport and considerable temperature fluctuation, we recommend a relatively short calibration interval of once per year. If your instrument is used primarily in the laboratory and indoors without considerable climatic or mechanical stressing, a calibration interval of once every 2 to 3 years is sufficient as a rule.

During recalibration at an accredited calibration laboratory (DIN EN ISO/IEC 17025), deviations from traceable standards demonstrated by your measuring instrument are documented. Ascertained deviations are used to correct display values during later use of the instrument.

We would be happy to perform DAkkS or factory calibration for you at our calibration laboratory. Further information is available at our website:

www.gossenmetrawatt.com (→ Company → DAkkS Calibration Center or → FAQs → Questions and Answers Regarding Calibration).

Recalibration of your instrument at regular intervals is essential for the fulfillment of requirements according to quality management systems per DIN EN ISO 9001.

* Examination of the specification, as well as adjustment, are not included in calibration. However, in the case of our own products, any required adjustment is performed and adherence to the specification is confirmed.

22 Product Support

If required please contact:

GMC-I Messtechnik GmbH
Product Support Hotline
Phone: +49-911-8602-0
Fax: +49 911 8602-709
e-mail: support@gossenmetrawatt.com

Prepared in Germany • Subject to change without notice • PDF version available on the Internet

 **GOSSEN METRAWATT**

GMC-I Messtechnik GmbH
Südwestpark 15
D-90449 Nürnberg, Germany

Phone: +49-911-8602-111
Fax: +49 911 8602-777
e-mail info@gossenmetrawatt.com
www.gossenmetrawatt.com