

METRAHIT PM PRIME & METRAHIT PM PRIME BT

Professional Multimeters / High Resolution TRMS Digital Multimeters

3-349-684-03
17/7.23



Scope of Delivery

Scope of Delivery

- 1 Multimeter
- 1 KS17-2 measurement cable set
- 2 Batteries 1.5 V, type AA
- 1 DAkkS calibration certificate
- 1 Rubber holster
- 1 Condensed operating instructions *

* Detailed operating instructions are available for download on the Internet at www.gossenmetrawatt.com

Included Functions

Function	METRAHIT PM PRIME (M248A) METRAHIT PM PRIME BT (M248B)
Voltage, V_{DC} ($R_i = 10 \text{ M}\Omega$)	✓
Voltage, V_{AC} TRMS ($R_i = 5 \text{ M}\Omega$)	✓
Voltage, V_{AC+DC} TRMS ($R_i \geq 5 \text{ M}\Omega$)	up to 300 kHz
Frequency, Hz @ V_{AC} @ V_{AC+DC}	@ V_{AC} @ V_{AC+DC}
1 kHz low-pass filter	100 kHz
Bandwidth @ V_{AC+DC} or V_{AC}	1 Hz to 1 MHz
Pulse frequency, MHz @ 5 V TTL	2,0 % to 98 %
Duty cycle as %	@ V_{AC} @ V_{AC+DC}
Voltage level measurement, dB	✓
Resistance, Ω	✓
Continuity test, ICONST = 1 mA	✓
Diode test, $I_{CONST} = 1 \text{ mA}$	Typ K
Temp. measurement °C/°F @ T_C	Pt100/Pt1000
Temp. measurement °C/°F R_{TD}	✓

Function	METRAHIT PM PRIME (M248A) METRAHIT PM PRIME BT (M248B)
Capacitance measurement, F	300 mA/3 mA
Current, A_{DC}	30 mA/300 mA
Current, A_{AC+DC} TRMS	3 A / 10 A (16 A)
Current, A_{AC} TRMS	10 kHz
Bandwidth @ A_{AC+DC} or A_{AC}	up to 30 kHz
Frequency, Hz @ A_{AC} @ V_{AC+DC}	∞ mV / A ∞ mA / A
Current clamp measurement with adjustable transformation ratio	16 MBit (2 MB)
Data logger function ¹ (memory)	✓
Relative value measurement Δ REL	✓
Zero point	✓
Min / Max / Data Hold	✓
IR interface (38.4 kBd)	METRAHIT PM PRIME BT only (M248B)
Bluetooth interface (38.4 kBd)	✓
Power pack socket	✓
Rubber holster	10 A / 1000 V
Fuse	IP52
Protection	600 V CAT III 300 V CAT IV
Measuring category	✓
DAkkS Calibration Certificate	METRAHIT PM PRIME (M248A) METRAHIT PM PRIME BT (M248B)

¹ 16 Mbit = 2048 kByte = 300,000 measured values, sampling rate adjustable from 0.1 seconds to 9 hours

Accessories (sensors, plug inserts, adapters, consumable materials)

The accessories available for your instrument are checked for compliance with currently valid safety regulations at regular intervals, and are amended as required for new applications. Currently up-to-date accessories which are suitable for your measuring instrument are listed at the following web address along with photo, order number, description and, depending upon the scope of the respective accessory, data sheet and operating instructions: www.gossenmetrawatt.com

See also section 14 on page 70.

Contact, Support and Service

Gossen Metrawatt GmbH can be reached directly and simply – we have a single number for everything! Whether you require support or training, or have an individual inquiry, we can answer all of your questions here:

+49-911-8602-0

Monday to Thursday: 8 a.m. to 4 p.m.
Friday: 8 a.m. to 2 p.m.

Or contact us by e-mail at:
info@gossenmetrawatt.com

Do you prefer support by e-mail?

Measuring and Test Technology: support@gossenmetrawatt.com

Industrial Measuring Technology: support.industrie@gossenmetrawatt.com

Enquiries concerning training and seminars can also be submitted by e-mail and online:

training@gossenmetrawatt.com

<https://www.gossenmetrawatt.com/training>



Scope of Delivery

Please contact GMC-I Service GmbH for repairs, replacement parts and calibration¹⁾:

+49-911-817718-0

service@gossenmetrawatt.com

www.gmci-service.com

Beuthener Str. 41

90471 Nürnberg

Germany



Software Enabling for METRAWin10

Please contact us directly (see page 3).

¹⁾ DAkkS calibration laboratory per DIN EN ISO/IEC 17025 – accredited by the Deutsche Akkreditierungsstelle GmbH under reference number D-K-15080-01-01.

Content	Page	Content	Page
1 Safety Instructions	7	6.5 Measurement Data Recording	24
2 Application	10	6.5.1 Long-Term Recording	24
2.1 Intended Use / Use for Intended Purpose	10	6.5.2 Storage of Individual Values using the SAMPLE or dAtA Sampling Rate	26
2.2 Use for Other than Intended Purpose	10	7 Measurements	27
2.3 Liability and Guarantee	10	7.1 Voltage Measurement	27
3 Documentation	11	7.1.1 Direct and Pulsating Voltage Measurement, V DC and V (DC+AC)	28
3.1 Meanings of Danger Symbols	11	7.1.2 Alternating Voltage and Frequency Measurement V AC and Hz V AC with Selectable Low-Pass Filter, V AC + FiL and dB V AC	30
3.2 Meanings of Acoustic Warning Signals	11	7.1.3 Frequency and Duty Cycle Measurement	33
4 Operating Overview – Connections, Keys, Rotary Switch, Symbols	12	7.2 Resistance Measurement Ω	34
5 Initial Start-Up	16	7.3 Continuity Test with Constant Current of 1 mA	35
5.1 Establishing Electrical Power Supply	16	7.4 Diode Testing with Constant Current of 1 mA	36
5.2 Switching the Instrument On	16	7.5 Temperature Measurement	37
5.3 Setting the Operating Parameters	17	7.5.1 Measurement with Thermocouples, Temp TC	37
5.4 Switching the Instrument Off	17	7.5.2 Measurement with Resistance Sensors	38
6 Control Functions	19	7.6 Capacitance Measurement	39
6.1 Selecting Measuring Functions and Measuring Ranges	19	7.7 Current Measurement	40
6.1.1 Automatic Range Selection	19	7.7.1 Direct and Pulsating Current Measurement, Direct Connection, A DC and A (DC+AC)	41
6.1.2 Manual Measuring Range Selection	20	7.7.2 Alternating Current and Frequency Measurement, Direct Connection, A AC and Hz	42
6.1.3 Quick Measurements	20	7.7.3 Direct and Pulsating Current Measurement with Current Clamp Sensor, A DC and A (DC+AC)	43
6.2 Zero Offset / Relative Measurements	20	7.7.4 Alternating Current Measurement with Current Clamp Sensor, A AC and Hz	44
6.3 Display (LCD)	21	7.7.5 Alternating Current Measurement with Current Clamp Transformer, A AC and Hz	45
6.4 Measured Value Storage: DATA (auto-hold / compare)	22		
6.4.1 Saving Minimum and Maximum Values – Min/Max Function	23		

Table of Contents

Content	Page	Content	Page
8 Device and Measuring Parameters	46	14 Accessories	70
8.1 Paths to the Various Parameters	47	14.1 General	70
8.2 List of All Parameters	47	14.2 Technical Data for Measurement Cables (scope of delivery: KS17-2 safety cable set)	70
8.3 Querying Parameters – InFo Menu	48	14.3 NA X-TRA Power Pack (not included)	70
8.4 Entering Parameters – SETUP Menu	49	14.4 Interface Accessories (not included)	71
8.5 StorE Menu – Parameter for Memory Mode Operation	51		
8.6 Default Settings	53		
9 Interface Operation	54	15 CE Declaration	73
9.1 Arten von Schnittstellen und Anwendungszwecke	54		
9.2 Activating the Interface	54		
9.3 Configuring Interface Parameters	55		
10 Technical Data	57		
11 Maintenance and Calibration	64		
11.1 Displays – Error Messages	64		
11.2 Batteries	64		
11.3 Fuse	65		
11.4 Cleaning	66		
11.5 Recalibration	66		
12 Repair	67		
13 Disposal and Environmental Protection	68		

1 Safety Instructions

- Read and follow these instructions carefully and completely in order to ensure safe and proper use.
- The instructions must be made available to all persons who use the instrument.
- Keep for future reference.

General

- Tests/measurements may only be executed by a qualified electrician.
- Observe and comply with all safety regulations which are applicable for your work environment.
- Wear suitable and appropriate personal protective equipment (PPE) whenever working with the instrument.

Accessories

- We recommend only using the specified accessories (included in the scope of delivery or listed as options) with the instrument.
If you use other accessories, Gossen Metrawatt assumes no liability for property damage, personal injury or consequential damage. Furthermore, no support will be provided.
- Carefully and completely read and adhere to the product documentation for optional accessories. Retain these documents for future reference.

Handling

- Use the instrument in undamaged condition only.
Inspect the instrument before use. Pay particular attention to damage, interrupted insulation or kinked cables.
- Use the accessories and all cables in undamaged condition only.

Inspect accessories and all cables before use. Pay particular attention to damage, interrupted insulation or kinked cables.

- If the instrument or its accessories don't function flawlessly, permanently remove the instrument/accessories from operation and secure them against inadvertent use.
- If the instrument or accessories are damaged during use, for example if they're dropped, permanently remove the instrument/accessories from operation and secure them against inadvertent use.
- If there are any signs of interior damage to the instrument or accessories (e.g. Loose parts in the housing), permanently remove the instrument/accessories from operation and secure them against inadvertent use.
- The tester and the accessories may only be used for the tests/measurements described in the documentation for the tester.
- Observe and abide by visual and acoustic warning signals!
- The multimeter may only be operated by persons who are capable of recognizing touch hazards and taking the appropriate safety precautions.
Touch hazards in accordance with the standard exist anywhere, where voltages of greater than 33 V (RMS) or 70 V DC may occur. Avoid working alone when taking measurements which involve touch hazards. Be certain that a second person is present.
- The instrument is equipped with an automatic socket blocking mechanism. This mechanism is linked to the rotary switch and only allows access to those jacks which are actually required for the selected function. It also prevents the user from turning

the rotary switch to impermissible functions after the measurement cables have already been plugged in.

Do not bypass the automatic socket blocking mechanism.

- Maximum permissible voltage between the voltage measuring sockets or all connector sockets and ground is 600 V for measuring category III and 300 V for measuring category IV.
- Be prepared for the occurrence of unexpected voltages at devices under test (e.g. defective devices). For example, capacitors may be dangerously charged.
- Hazardous touch voltages are not detected when the ohm or capacitance measurement is selected.
- If the instrument switches itself off in the event that hazardous touch voltage is applied (only possible during memory mode operation), the high-voltage warning symbol remains visible at the display.
- Do not perform any measurements in electrical circuits with corona discharge (high voltage).
- Dangerous pulsating voltages in HF electrical circuits! Use caution when performing measurements there.
- Dangerous voltage peaks with significant frequency components of greater than 1 kHz are not displayed when the low-pass filter is activated.
Measure voltage without the low-pass filter first, in order to be able to detect any dangerous voltages.
- If dangerous voltages are applied in the high-impedance voltage measuring functions (switch position V), switching to low-impedance measuring functions (switch position Ω , continuity, temperature or capacitance) causes "HiVoLt" to appear at the display and the respective measurement is disabled.

Operating Conditions

- Do not use the instrument and its accessories after long periods of storage under unfavorable conditions (e.g. humidity, dust or extreme temperature).
- Do not use the instrument and its accessories after extraordinary stressing due to transport.
- Do not expose the instrument to direct sunlight.
- Only use the instrument and its accessories within the limits of the specified technical data and conditions (ambient conditions, IP protection code, measuring category etc.). In particular, do not overload the measuring ranges beyond their allowable capacities.
- Do not use the instrument in potentially explosive atmospheres. Danger of explosion!

Measurement Cables and Establishing Contact

- Plugging in the measurement cables must not necessitate any undue force.
- Never touch conductive ends (for example of test probes).
- Fully unroll all measurement cables before starting a test/measurement. Never perform a test/measurement with the measurement cable rolled up.
- Avoid short circuits due to incorrectly connected measurement cables.
- The measuring instrument, including measurement cables and plug-on test probes, may only be utilized up to the maximum specified measuring category.
If the measuring categories specified for the measuring instrument and the measurement cables differ from each other, the lower category applies.

- Ensure that alligator clips, test probes, etc. make good contact.
- Do not move or remove test probes, alligator clips, etc. until testing/measurement has been completed.

Rechargeable or regular batteries

- The multimeter may only be operated with installed batteries or rechargeable batteries. Dangerous currents and voltages are otherwise not indicated, and the instrument may be damaged.
- Use batteries in undamaged condition only. Risk of explosion and fire in the case of damaged batteries!
Inspect the batteries before use. Pay particular attention to leaky and damaged batteries.
- Use the instrument only with the battery compartment lid inserted and properly closed.
Touch contact with dangerous voltage is otherwise possible.

Fuses

- The instrument may only be used as long as the fuses are in flawless condition. Defective fuses must be replaced. Fuses may only be replaced by our repair service department.
- Never bridge the fuses. Never put the fuses out of operation.
- Use the instrument only with the fuse compartment cover inserted and properly closed.
Touch contact with dangerous voltage is otherwise possible.

2 Application

Please read this important information!

2.1 Intended Use / Use for Intended Purpose

The instruments METRAHIT PM PRIME¹⁾ and METRAHIT PM PRIME BT²⁾ are high resolution TRMS digital multimeters for professional use. All three are portable instruments which can be held in the hand while performing measurements. They can be used to perform the measurements described in these operating instructions.

Performance characteristics of the individual models: See „Scope of Delivery“ on page 2.

The multimeter is equipped with an automatic socket blocking mechanism for your safety, and in order to safeguard your instrument. This mechanism is linked to the rotary switch and only allows access to those jacks which are actually required for the selected function. It also prevents the user from turning the rotary switch to impermissible functions after the measurement cables have already been plugged in.

Safety of the user, as well as that of the instrument, is only assured when it's used for its intended purpose.

2.2 Use for Other than Intended Purpose

Using the instrument for any purposes other than those described in the condensed operating instructions or these instrument operating instructions is contrary to use for intended purpose.

2.3 Liability and Guarantee

Gossen Metrawatt GmbH assumes no liability for property damage, personal injury or consequential damage resulting from improper or incorrect use of the product, in particular due to failure to observe the product documentation. The same applies to maintenance measures which are not executed properly or in due time. Furthermore, all guarantee claims are rendered null and void in such cases.

Nor does Gossen Metrawatt GmbH assume any liability for data loss.

¹⁾ Formerly METRAHIT ULTRA.

²⁾ Formerly METRAHIT ULTRA BT.

3 Documentation

The following symbols with the meanings listed below are used in this documentation.

3.1 Meanings of Danger Symbols



Warning concerning a point of danger
(attention, observe documentation!)





Symbol on the LCD:
Warning concerning dangerous voltage at the measurement input:
 $U > 45 \text{ V}$







Hinweis

The auto power off function (**APoFF** parameter) is deactivated when dangerous touch voltage is applied.

3.2 Meanings of Acoustic Warning Signals

  **High-voltage warning: > 600 V (intermittent acoustic signal)**

  **Heavy current warning: > 10 A (intermittent acoustic signal)**

  **Heavy current warning: > 16 A (continuous acoustic signal)**

4 Operating Overview – Connections, Keys, Rotary Switch, Symbols





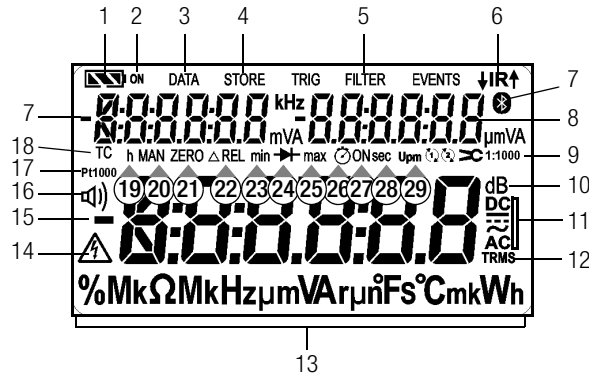

- 1 Display (LCD) (see page 14 for significance of symbols)
- 2 **MAN / AUTO** shift key for manual/automatic range selection
 △ Increase parameter values
Operating mode menu: select menu entries against flow direction
- 3 **ON / OFF | LIGHT**, on/off key for switching device and display light
- 4 **FUNC | ENTER** multifunction key
Operating mode menu: acknowledge entry (ENTER)
- 5 ▷ Increase measuring range or move decimal point to right (MAN function)
- 6 **Rotary switch** for measuring functions, (see page 15 for significance of symbols)
- 7 DAKkS calibration seal
- 8 Connector socket for ground / connected to ground
- 9 Connector socket for current measurement with auto-blocking
- 10 Connector socket for voltage, resistance, temperature, diode and capacitance measurement with automatic blocking
- 11 **DATA/MIN/MAX**
 Key for freezing, comparing and deleting the measured value, and for the Min-Max function
 ▽ Decrease values
Operating mode menu: select of menu entries in flow direction
- 12 **MEASURE | SETUP**
 Key for switching between measuring and menu functions
- 13 **ZERO | ESC**
 Key for zero balancing
Operating mode menu: Exit current menu level and return to a higher level, exit parameters configuration without saving data
- 14 ◁ Decrease measuring range or move decimal to left (MAN function)
- 15 Power pack connector jack
- 16 Infrared interface



Symbols Used in the Digital Display





Battery Level Indicator

-  Battery full
-  Battery OK
-  Battery weak
-  Battery (almost) dead, $U < 2.0\text{ V}$

Interface Indicator

-  Data transmission ↓ to / ↑ from multimeter active
-  IR interface in standby mode (ready to receive starting commands)

- 1 Battery level indicator
- 2 ON: continuous operation (automatic shutdown deactivated)
- 3 DATA: display memory, “freeze measured value”
- 4 STORE: memory mode active
- 5 FILTER: low-pass filter active
- 6 IR: infrared interface indicator
- 7 Bluetooth interface control display
- 8 **Auxiliary display:** digital display with decimal point and polarity display
- 9 Transformation ratio (factor for current sensor and transformer clamps)
- 10 dB: alternating voltage level measurement
- 11 Selected type of current
- 12 TRMS measurement
- 13 Unit of Measure
- 14 **Warning regarding dangerous voltage: $U > 45\text{ V AC/DC}$**
- 15 **Main display:** digital display with decimal point and polarity display
- 16  Continuity test with acoustic signal active
- 17 Pt100/Pt1000: selected platinum resistance sensor with automatic recognition of Pt100/Pt1000
- 18 TC: temperature measurement with type K thermocouple (NiCr-Ni)
- 19 h (hours): unit of time
- 20 MAN: manual measuring range selection active
- 21 ZERO: zero balancing active
- 22 ΔREL: relative measurement with reference to offset
- 23 min: minimum value storage
- 24 Diode measurement selected
- 25 max: maximum value storage
- 26  Stopwatch active or time since beginning of measurement
- 27 ON: no function here
- 28 sec (seconds): unit of time
- 29 Upm : no function here



Symbols Used for Rotary Switch Positions

Switch	FUNC	Main Display	Auxiliary Display	Measuring Function
V~	0/4	V~ AC TRMS	Hz	Alternating voltage, AC TRMS, full bandwidth / voltage frequency
Hz (V)	1	Hz	V~ AC	Voltage frequency, up to 300 kHz / alternating voltage, AC TRMS
V~ $\overline{1\text{kHz}}$	2	V FILTER ~ AC TRMS	Hz	Alternating voltage, AC TRMS, with low pass filter (1 kHz) / voltage frequency
dB	3	dB	V~ AC TRMS	Alternating voltage level measurement
V $\overline{\sim}$	0/4	V $\overline{\sim}$ DC + AC TRMS	Hz	Pulsating voltage, TRMS ($V_{AC+DC} = \sqrt{V_{AC}^2 + V_{DC}^2}$) / voltage frequency
V $\overline{\sim}$	1	Hz	V $\overline{\sim}$ DC + AC TRMS	Voltage frequency / pulsating voltage, TRMS
V $\overline{\sim}$	2	V $\overline{\sim}$ FILTER DC + AC TRMS	Hz	Pulsating voltage, TRMS with low pass filter (1 kHz) / voltage frequency
dB	3	dB	V $\overline{\sim}$ DC + AC TRMS	Alternating voltage level measurement
V $\overline{=}$	0/2	V $\overline{=}$ DC	—	Direct voltage
MHz	0/2	MHz	—	(High) frequency at 5 V~ up to 1 MHz
%	1	%	Hz	Duty cycle / frequency
Ω	—	Ω	—	(DC) resistance
$\square(\downarrow)$	0/2	$\square(\downarrow)$ Ω	—	Continuity test (Ω) with acoustic signal
$\rightarrow $	1	$\rightarrow $ V $\overline{=}$ DC	—	Diode voltage up to max. 4.5 V
Temp. TC	0/2	°C, type K	°C internal temp. at jacks	Temperature, type K thermocouple
Temp. RTD	1	°X, Pt100		Temperature with Pt100 / Pt1000 resistance sensor
\dashv	—	nF	—	Capacitance
A $\overline{=}$	0/3	A $\overline{=}$ DC	—	Direct current value
A $\overline{\sim}$	1	A $\overline{\sim}$ DC + AC TRMS	Hz	Pulsating current amperage, TRMS AC+DC / current frequency
A $\overline{\sim}$	2	Hz	A $\overline{\sim}$ DC + AC TRMS	Frequency / pulsating current amperage, TRMS AC DC
A~	0/2	A~ AC TRMS	Hz	Alternating current amperage, TRMS AC / current frequency
Hz (A)	1	Hz ~ AC	Hz ~ AC	Current frequency / alternating current amperage, TRMS AC
\succ A $\overline{=}$	0/3	A $\overline{=}$ DC \succ	—	DC amperage with AC DC Current clamp sensor, 1 V:1/10/100/1000 A
\succ A $\overline{\sim}$	1	A $\overline{\sim}$ DC + AC TRMS \succ	Hz	Pulsating current amperage, TRMS / current frequency with AC DC current clamp sensor, see above
\succ A $\overline{\sim}$	2	Hz	A $\overline{\sim}$ DC + AC TRMS \succ	Current frequency / pulsating current amperage, TRMS, with AC DC current clamp sensor, see above
\succ A ~	0/2	A~ AC TRMS \succ	Hz	Alternating current amperage, TRMS, with Current clamp sensor, see above
Hz (\succ A)	1	Hz ~ AC \succ	~ AC	Current frequency

User Interface Symbols in the Following Sections

- ▷ ... ▷ Scroll through main menu
- ▽ ... ▽ Scroll through submenu
- ◁ ▷ Select decimal point
- △ ▽ Increase/decrease value
- ↳ *fE* Submenu/parameter (7-segment font)
- fFo*** Main menu (7-segment font, boldface)

Symbols on the Device

-  Warning concerning a point of danger (attention, observe documentation!)
-  Ground

- CAT III / IV** Measuring category III or IV device (Significance per IEC 61010-1:
 III: Measurements in building installations: stationary consumers, distributor terminals, devices connected permanently to the distributor
 IV: Measurements at power sources for low-voltage installations: Meters, mains terminals, primary over-voltage protection devices

-  Continuous, doubled or reinforced insulation

-  Indicates European Conformity

-  **▲IR ▼** Position of the infrared interface, window on the top of the instrument

-  Position of the power pack adapter socket, see also section 5.1

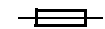
-  Fuse for current measuring ranges, see section 11.3

-  This device may not be disposed of with the trash. Further information regarding the WEEE mark can be accessed on the Internet at www.gossenmetrawatt.com under the search term WEEE (see also section 13).

Calibration Seal (blue seal):

- | | |
|----------------|-------------------------------------------------------|
| XY123 | Consecutive number |
| D-K | Deutsche Akkreditierungsstelle GmbH – calibration lab |
| 15080-01-01 | Registration number |
| 2019-04 | Date of calibration (year – month) |

See also “Recalibration” on page 66.

5 Initial Start-Up

5.1 Establishing Electrical Power Supply

You can operate the instrument either with batteries, rechargeable batteries or with the optional power pack.

Operation with Batteries or Rechargeable Batteries

Please refer to section 11.2 for instructions on how to insert (and subsequently replace) batteries.



Attention!

Observe and comply with the instructions and the safety information given in section 11.2.

Momentary battery voltage can be queried in the Info menu (see section 8.3).

Operation with power pack (accessory, not included, see section 14.3)

Installed batteries are disconnected electronically if the NA X-TRA power pack is used, and therefore need not be removed from the instrument.

If the external power supply is switched off, the device is switched to battery / rechargeable battery operation without interruption.

5.2 Switching the Instrument On

Switching the Instrument On Manually

- Press the **ON / OFF | LIGHT** key until the display appears. Power-up is acknowledged with a brief acoustic signal. As long as the key is held depressed, all of the segments at the liquid crystal display (LCD) are illuminated. The LCD is depicted on page 13. The instrument is ready for use as soon as the key is released.

Display Illumination

After the instrument has been switched on, background illumination can be activated by briefly pressing the **ON / OFF | LIGHT** key. Illumination is switched back off by once again pressing the same key, or automatically after approximately 1 minute.

Switching the Instrument On with a PC

The multimeter is switched on after transmission of a data block from the PC, assuming that the “*r5tb*” parameter has been set to “*ron*” (see section 8.4).

However, we recommend using the power saving mode: “*roff*”.



Note

Electrical discharge and high frequency interference may cause incorrect displays to appear, and may disable the measuring sequence.

Disconnect the device from the measuring circuit. Switch the instrument off and back on again in order to reset. If the problem persists, briefly dislodge the battery from the connector contacts (see also section 11.2).

5.3 Setting the Operating Parameters

Setting Time and Date

See the “ t_{FE} ” and “ $dRtE$ ” parameter in section 8.4.

5.4 Switching the Instrument Off

Switching the Instrument Off Manually

⇒ Press the **ON / OFF | LIGHT** key until **OFF** appears at the display.

Shutdown is acknowledged with a brief acoustic signal.

If hazardous contact voltage has been detected (HV symbol appears), the instrument cannot be switched off.

Automatic Shutdown

The instrument is switched off automatically if the measured value remains unchanged for a long period of time (maximum measured value fluctuation of approx. 0.8% of the measuring range per minute or 1° C or 1° per minute), and if none of the keys or rotary switch have been activated before a selected period of time in minutes has elapsed (see “ $RPdFF$ ” parameter on page 49). Shutdown is acknowledged with a brief acoustic signal.

Automatic shutdown is disabled in the following operating modes: continuous operation and whenever dangerous contact voltage has been detected (exception: memory mode).

Disabling Automatic Shutdown

The instrument can be set to continuous operation.

⇒ While switching the instrument on, simultaneously press the

 and  keys to this end.

The “Continuous On” function is indicated at by means of the **ON** display to the right of the battery symbol.

The “Continuous On” setting can only be canceled by changing the respective parameter (see “ $RPdFF$ ” page 49) or by switching the instrument off manually.

In this case, the parameter is reset to 10 minutes.

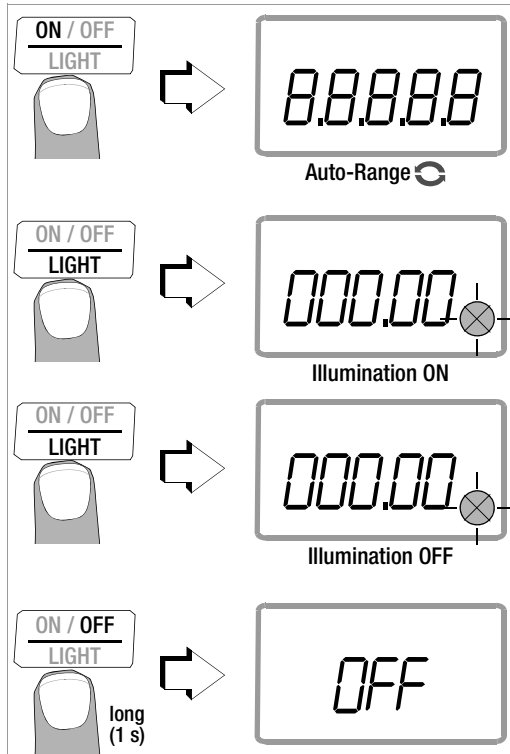

6 Control Functions

6.1 Selecting Measuring Functions and Measuring Ranges

The rotary switch is linked to the automatic socket blocking mechanism, which only allows access to two connector jacks for each function. Be certain to remove the appropriate plug from its respective jack before switching to and from the "A" functions.

The socket blocking mechanism prevents the user from inadvertently turning the selector switch to impermissible functions after the measurement cables have been plugged into the instrument.

Presence of Dangerous Touch Voltages

If dangerous voltages are applied in the high-impedance voltage measuring functions (switch position V or PQ), switching to low-impedance measuring functions (switch position MHz, Ω , continuity, temperature or capacitance) causes "HiVoLT" to appear at the display and the respective measurement is disabled. The measuring function is not switched until dangerous touch voltage is no longer applied to the input. If the instrument switches itself off in the event that hazardous touch voltage is applied (during memory mode operation with large

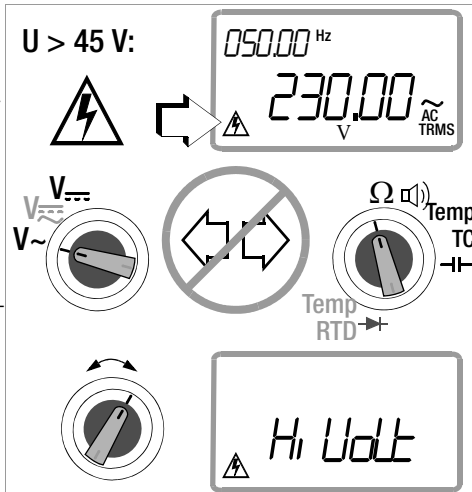

sampling period), the high-voltage warning symbol remains visible at the display.

6.1.1 Automatic Range Selection

The multimeter is equipped with auto-ranging for all measuring functions, except for temperature measurement and diode and continuity testing. Auto-ranging is active as soon as the instrument is switched on. The instrument automatically selects the measuring range which allows for highest possible resolution of the applied quantity.

AUTO-Range Function

The instrument is switched automatically to the next higher range at $\pm(310000 d + 1 d) \rightarrow 031,000$ digits, and to the next lower range at $\pm(28000 d - 1 d) \rightarrow 27,999$ digits.

The instrument automatically switches to the next higher or next lower measuring range for the following measured quantities:

Measuring Range	Resolution	Switching to Next Higher Range at $\pm(\dots d + 1 d)$	Switching to Next Lower Range at $\pm(\dots d - 1 d)$
V=, A=, Ω , Hz	5%	310,000	28,000
V~, V~, A~, A~	4%	31,000	2800
3 nF ... 3 mF	3%	3100	280

6.1.2 Manual Measuring Range Selection

Auto-ranging can be deactivated and measuring ranges can be selected manually in accordance with the following table by pressing the **MAN / AUTO** button.

The desired measuring range can then be selected with the ◀ or ▶ scroll key.

The instrument is automatically returned to automatic range selection when the **MAN / AUTO** key is pressed, the rotary switch is activated or the instrument is switched off and back on again.

Overview: Auto-Ranging and Manual Range Selection

	Function	Display
MAN / AUTO	Manual mode active: utilized measuring range is fixed	MAN
◀ or ▶	Range switching sequence for: V : 300 mV* ↔ 3V ↔ 30 V ↔ 300 V ↔ 600 V Hz (V AC) : 300 Hz ↔ 3 kHz ↔ 30 kHz ↔ 300 kHz MHz : 300 Hz ↔ 3 kHz ↔ 30 kHz ↔ 300 kHz ↔ 1 MHz Ω : 300 Ω ↔ 3 kΩ ↔ 30 kΩ ↔ 300 kΩ ↔ 3 MΩ ↔ 30 MΩ A : 300 μA ↔ 3 mA ↔ 30 mA ↔ 300 mA ↔ 3A ↔ 10 A (16 A) Hz (A AC) : 300 Hz ↔ 3 kHz ↔ 30 kHz F : 3 nF ↔ 30 nF ↔ 300 nF ↔ 3 μF ↔ 30 μF ↔ 300 μF ↔ 3 mF	MAN
MAN / AUTO	Return to automatic measuring range selection	—

* Via manual measuring range selection only

6.1.3 Quick Measurements

Measurements performed using a suitable fixed measuring range are executed more quickly than those which utilize automatic range selection. Quick measurement is made possible with the following two functions:

- **Manual measuring range selection**, i.e. selection of the measuring range with the best resolution (see section 6.1.2)
- or
- With the **DATA function** (see section 6.4). In this way, the appropriate measuring range is selected automatically after the first measurement, and the second measurement is executed more quickly.

The selected measuring range remains active for the subsequent series of measurements with these two functions.

6.2 Zero Offset / Relative Measurements

Zero offset or a reference value for relative measurements can be stored to memory depending upon deviation from the zero point:

Deviation from zero	Display
– With short-circuited measurement cables for V, Ω, A – With open input for capacitance unit of measure (F)	
0 to 200 digits	ZERO ΔREL
> 200 D to (150,000 digits) 50% of the measuring range	ΔREL

The relevant reference or correction value is deducted individually for the respective measuring function as an offset from all future measurements and remains in memory until deleted, or until the multimeter is switched off.

Zero balancing and reference value adjustment can be used for auto-ranging, as well as for manual measuring range selection.

Zero Balancing

- ⇨ Plug the measuring cables into the instrument and connect the free ends to each other, except for capacitance measurement in which case the ends of the cables are not connected to each other.
- ⇨ Briefly press the **ZERO | ESC** key.
The instrument acknowledges zero balancing with an acoustic signal, and the “ZERO ΔREL” symbol appears at the LCD. The value measured at the moment the key is pressed serves as a reference value.
- ⇨ Zero balancing can be cleared by once again pressing the **ZERO | ESC** key.



Note

As a result of TRMS measurement, the multimeter can display a residual value of 1 to 30 digits with short-circuited measurement cables as the zero point for V AC / I AC or V(AC+DC) / I (AC+DC) measurements (non-linearity of the TRMS converter). This has no influence on specified accuracy of the measuring range.

Setting the Reference Value

- ⇨ Plug the measuring cables into the instrument and measure a reference value (max. 150,000 digits, in the 10 A DC range: 50,000 digits = 50% of the measuring range).
- ⇨ Briefly press the **ZERO | ESC** key.
The instrument acknowledges storage of the reference value with an acoustic signal, and the “ZERO ΔREL” or the “ΔREL” symbol appears at the LCD. The value measured at the moment the key is pressed serves as a reference value.

- ⇨ The reference value can be cleared by once again pressing the **ZERO | ESC** key.

Notes Regarding Relative Measurement

- Relative measurement effects the main display only.
- In the case of relative measurement, Ω F or AC quantities may also appear as negative values.

6.3 Display (LCD)

Measured Value, Unit of Measure, Type of Current, Polarity

The measured value with decimal and plus or minus sign appears at the digital display. The selected unit of measure and current type are displayed as well. A minus sign appears to the left of the value during the measurement of zero-frequency quantities, if the plus pole of the measured quantity is applied to the “⊥” input.

Overranging

If the upper range limit of 31,000 digits is exceeded “OL” (overload) appears at the display.
“OL” appears at the display as of 3100 digits during capacitance measurement, as well as during continuity and diode testing.

6.4 Measured Value Storage: DATA (auto-hold / compare)

An individual measured value can be automatically “frozen” with the DATA function (auto-hold). This is useful, for example, when contacting the measuring points with the test probes requires your full attention. After the measuring signal has been applied and the measured value has settled in accordance with the “condition” listed in the table below, the measured value is frozen at the digital display and an acoustic signal is generated. The test probes can now be removed from the measuring points, and the measured value can be read from the digital display. If the measuring signal falls below the value specified in the table, the function is reactivated for storage of the next value.

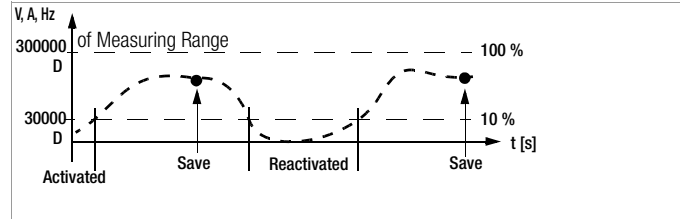

Measured Value Comparison (DATA compare)

If the currently frozen value deviates from the first saved value by less than 100 digits, the acoustic signal is generated twice. If deviation is greater than 100 digits, only a brief acoustic signal is generated.

Note

The selected measuring range cannot be manually changed as long as the DATA function is active.

The DATA function is deactivated by pressing and holding the **DATA/MIN/MAX** key (approx. 1 second), when the measuring function is changed or when the instrument is switched off and back on again.

DATA Function	Press DATA / Min-Max	Condition		Response from Instrument		
		Measuring Function	Measuring Signal	Display MV Digital	DATA	Acoustic
Activate	Brief				Blinks	Once
Save (stabilized measured value)		V, A, Hz, dB, F, %	> 10% r MR	Is displayed	Static	Once Twice ²
		Ω \square \uparrow \rightarrow	$\neq \square L$			
Reactivate ¹		V, A, Hz, dB, F, %	< 10% r MR	Stored MV	Blinks	
		Ω \square \uparrow \rightarrow	$= \square L$			
Change to Min-Max	Brief	See table in section 6.4.1				
Exit	Long			Is cleared	Is cleared	Twice

¹ Reactivation results from falling short of specified measured value limits.

² Two acoustic signals are generated the first time a measured value is saved as a reference value. For subsequent data hold, two acoustic signals are only generated if the currently frozen value deviates from the first saved value by less than 100 digits.

Key: MV = measured value, MR = measuring range

Example

The voltage measuring range is set manually to 3 V. The first measured value is 2.2 V and is stored to memory because it is greater than 5000 digits of the measuring range (= 0.3 V), and is thus reliably above the background noise level. As soon as the measured value drops to less than 3000 digits of the measuring range, i.e. amounts to less than 0.3 V which corresponds to removal of the test probes from the measuring point, the instrument is ready to store a new value.

6.4.1 Saving Minimum and Maximum Values – Min/Max Function

Minimum and maximum measured values applied to the measuring instrument's input after the Min-Max function has been activated can be "frozen" at the display. The most important use of this function is the determination of minimum and maximum values during long-term measured value observation.

The Min-Max function can be activated in all measuring functions. Apply the measured quantity to the instrument and set the measuring range with the **MAN / AUTO** key before activating the Min-Max function.

The Min-Max function is deactivated by pressing and holding the **DATA/MIN/MAX** key (approx. 1 second), when the measuring function is changed or when the instrument is switched off and back on again.



Note

As opposed to the DATA function, the Min-Max function can also be used for temperature measurement.

Function Min-Max	Press DATA / Min-Max	Min. and Max. Measured Values	Response from Instrument		
			Display Measured value, digital	Max. min.	Acous- tic Signal
1 Activate and save m	2 × short	are saved	Current measured value	Max and min	2 ×
2 Save and display	Brief	Storage continues in background, new min. and max. values are displayed.	Saved min. value	Min.	1 ×
	Brief		Saved max. value	max.	1 ×
3 Return to 1	Brief	Same as 1, stored values are not deleted	Same as 1	Same as 1	1 ×
Stop	Long	are deleted	Current measured Vvalue	is deleted	2 ×

6.5 Measurement Data Recording

The instrument is capable of recording measurement data using an adjustable sampling rate for long periods of time in the form of measurement series. Data are stored to permanent memory, and are retained even after the multimeter is switched off, and after battery replacement. The system acquires measured values relative to real-time.

Stored measured values can subsequently be read out at the computer. Connection with a PC via the Ir-USB interface adapter USB X-TRA or Bluetooth is a prerequisite (see section 9, “Interface Operation” and section 14.4, “Interface Accessories (not included)”).

Live display, recording and evaluation are also possible with the METRALOG app for Android smartphones and tablet PCs (see section 14.4, “Interface Accessories (not included)”).

6.5.1 Long-Term Recording

Preparing for Recording – Parameter Settings

- First set the **sampling rate** for memory mode operation (see *rALE* parameter on page 51).
- Set **hysteresis** for efficient use of available memory space. During memory mode operation, new measured data are only saved if they deviate from the previously stored value by an amount which exceeds the selected hysteresis value (see “*HYSL*” parameter on page 51).
- Adjust “*t.StorE*” (see page 52) in order to limit recording duration.
- First select the desired measuring function and an appropriate measuring range.
- Check the battery charge level before starting long-term mea-

surement recordings (see section 11.2).

Connect the NA X-TRA power pack if required.

Memory Parameters Overview

Parameter	Page: header
<i>CLEAR</i>	25: Clear Memory
<i>EMPTY</i>	25: Clear Memory – appears after <i>CLEAR</i>
<i>HYSL</i>	51: HYSL – Hysteresis (parameter for memory mode operation)
<i>OCCUP</i>	25: Querying Memory Occupancy
<i>rALE</i>	51: rALE – Set Transmission and Storage Rate
<i>StArt</i>	24: Starting Recording via Menu Functions
<i>StoP</i>	25: Ending Recording
<i>trIG</i>	52: triG – Trigger Conditions (parameters for memory mode operation)
<i>tStorE</i>	52: tStorE – Recording Time (parameter for memory mode operation)

Starting Recording via Menu Functions

- Switch to the “*SEtUP*” mode by pressing **MEASURE | SETUP** and select the “*StorE*” menu.

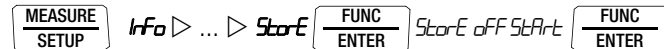

- Memory mode operation is started by acknowledging with **FUNC | ENTER**. **STORE** appears in the header and indicates that the memory mode has been activated. “*StorE*” appears at the main display. If trigger conditions are activated, **TRIG** also blinks in the header.
- Press the **MEASURE | SETUP** key in order to return to the measuring function.

Ending Recording

- ⇨ If the instrument is in the measuring mode, return to the menu function by pressing the **MEASURE | SETUP** key. Select “**StorE**” again and acknowledge by pressing the **FUNC | ENTER** key. “**StorE**” blinks at the main display.

StorE on **StorE**  *StorE*

- ⇨ Acknowledge the “**StorE**” display by pressing **FUNC | ENTER**. The **STORE** display segment in the header is cleared, indicating that recording has been ended.
- ⇨ Press the **MEASURE | SETUP** key in order to return to the measuring function.
- ⇨ Memory mode operation can also be exited by switching the multimeter off.



Note

As soon as the internal memory is full, the recording ends automatically.
Before recording, check the memory occupancy and set the parameters (especially the sampling rate) accordingly (see page 24).

Querying Memory Occupancy

Memory occupancy can be queried during recording with the help of the “**Info**” menu (see also section 8.3).

Memory occupancy range: 000. % to 099.9%.

 **Info**  *bAtt* ▾ ▾ *OCCUP %* 0 17.4 %

Clear Memory

This function deletes all measured values from memory!

It's advisable to execute this function before starting a new measurement data recording.

 **Info** ▷ ... ▷ *StorE*  *StorE* off **Start** (blinks)

▽ *StorE CLEAR*  *StorE CLEAR no* ▷ **YES** 

StorE EMPTY (appears briefly) → *StorE*

6.5.2 Storage of Individual Values using the **SAMPLE** or **dAtA** Sampling Rate

If only individually selected values need to be saved, **SAMPLE** must be selected as the StorE > rAtE sampling value. If memory mode operation is then started, a single measured value is saved to permanent memory with time stamp when the **DATA/MIN/MAX** key is pressed and held until two rapidly repeating acoustic signals are generated.

If **dAtA** is selected as the StorE > rAtE sampling rate, and if memory mode operation is then started, measured values ascertained with activated DATA function are automatically saved to permanent memory with time stamp.

7 Measurements

7.1 Voltage Measurement

Notes Regarding Voltage Measurement

- **The multimeter may only be operated with installed batteries or rechargeable batteries.** Dangerous voltages are otherwise not indicated, and the instrument may be damaged.
- The multimeter may only be operated by persons who are capable of recognizing **contact hazards** and taking the appropriate safety precautions. Contact hazards exist anywhere, where voltages of greater than 33 V (RMS) may occur. The test probes may only be gripped up to the finger guard. Do not touch the metallic test probes under any circumstances.
- Avoid working alone when taking measurements which involve **touch hazards**. Be certain that a second person is present.
- **The maximum allowable voltage** between the connector sockets and ground is 600 V for measuring category III and 300 V for measuring category IV.
- Be prepared for the occurrence of unexpected voltages at devices under test (e.g. defective devices). For example, capacitors may be dangerously charged.
- No measurements may be made with this instrument in electrical circuits with corona discharge (high-voltage).
- Special care is required when measurements are made in HF electrical circuits. Dangerous pulsating voltages may be present.
- **Be aware of the fact that dangerous voltage spikes are not displayed during measurement with the low-pass filter. We recommend measuring voltage without the low-pass filter first, in order to be able to detect any dangerous voltages.**

- Be absolutely certain that the **measuring ranges are not overloaded beyond their allowable capacities**. Limit values are included in section 10, “Technical Data” in the table entitled “Measuring Functions and Measuring Ranges” in the “Overload Capacity” column.
- **300 mV range:** Thermovoltages occur in the event of temperature fluctuation, which appear as additional voltage offset. It may be necessary to repeat zero offsetting in order to achieve the specified degree of accuracy.

Scope of Functions, Voltage Measurement

Function	METRAstHIT PM PRIME METRAHIT PM PRIME BT
V AC / Hz TRMS, dB ($R_i = 5 \text{ M}\Omega$) ¹	•
V AC / TP-Filter 1 kHz ¹ ($R_i = 5 \text{ M}\Omega$) TRMS	•
V AC+DC TRMS / TP-Filter ($R_i = 5 \text{ M}\Omega$)	•
V DC ($R_i = 10 \text{ M}\Omega$)	•
Pulse frequency, MHz @ 5 V TTL	•
Duty cycle as %	•
Voltage level measurement, dB	@ V_{AC} @ V_{AC+DC}
Frequency bandwidth	100 kHz

¹ A 1 kHz low-pass filter can be used in this case, in order to filter out high frequency pulses of greater than 1 kHz, for example when performing measurements at pulsed motor drives.

7.1.1 Direct and Pulsating Voltage Measurement, V DC and V (DC+AC)



Note

Set the CL, P parameter to **OFF** in the current clamp setup menu. Otherwise all measured values are displayed in amperes, corrected by the amount resulting from the selected transformation ratio for an interconnected current clamp sensor.

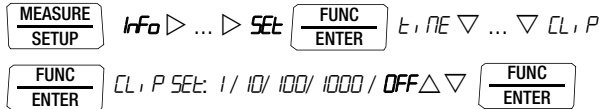

- In accordance with the voltage to be measured, turn the rotary switch to V_{DC} or V_{AC} .
- Connect the measurement cables as shown. The “L” connector jack should be grounded.



Note

An intermittent acoustic signal warns the operator if the measured value exceeds the upper range limit in the 600 V range.

Make sure that a current measuring range (“A”) has not been activated when the multimeter is connected for voltage measurement! If the fuse’s blowing limits are exceeded as a result of operator error, both the operator and the instrument are in danger!

With the rotary switch in the V position, the multimeter is always in the 3 V measuring range immediately after it is switched on. As soon as the **MAN / AUTO** key is pressed, and assuming the measured value is less than 300 mV, the multimeter is switched to the mV measuring range.

$CL, P = OFF!$

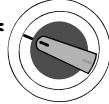

V_{DC}



V_{DC}

$CL, P = OFF!$



V_{AC}

1kHz
dB



Hz

V_{AC}

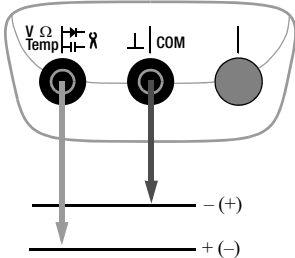

V Temp | → ← | COM |

— (+)

— (-)

Measuring Ranges:

V_{DC} : 300 mV...600 V

V_{AC} : 300 mV...600 V



Hz: 5 Hz ... 300 kHz

Max. 600 V (< 5 kHz)

Max. 100 V (> 10 kHz)

$P_{\text{max}} = 3 \times 10^6 \text{ V} \times \text{Hz}$
for $U > 100 \text{ V}$

Warnings regarding dangerous voltage:

> 45 V:  

> 600 V: 

Frequency Measurement in the V (DC+AC) Switch Position

- Connect the measured quantity in the same way as for voltage measurement.
- Manually select the measuring range for the voltage amplitude.
- Repeatedly press the multifunction key **FUNC | ENTER** until the unit of measure Hz appears at the display. Lowest measurable frequencies and maximum allowable voltages are listed in section 10, "Technical Data".

Measurement with Low-Pass Filter



Attention!

Be aware of the fact that dangerous voltage spikes are not displayed during this type of measurement (see also "Voltage Comparator"). We recommend measuring voltage without the low-pass filter first, in order to be able to detect any dangerous voltages.

A 1 kHz low-pass filter can be activate if required, in order to filter out high frequency pulses of greater than 1 kHz, for example when performing measurements at pulsed motor drives, i.e. undesired voltages of greater than 1 kHz can be suppressed.

The active low-pass filter is indicated by the **FILTER** display. The multimeter is automatically switched to manual measuring range selection.

Specified measuring accuracy is not reached with signals of greater than 100 Hz when the filter is active.

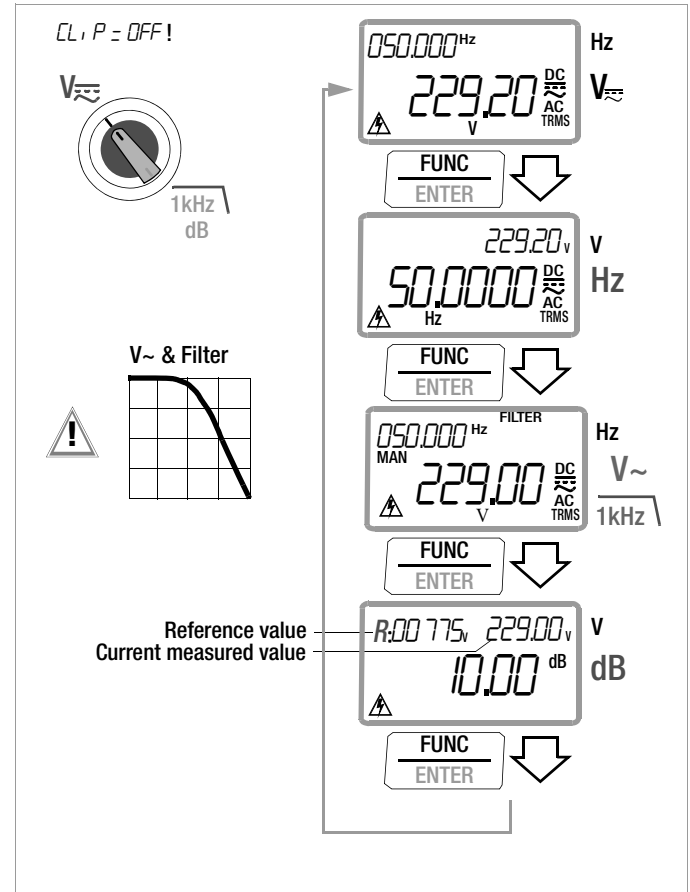

7.1.2 Alternating Voltage and Frequency Measurement V AC and Hz V AC with Selectable Low-Pass Filter, V AC + FiL and dB V AC



Note

See note in section 7.1.1.

- ⇨ In accordance with the voltage or frequency to be measured, turn the rotary switch to V~.
- ⇨ Connect the measurement cables as shown. The “⊥” connector jack should be grounded.

Voltage Measurement



Note

An intermittent acoustic signal warns the operator if the measured value exceeds the upper range limit in the 600 V range.

Make sure that a current measuring range (“A”) has not been activated when the multimeter is connected for voltage measurement! If the fuse’s blowing limits are exceeded as a result of operator error, both the operator and the instrument are in danger!

- ⇨ You can switch back and forth between voltage measurement with and without low-pass filter.
- ⇨ Repeatedly press the multifunction key **FUNC | ENTER** until unit of measure V in appears at the main display, and **FILTER** appears in the header for measurement with low-pass filter.

Frequency Measurement

- ⇨ Connect the measured quantity in the same way as for voltage measurement.
 - ⇨ Manually select the measuring range for the voltage amplitude.
 - ⇨ Repeatedly press the multifunction key **FUNC | ENTER** until unit of measure Hz appears at the display. Lowest measurable frequencies and maximum allowable voltages are listed in section 10, “Technical Data”.
-



Note

Measurements performed close to the trigger level may result in an incorrect display. If this is the case, select a smaller voltage measuring range.

In the case of measured values which are much higher than the expected results, the input signal may be distorted. Perform measurement with activated 1 kHz low-pass filter in this case.

Measurement with Low-Pass Filter



Attention!

Be aware of the fact that dangerous voltage spikes are not displayed during this type of measurement (see also “Voltage Comparator”. We recommend measuring voltage without the low-pass filter first, in order to be able to detect any dangerous voltages.

A 1 kHz low-pass filter can be activate if required, in order to filter out high frequency pulses of greater than 1 kHz, for example when performing measurements at pulsed motor drives, i.e. undesired voltages of greater than 1 kHz can be suppressed.

The active low-pass filter is indicated by the FILTER display. The multimeter is automatically switched to manual measuring range selection.

Specified measuring accuracy is not reached with signals of greater than 100 Hz when the filter is active.

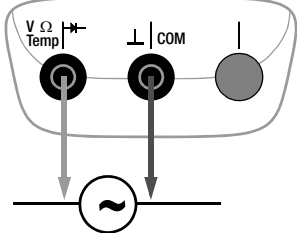

V Ω Temp μ | COM |

Measuring Ranges:
V~: 300 mV ... 600 V
Max. 600 V (< 5 kHz)
Max. 100 V (> 10 kHz)
Hz: 5 Hz ... 300 kHz
 $P_{max} = 3 \times 10^6 \text{ V} \times \text{Hz}$
 for $U > 100 \text{ V}$

Warnings regarding dangerous voltage:

> 45 V: 230.0

> 600 V:

Voltage Comparator for Displaying Dangerous Voltage

The input signal or measuring signal is checked by a voltage comparator for dangerous spikes, because these do not appear at the display when the low-pass filter is used.

Where $U > 45 \text{ V}$, a danger symbol appears at the display.

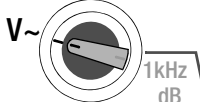



FUNC ENTER



FUNC ENTER



FUNC ENTER

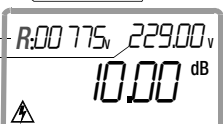

FUNC ENTER

V~ & Filter

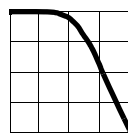

Reference value \rightarrow 8.00 775, 229.00 V

Current measured value \rightarrow 10.00 dB

Alternating Voltage Level Measurement (dB)

Voltage level measurement is used in order to ascertain overall attenuation or boosting of a transmission system (shown here as a 4-pole setup).

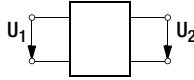

$$\text{VoltageLevel[dB]} = 20 \cdot \log \frac{U_2}{U_1}$$

Where $U_1 = U_{\text{REF}}$ (reference level) = 0.775 V

Result > 1: boosting

Result < 1: attenuation

- ⇨ Manually select the measuring range for the voltage amplitude. When the instrument is switched to dB measurement, the previously selected voltage measuring range remains active.
- ⇨ Repeatedly press the multifunction key **FUNC | ENTER** until unit of measure dB appears at the display. Lowest measurable frequencies and maximum allowable voltages are listed in section 10, "Technical Data".

The level measurement function is now activated. The measured value is calculated based upon the RMS value of the alternating voltage component relative to the measuring range (300 mV to 600 V), and displayed.

The default value for the reference level is 0 dB = 0.775 V (1 mW to 600 Ω). This value is a fixed setting and is displayed at the left-hand auxiliary display (R:00.775 v).

Note

No terminal resistors have been integrated into the device. It performs measurement with a high input impedance of 5 M Ω .

Input impedance for voltage measurement is listed under technical data.

In order to be able to perform correct measurement at non-terminated devices under test, the terminating resistor must be connected to the terminals. Be sure to take power loss at the terminating resistor into consideration!

7.1.3 Frequency and Duty Cycle Measurement

- Set the rotary switch to MHz or %.
- Connect the measurement cables as shown.

Make sure that a current measuring range (“A”) has not been activated when the multimeter is connected for frequency or duty cycle measurement!



Attention!

The applied signal voltage may not exceed 5 V.

Frequency Measurement, MHz

A 5 V signal with a frequency of up to 1 MHz is measured and displayed using MHz as a unit of measure. The pulse frequency is the reciprocal value of the pulse period.

Duty Cycle Measurement t_E/t_P

The ratio of pulse duration to pulse period is measured with periodic square-wave signals and is displayed as a percentage.

$$\text{Duty cycle (\%)} = \frac{\text{Pulse duration } (t_E)}{\text{Pulse period } (t_P)} \cdot 100$$



Note

The applied frequency must remain constant during duty cycle measurement.

MHz

0.10323 kHz

Hz

002.00 %

MHz

f_P

Hz

t_E/t_P

↓ **FUNC** ↑

ENTER

Pulse Time Quantities

f_P pulse frequency = $1/t_P$

t_E pulse duration

t_P pulse period

$t_P - t_E$ interpulse period

t_E/t_P pulse or duty cycle

Measuring Ranges:

Hz	t_E/t_P
15 Hz to 1 kHz	2 to 98%
Up to 10 kHz	5 to 95%

V Ω Temp \rightarrow | COM |

Max. 5 V

7.2 Resistance Measurement Ω

- ⇨ Disconnect supply power from the electrical circuit of the device to be measured, and discharge all high-voltage capacitors.
- ⇨ Make sure that the device under test is voltage-free. Interference voltages distort measurement results! Refer to section 7.1.1 regarding testing for the absence of voltage with the help of the direct voltage measurement.
- ⇨ Set the rotary switch to " Ω ".
- ⇨ Connect the device under test as shown.

Note

Use short or shielded measurement cables in the case of high-impedance resistance.

Ω : "OL" appears at the display in the case of an open connection.

Improving Accuracy by means of Zero Balancing

Cable resistance and contact resistance can be eliminated in all measuring ranges by means of zero balancing (see section 6.2).

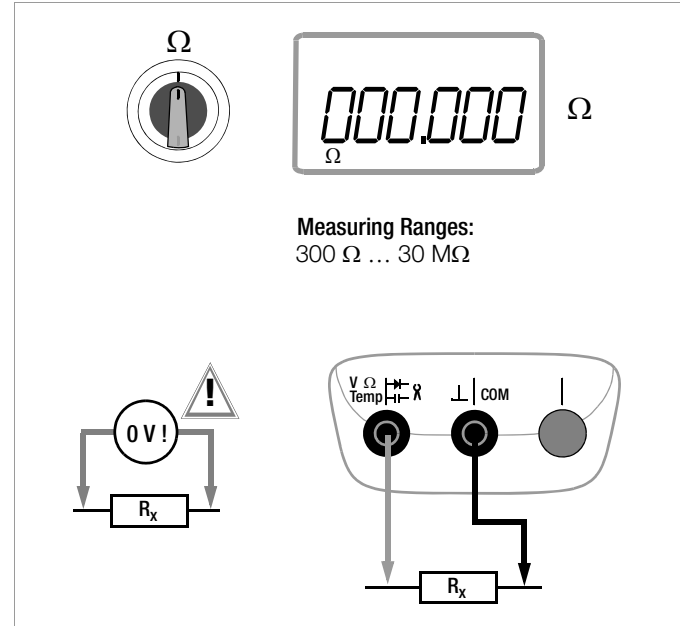

7.3 Continuity Test Ω) with Constant Current of 1 mA

- Disconnect supply power from the electrical circuit of the device to be measured, and discharge all high-voltage capacitors.
 - Make sure that the device under test is voltage-free. Interference voltages distort measurement results!
 - Set the rotary switch to Ω).
 - Connect the conductor path under test as shown.
- “OL” appears at the display in the case of an open connection. Open circuit voltage is less than 4.5 V.

Limit Value for Volume Resistance

Depending upon the selected limit value, the multimeter generates a continuous acoustic signal in the case of continuity or short-circuiting, i.e. at a value of less than the selected limit value. The limit value can be adjusted in the “**SET**” menu (see also section 8.4):



(10 = default setting)

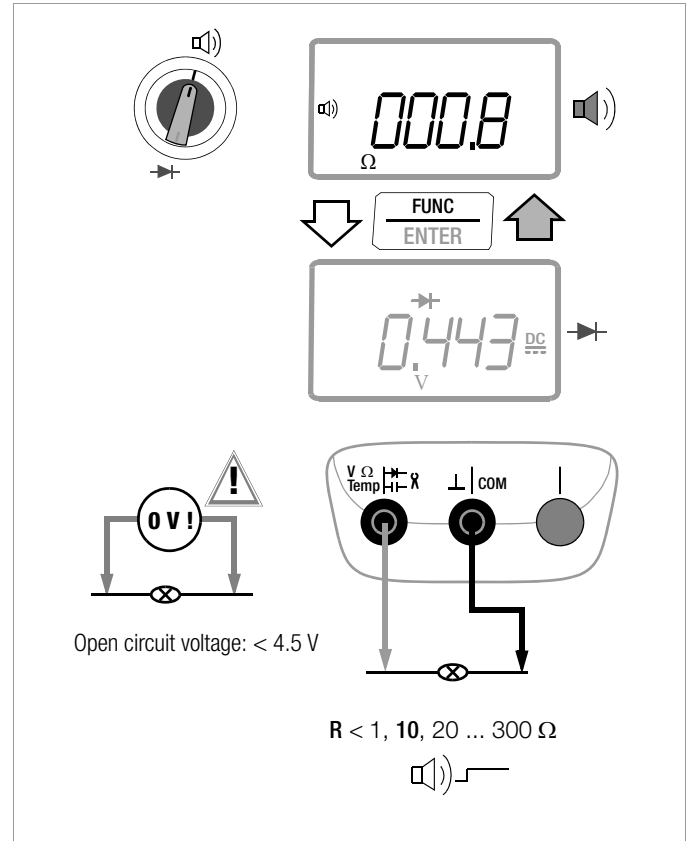

7.4 Diode Testing \rightarrow with Constant Current of 1 mA

- ⇨ Disconnect supply power from the electrical circuit of the device to be measured, and discharge all high-voltage capacitors.
- ⇨ Make sure that the device under test is voltage-free. Interference voltages distort measurement results!
Refer to section 7.1.1 regarding testing for the absence of voltage with the help of the direct voltage measurement.
- ⇨ Set the rotary switch to \rightarrow .
- ⇨ Acknowledge by pressing the **FUNC | ENTER** key.
- ⇨ Connect the device under test as shown.

Forward Direction and Short-Circuit

The instrument displays forward voltage in volts (display: 4 places). As long as voltage drop does not exceed the maximum display value of 4.5 V, several series connected components or reference diodes can be tested with a small reference voltage and Z-diodes.

Reverse Direction and Interruption

The measuring instrument indicates overload: "OL".



Note

Resistors and semiconductor paths connected in parallel to the diode distort measurement results!



Attention!

Observe high open-circuit voltage of 6 V during diode testing: Circuits must be laid out accordingly.

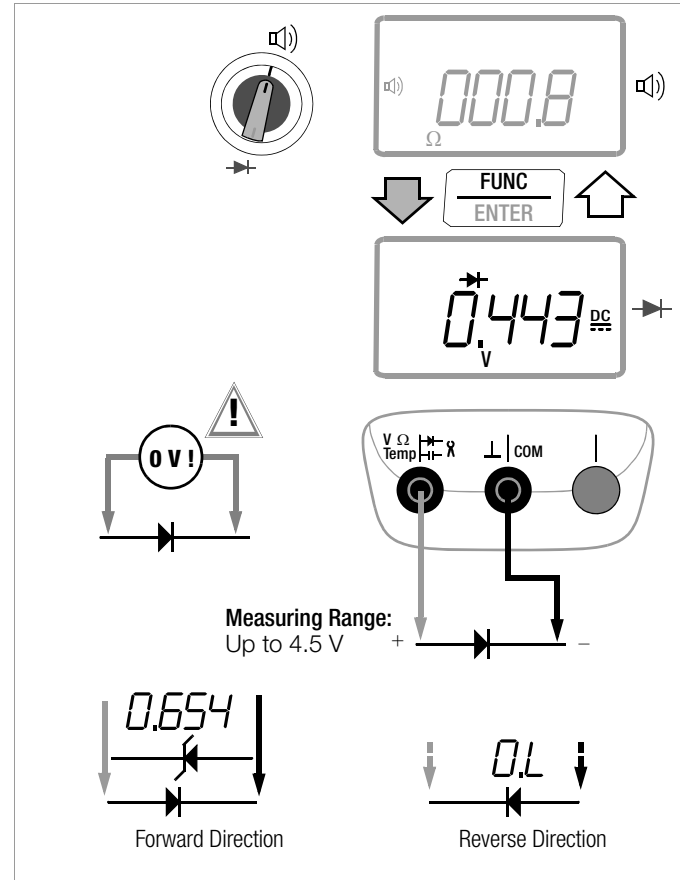

7.5 Temperature Measurement

Temperature measurement is performed with a type K thermocouple or a type Pt100 or Pt1000 resistance sensor (accessory, not included) which is connected to the voltage input.

Selecting the Unit of Measure for Temperature (°C = default value)

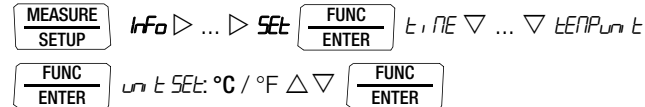

7.5.1 Measurement with Thermocouples, Temp TC

⇨ Set the rotary switch to “Temp_{TC}”.

Note

The last selected temperature measurement or the last selected temperature sensor, i.e. type K or Pt100/Pt1000, remains in memory and is accordingly displayed. Press the **FUNC | ENTER** key in order to change to the other measuring function.

⇨ Either the internal reference junction (“*TEMP_{INT} REF_{INT}*” parameter, see also page 50) or an external reference temperature can be specified as the reference temperature (see page 50). The type (“I.” for internal or “E.” for external) and temperature of the selected reference junction appears at the right-hand auxiliary display during measurement.

Note

The internal reference temperature (temperature of the internal reference junction) is measured by a temperature sensor inside of the instrument. This may deviate somewhat from room temperature as a result of internal heat-up, or moving from warmer to colder surroundings or vice versa.

⇨ Connect the sensor to the two accessible jacks. The instrument displays the measured temperature using the selected unit of measure.

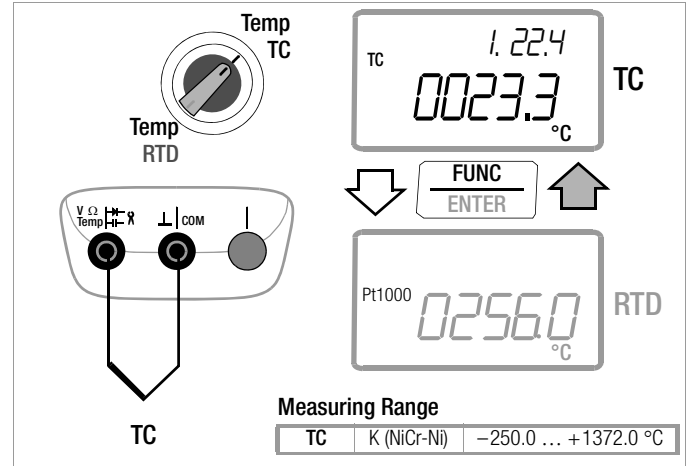

Note

After previously performing a 10 A current measurement, the measuring instrument should be allowed to cool down for 30 minutes before performing measurements with thermocouples, in order to assure that the specified accuracy levels are achieved.

7.5.2 Measurement with Resistance Sensors

- ⇨ Set the rotary switch to “Temp_{TC}” or “Temp_{RTD}”.

The last selected temperature measurement or the last selected temperature sensor, i.e. type K or Pt100/Pt1000, remains in memory and is accordingly displayed. Press the **FUNC | ENTER** key in order to change to the other measuring function.

The sensor type, i.e. Pt100 or Pt1000, is detected automatically and displayed.

There are two different ways to compensate for cable resistance:

Automatic Compensation

- ⇨ Acknowledge by pressing the **ZERO | ESC** key. “Short leads” appears at the display.

If you prefer to enter cable resistance directly, you can skip the following entry prompt.

- ⇨ Short circuit the measuring instrument’s connector cables. “000.00” appears at the display. After pressing the **FUNC | ENTER** key, automatic compensation of cable resistance is activated for all subsequent measurements. The short-circuit can now be eliminated, and the device is ready for use.

Entering Cable Resistance

- ⇨ Press the **ZERO | ESC** key once again in the automatic compensation menu.
- ⇨ Enter the known resistance of the connector cables with the scroll keys: Select the digit to be changes with the $\triangleleft \triangleright$ keys, and change the respectively selected digit with the $\nabla \triangle$ keys. The default value is 0.16 Ω (Z3409). Values can be selected within a range of 0 to 50 Ω.

- ⇨ Upon pressing the **FUNC | ENTER** key, the selected value is activated and the display is returned to the measuring function. Cable resistance remains in memory even after the instrument has been switched off.

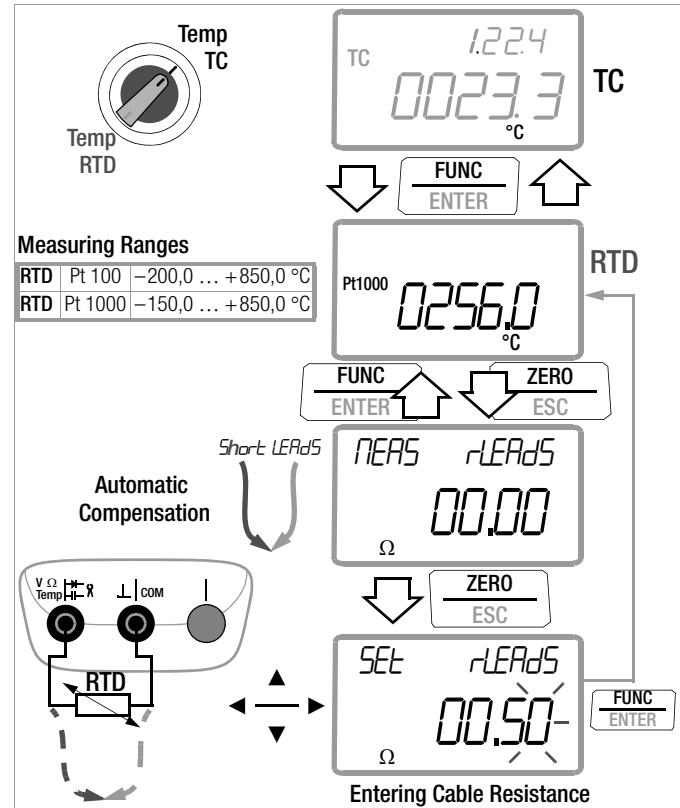

7.6 Capacitance Measurement μF

- ❖ Disconnect supply power from the electrical circuit of the device to be measured, and discharge all high-voltage capacitors.
- ❖ Make sure that the device under test is voltage-free. Capacitors must always be discharged before measurement is performed. Interference voltages distort measurement results! Refer to section 7.1.1 regarding testing for the absence of voltage with the help of the direct voltage measurement.
- ❖ Set the rotary switch to “ μF ”.
- ❖ Connect the (discharged!) device under test to the sockets with the measurement cables as shown.

Note
 The “-” pole of polarized capacitors must be connected to the “L” jack.
 Resistors and semiconductor paths connected in parallel to the capacitor distort measurement results!

Note
 Use of the power pack may result in significant deviations during capacitance measurements!

Note
 This function is above all intended for the measurement of components. For telecommunication systems, it's advisable to use the special capacitance measurement for measurements in symmetrical copper cable networks with the **METRAHIT | T-COM PLUS** (M246S) cable multimeter.

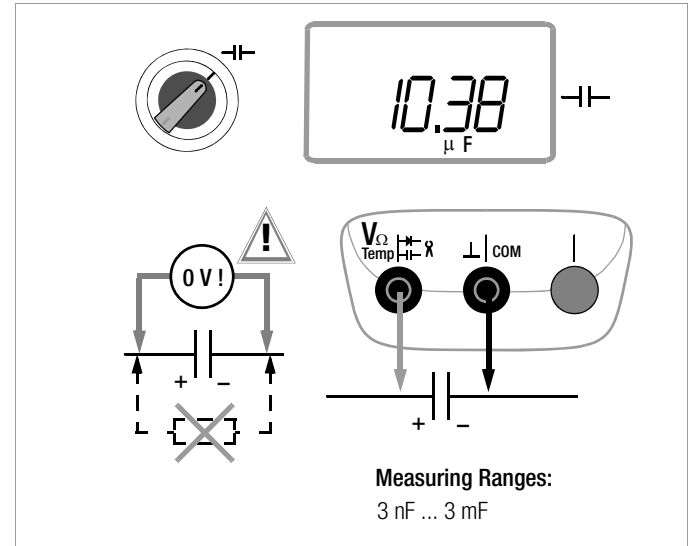

7.7 Current Measurement

Notes Regarding Current Measurement

- **The multimeter may only be operated with installed batteries or rechargeable batteries. Dangerous currents are otherwise not indicated, and the instrument may be damaged.**
- Set up the measuring circuit in a mechanically secure fashion, and secure it against inadvertent breaks. Select conductor cross-sections and lay out connections such that they do not overheat.
- An intermittent acoustic signal warns of current greater than 10 A. An continuous acoustic signal warns of current greater than 16 A.
- When measuring high current values, limit them to max. 16 A for 30 seconds or 10 A for max. 5 minutes, and allow the multimeter to cool down for 10 minutes between measurements.
- For purposes of orientation, internal temperature in close proximity to the jacks is displayed at the right-hand auxiliary display in the 3 A and 10 A or 16 A ranges. If temperature rises to above 50° C, you are warned by an intermittent acoustic signal.
- The input for the current measuring range is equipped with a fuse link. Maximum permissible voltage for the measuring circuit (= rated voltage of the fuse) is 600 V AC/DC. Use specified fuses only! The fuse must have a **breaking capacity of at least 30 kA**.
- If the fuse for the active current measuring range blows, "FUSE" appears at the digital display, and an acoustic signal is generated at the same time.
- If a fuse should blow, eliminate the cause of overload before placing the instrument back into service!
- Fuse replacement is described in section 11.3.

- Be absolutely certain that the measuring ranges are not overloaded beyond their allowable capacities. Limit values are included in section 10, "Technical Data" in the table entitled "Measuring Functions and Measuring Ranges" in the "Overload Capacity" column.

*Scope of Functions, Current Measurement, Direct Connection

Function	Switch Position	Measuring Range
Transformation ratio \times C	SEt menu, ClIP=OFF	
A DC \equiv	A \equiv	300 μ A 3 / 30 / 300 mA 3 / 10 A (16 A)
A AC+DC TRMS / Hz (A AC) \approx	A \approx	
A AC / Hz (A AC) \sim	A \sim	
Hz (A AC+DC) / A AC+DC TRMS \approx	A \approx	Up to 30 kHz
Hz (A AC) / A AC \sim	Hz	

Scope of Functions, Current Measurement with Current Clamp Sensor

Function	Switch Position
Transformation ratio \times C	SEt menu, ClIP=OFF
A DC \times C	V \equiv
A AC+DC \times C / Hz (A AC) \approx	V \approx
Hz (A AC) \times C / A AC+DC	Hz
A AC \times C / Hz (A AC) \sim	V \sim
Hz (A AC) \times C / A AC	Hz

Scope of Functions, Current Measurement with Current Clamp Transformer

Function	Switch Position
Transformation Ratio \times C	SEt menu, ClIP=OFF
A DC \times C	A \equiv
A AC+DC \times C / Hz (A AC) \approx	A \approx
Hz (A AC) \times C / A AC+DC	A \approx
A AC \times C / Hz (A AC) \sim	A \sim
Hz (A AC) \times C / A AC	Hz

7.7.1 Direct and Pulsating Current Measurement, Direct Connection, A DC and A (DC+AC)

- First disconnect supply power from the measuring circuit or the power consumer, and discharge any capacitors.
- In accordance with the current to be measured, set the rotary switch to A \equiv or A \approx .
- Select the type of current appropriate for the measured quantity by briefly pressing the multifunction key **FUNC | ENTER**. Each time the key is pressed, the instrument is switched back and forth between A DC and A (DC + AC)_{TRMS}, which is indicated by means of an acoustic signal. The current type is indicated at the LCD by means of the DC or the (DC+AC)_{TRMS} symbol.
- Safely connect the measuring instrument (without contact resistance) in series to the power consumer as shown.
- Switch supply power to the measuring circuit back on.
- Read the display. Make a note of the measured value if the instrument is not being operated in the memory mode or the transmission mode.
- Disconnect supply power from the measuring circuit or the power consumer once again, and discharge any capacitors.
- Remove the test probes from the measuring point and return the measuring circuit to its normal condition.
- Direct frequency measurement, A (DC + AC)_{TRMS} (see following section).

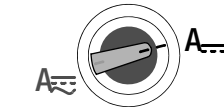

Current measurement may only be performed with installed batteries!





FUNC | ENTER



Measuring Ranges:

- 300 mA / 3 mA
- 30 mA / 300 mA
- 3 A / 10 A (10 A max. 5 min)
- (16 A max. 30 s)

* Additional temperature display (internal temperature at jacks) in the 3 A and 10 A ranges

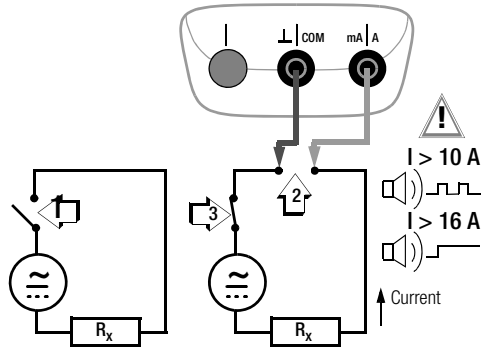

7.7.2 Alternating Current and Frequency Measurement, Direct Connection, A AC and Hz

- First disconnect supply power from the measuring circuit or the power consumer, and discharge any capacitors.
- In accordance with the current or frequency to be measured, turn the rotary switch to A~ or Hz.
- Select the desired measured quantity by briefly pressing the multifunction key **FUNC | ENTER**. Each time the key is pressed, AC_{TRMS} and Hz are alternately selected, and switching is acknowledged with an acoustic signal.
- Safely connect the measuring instrument (without contact resistance) in series to the power consumer as shown.
- Switch supply power to the measuring circuit back on.
- Read the display. Make a note of the measured value if the instrument is not being operated in the memory mode or the transmission mode.
- Disconnect supply power from the measuring circuit or the power consumer once again, and discharge any capacitors.
- Remove the test probes from the measuring point and return the measuring circuit to its normal condition.

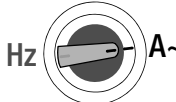

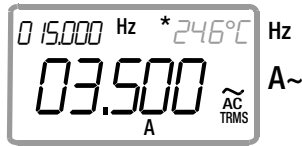

Hz A~



0 15.000 Hz * 24.6°C Hz
03.500 A AC TRMS



Current measurement may only be performed with installed batteries!







8.8.8.8



FUNC | ENTER



* 24.6°C 03.500 A Hz
050.100 A AC TRMS



I > 10 A
I > 16 A

* Additional temperature display (internal temperature at jacks) in the 3 A and 10 A ranges

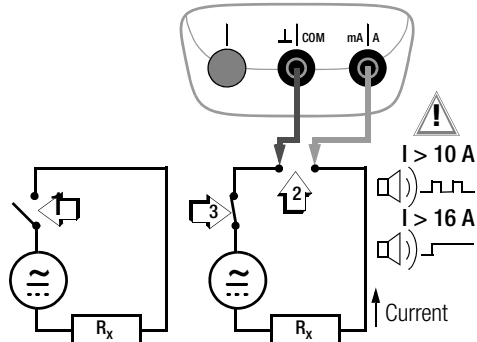

COM mA | A

1 2 3

R_x R_x

Current

7.7.3 Direct and Pulsating Current Measurement with Current Clamp Sensor, A DC and A (DC+AC)

Voltage/Current Transformer Output

When a current clamp sensor is connected to the multimeter (V A input), all current displays appear with the correct value in accordance with the selected transformation ratio. The only prerequisite is that the current sensor is equipped with at least one of the below listed transformation ratios, and that the ratio has been previously selected in the following menu (**CL**, **P** ≠ **OFF**) (see also section 8.4).

Current Clamp Setup Menu

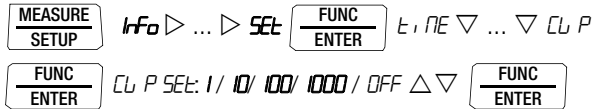

Transformation ratios: <i>CL, P</i>	DMM Measuring Ranges			Clamp Types
	300 mV	3 V	30 V	
1:1 1mV/1mA	300.00 mA	3.0000 A	30.000 A	WZ12C
1:10 1mV/10mA	3.0000 A	30.000 A	300.00 A	WZ12B, Z201A/B METRAFLEX
1:100 1mV/100mA	30.000 A	300.00 A	3000.0 A	Z202A/B, METRAFLEX
1:1000 1 mV/1 A	300.00 A	3000.0 A	30000 A	Z202A/B, Z203A/B, WZ12C, METRAFLEX

The maximum allowable operating voltage is equal to the nominal voltage of the current transformer. When reading the measured value, additional error resulting from the current clamp sensor must also be taken into consideration (default setting: **1:1000**).

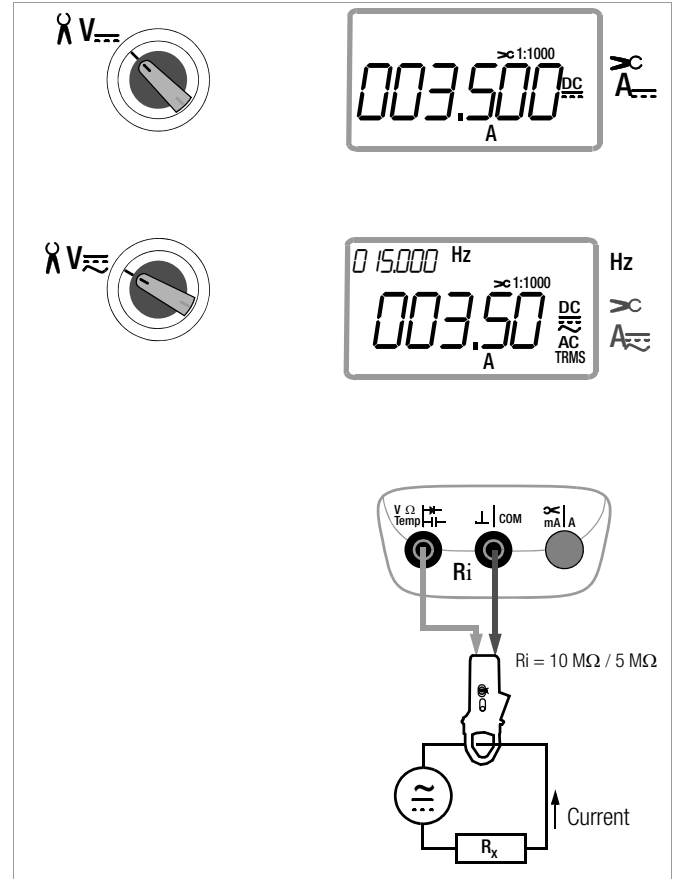

7.7.4 Alternating Current Measurement with Current Clamp Sensor, A AC and Hz

Voltage/Current Transformer Output

When a current clamp sensor is connected to the multimeter (V \rightarrow input), all current displays appear with the correct value in accordance with the selected transformation ratio. The only prerequisite is that the current sensor is equipped with at least one of the below listed transformation ratios, and that the ratio has been previously selected in the following menu (CL, P \neq OFF) (see also section 8.4).

Current Clamp Setup Menu

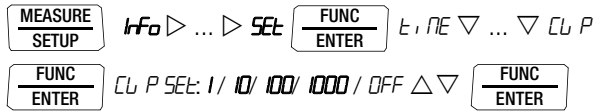

Transformation ratios: CL, P	DMM Measuring Ranges			Clamp Types
	300 mV	3 V	30 V	
1:1 1mV/1mA	300.00 mA	3.0000 A	30.000 A	WZ12C
1:10 1mV/10mA	3.0000 A	30.000 A	300.00 A	WZ12B, Z201A/B METRAFLEX
1:100 1mV/100mA	30.000 A	300.00 A	3000.0 A	Z202A/B, METRAFLEX
1:1000 1 mV/1 A	300.00 A	3000.0 A	30000 A	Z202A/B, Z203A/B, WZ12C, METRAFLEX

The maximum allowable operating voltage is equal to the nominal voltage of the current transformer. When reading the measured value, additional error resulting from the current clamp sensor must also be taken into consideration (default setting: **1:1000**).

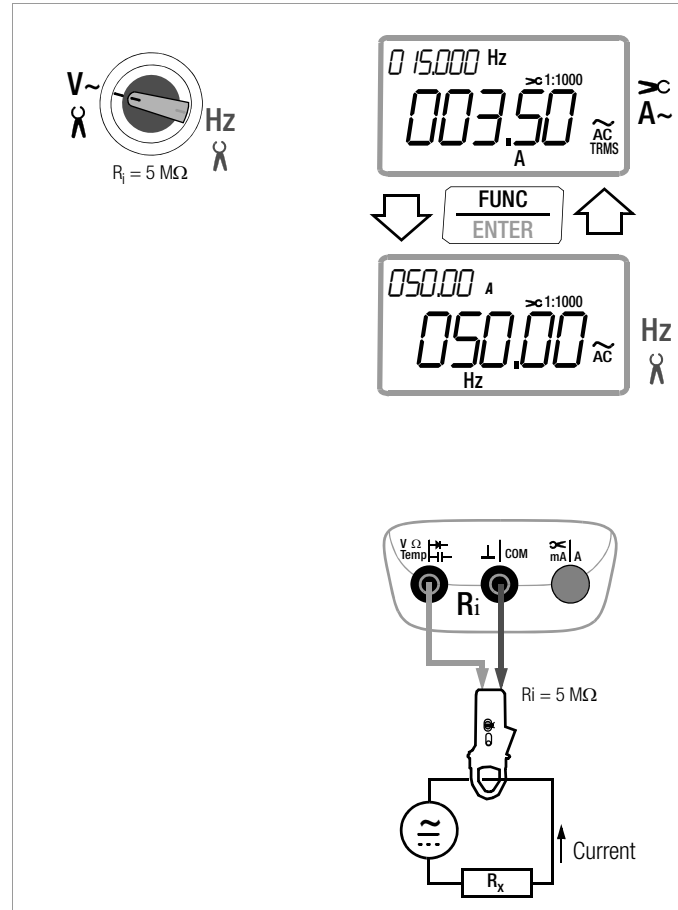

7.7.5 Alternating Current Measurement with Current Clamp Transformer, A AC and Hz

Current/Current Transformer Output

When a current clamp transformer is connected to the multimeter (A mA/A input), all current displays appear with the correct value in accordance with the selected transformation ratio. The only prerequisite is that the current transformer is equipped with at least one of the below listed transformation ratios, and that the ratio has been previously selected in the following menu ($CL, P \neq OFF$) (see also section 8.4).

Current Clamp Setup Menu

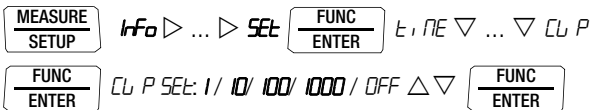

Transformation ratios: <i>CL, P</i>	DMM Measuring Ranges			Clamp Types
	30 mA AC	300 mA AC	3 A AC *	
1:1 1mA/1mA	30.000 mA	300.00 mA	3.0000 A	WZ12A, WZ12D, WZ11A, Z3511, Z3512, Z3514
1:10 1mA/10mA	300.00 mA	3.0000 A	30.000 A	
1:100 1mA/100mA	3.0000 A	30.000 A	300.00 A	
1:1000 1 mA/1 A	30.000 A	300.00 A	3000.0 A	

(default setting: $CL, P = OFF$)

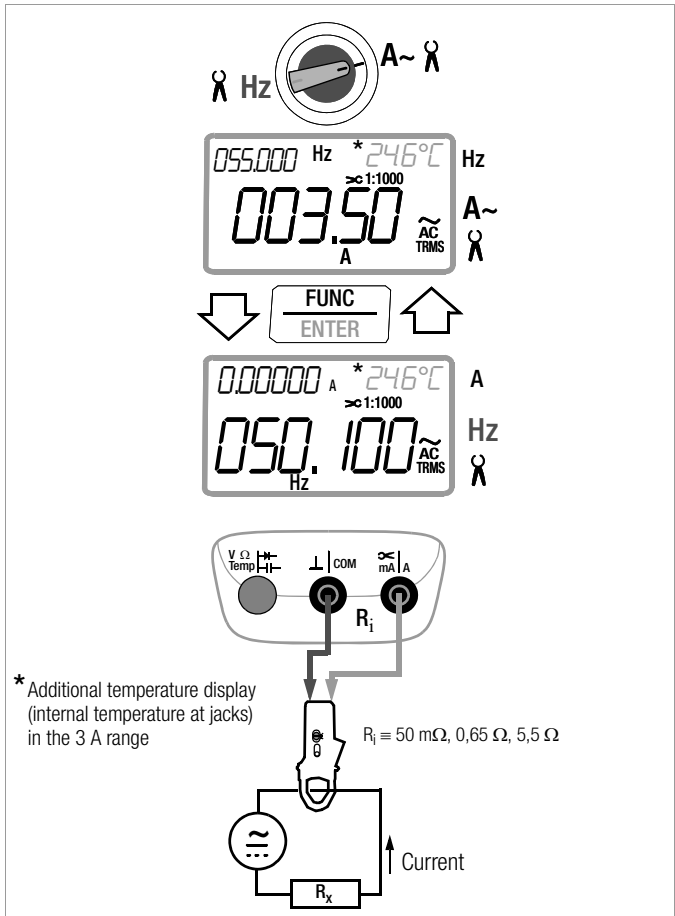

8 Device and Measuring Parameters

The instrument's "**SEL**" mode (menu mode) makes it possible to set operating and measuring parameters, query information and activate the interface.

- ⇨ The menu mode is accessed by pressing the **MEASURE | SETUP** key, assuming that the instrument is switched on and set to "Measure" (measuring mode operation). "**Info**" appears at the display.
- ⇨ By repeatedly pressing the $\triangleleft \triangleright \triangle \nabla$ key (in any direction), access is gained to the following main menus: "**StorE**", "**SEnd**" and "**SEL**", and the display is finally returned to "**Info**".
- ⇨ After selecting the desired main menu, the respective sub-menu is accessed by pressing the **FUNC | ENTER** key.
- ⇨ The desired parameter is selected by repeatedly pressing the $\triangle \nabla$ key.
- ⇨ In order to check or change a parameter, acknowledge it with the **FUNC | ENTER** key.
- ⇨ The $\triangleleft \triangleright$ keys can be used to position the cursor at the entry position. The desired value is selected with the help of the $\triangle \nabla$ keys.
- ⇨ Changes can only be applied with the **FUNC | ENTER** key.
- ⇨ After pressing the **ZERO | ESC** key, the display is returned to the submenu without making any changes, and by pressing the **ZERO | ESC** key once again, to the main menu etc.
- ⇨ You can switch to the measuring mode from any menu level by pressing the **MEASURE | SETUP** key.

After repeatedly pressing the **MEASURE | SETUP** key (without first turning the multimeter off), you can return to the last selected menu or parameter from the measuring mode.

Example: Setting Time

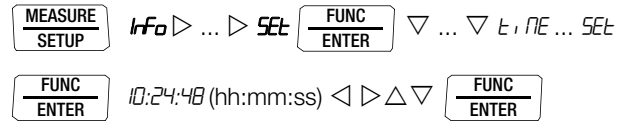

Setting hours and minutes:



Advance to desired entry position.



Change the setting, the entry position blinks.

Press and hold the key to change the setting rapidly.

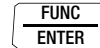

The new time setting is activated after acknowledgment.

8.1 Paths to the Various Parameters

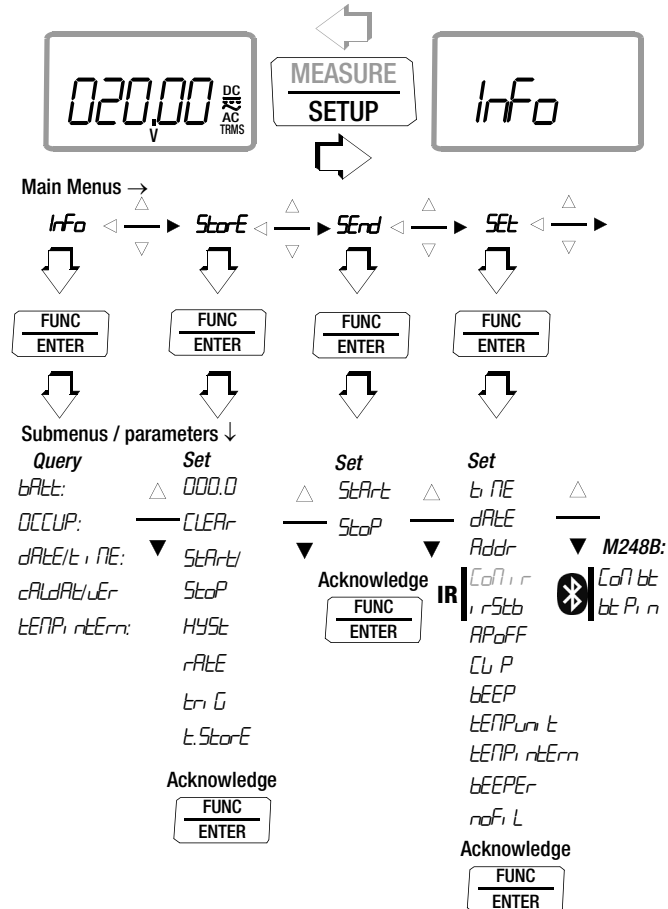

8.2 List of All Parameters

Parameter	Page: Header
<i>Addr</i>	55: Configuring Interface Parameters
<i>APoFF</i>	49: APoFF – Specified Time for Automatic Shutdown and Continuous ON
<i>bAtE</i>	48: bAtt – Query Battery Voltage
<i>bEEP</i>	50: bEEP – Set Limit Value for Continuity Testing
<i>bEEP_{on/oFF}</i>	50: bEEP _{on/oFF} – Activate/Deactivate Acoustic Signals
<i>bt P_{in}</i>	55: bt Pin – Allocating the pin for the Bluetooth interface (M248B)
<i>cALdAt</i>	48: cALdAt – Query Calibration Date
<i>CLEAR</i>	24: Measurement Data Recording
<i>Cl P</i>	43: Direct and Pulsating Current Measurement with Current Clamp Sensor, A DC and A (DC+AC)
<i>Co₁ bt</i>	55: Interface Selection for METRAHIT PM PRIME BT (M248B)
<i>Co₁ r</i>	55: Interface Selection for METRAHIT PM PRIME BT (M248B)
<i>dAtE</i>	48: dAtE – Query Date, 49: dAtE – Enter Date
<i>EMPTY</i>	24: Measurement Data Recording
<i>HYS</i>	51: HYS – Hysteresis (parameter for memory mode operation)
<i>Info</i>	48: Querying Parameters – Info Menu
<i>i rStb</i>	55: Configuring Interface Parameters
<i>tEMP</i>	48: tEMP intErn – Query Reference Temperature
<i>noFi L</i>	50: noFiL – quick display of measured values (as from firmwareversion 1.23)
<i>OCCUP</i>	24: Measurement Data Recording
<i>rAtE</i>	51: rAtE – Set Transmission and Storage Rate
<i>SEnd</i>	54: Activating the Interface
<i>SEt</i>	49: Entering Parameters – SETUP Menu
<i>StArT</i>	
<i>StOp</i>	24: Measurement Data Recording
<i>StorE</i>	
<i>tEMP, rAtErn</i>	48: tEMP intErn – Query Reference Temperature
<i>tEMP un t</i>	50: tEMP unit – Select a Unit of Measure for Temperature
<i>t, rAtE</i>	48: tIME – Query Time, 49: tIME – Set Time
<i>trIG</i>	52: trIG – Trigger Conditions (parameters for memory mode operation)
<i>tStorE</i>	52: tStorE – Recording Time (parameter for memory mode operation)
<i>vEr</i>	48: vErSion – Query Firmware Version

Device and Measuring Parameters

8.3 Querying Parameters – InFo Menu



bAtt – Query Battery Voltage

 *Info*  bAtt 2.9 V.

OCCUP – Query Memory Occupancy



 *Info*  bAtt ▾ ... ▾ OCCUP 000.0 %

dAtE – Query Date

 *Info*  bAtt ▾ ... ▾ 20.06. 20 12 (DD.MM. YY)
D = day, M = month, Y = year

Date and time must be reentered after replacing the batteries.

tiME – Query Time

 *Info*  bAtt ▾ ... ▾ 13:46:56 (hh:mm:ss)
h = hours, m = minutes, s = seconds

Date and time must be reentered after replacing the batteries.

cALdAt – Query Calibration Date

 *Info*  bAtt ▾ ... ▾ cALdAt 20.06. 12

vErSion – Query Firmware Version

 *Info*  bAtt ▾ ... ▾ vEr 0.22

ItEMP intErn – Query Reference Temperature

The temperature of the internal reference junction is measured with a temperature sensor in close proximity to the input sockets.

 *Info*  bAtt ▾ ... ▾ ItEMP, ntErn 24.7 °C

8.4 Entering Parameters – SETUP Menu

tiME – Set Time

Entering the correct time makes it possible to acquire measured values in real-time.

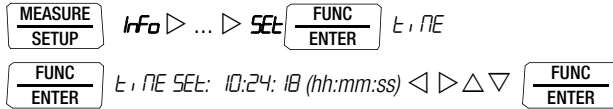

Date and time must be reentered after replacing the batteries.

dAtE – Enter Date

Entering the current date makes it possible to acquire measured values in real-time.

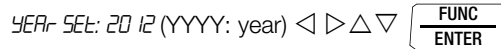
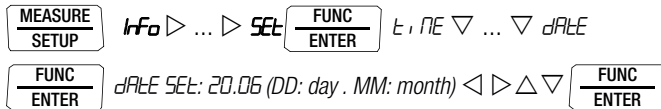

Date and time must be reentered after replacing the batteries.

Addr – Set Device Address

See section 9.3 on page 55.

irStb – Status of the Infrared Receiver in the Stand-By Mode

See section 9.3 on page 55 regarding settings.

CoM ir / CoM bt – Interface Operating System Infrared / Bluetooth

Refer to section 9.3 on page 55 for instructions on switching between the two systems.

bt pin – Pin for Bluetooth Interface

Refer to section 9.3 on page 55 on setting instructions.

APoFF – Specified Time for Automatic Shutdown and Continuous ON

The instrument is switched off automatically if the measured value remains unchanged for a long period of time and if none of the keys or the rotary switch have been activated before the specified time “APoFF” (entered in minutes) has elapsed.

If the **on** setting is selected, the multimeter is set to continuous operation and **on** appears in the display to the right of the battery symbol. In this case, the multimeter can only be switched off manually. The “**on**” setting can only be canceled by changing the respective parameter, or by switching the instrument off manually. In this case, the parameter is reset to 10 minutes.

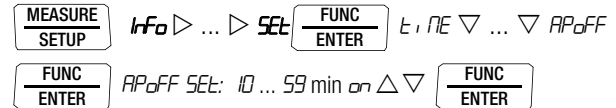

(10 minutes = default setting)

Note

The auto power off function (APoFF parameter) is deactivated when dangerous touch voltage is applied.

CLiP – Set Transformation Ratio (current clamp factor)

See section 7.7.3 ff.

bEEP – Set Limit Value for Continuity Testing

MEASURE SETUP *Info* ▷ ... ▷ SET FUNC ENTER *t, nE* ▽ ... ▽ *bEEP*
FUNC ENTER *bEEP SET: 1, 10, 20 ... 500 Ω* △ ▽ FUNC ENTER

(10 Ω = default setting)

tEMP unit – Select a Unit of Measure for Temperature

MEASURE SETUP *Info* ▷ ... ▷ SET FUNC ENTER *t, nE* ▽ ... ▽ *tEMP un t °C*
FUNC ENTER *un t SET: °C / °F* △ ▽ FUNC ENTER

(°C = default setting)

tEMP intErn/ExtErn – Select Internal or External Reference Junction External Reference Junction: Specified Temperature

MEASURE SETUP *Info* ▷ ... ▷ SET FUNC ENTER *t, nE* ▽ ... ▽ *tEMP, nErn*
FUNC ENTER *tEMP SET: tEMP, nErn / tENPE:tErn* △ ▽ FUNC ENTER
tErn SET: 0000 °C △ ▽ FUNC ENTER

(internal reference = default setting)

bEEPEr on/off – Activate/Deactivate Acoustic Signals

MEASURE SETUP *Info* ▷ ... ▷ SET FUNC ENTER *t, nE* ▽ ... ▽ *bEEPEr off*
FUNC ENTER *bEEPEr SET: on / off* △ ▽ FUNC ENTER

(bEEPEr on = default setting)

noFiL– quick display of measured values (as from firmwareversion 1.23)

For the following functions, a quicker display update rate of up to 5 display values per second (noFiL=ON) instead of 2 display values per second (noFiL=OFF) can be set: V DC, A DC with clamp, A DC direct, Ω, diode measurement.

MEASURE SETUP *Info* ▷ ... ▷ SET FUNC ENTER *rALe* ▽ ... ▽ *noFiL* FUNC ENTER
on / OFF △ ▽ FUNC ENTER (OFF = standard value*/default setting)

* All specifications refer to the default update rate with measuring parameter noFiL = OFF (default).

8.5 StorE Menu – Parameter for Memory Mode Operation

HYSt – Hysteresis (parameter for memory mode operation)

The hysteresis setting allows for efficient use of memory space. During memory mode operation, new measured data are only saved if they deviate from the previously stored value by an amount which exceeds the selected hysteresis value.

Hysteresis can be selected in steps from 1 to 10,000 digits. These digits are related to the measuring range as follows:

The position of the set digit in the specified hysteresis value corresponds to the same position within the measuring range, with counting being started at the right.

Example: A specified hysteresis of 01000 (highest place is in 4th position) for the 600.00 V measuring range means that only those measured values are saved to memory which deviate from the previous measured value by more than 10.00 V (4th position of the measuring range from the right).

Note

Due to the fact that the value is specified in digits (highest place all the way to the left), and thus depends on the measuring range, it's advisable to use the function with a fixed measuring range only.



rAtE – Set Transmission and Storage Rate

The sampling rate specifies the time interval after which the respective measured value is transmitted to the interface, or to measured value memory.

Any one of the following sampling rates can be selected:

[mm:ss.] 00:00.1, 00:00.2, 00:00.5, **00:01.0**, **00:02.0**, **00:05.0**
 [h:mm:ss.0] (h = hours, m = minutes, s = sec., 0 = tenths of a sec.)
 0:00:10, 0:00:20, 0:00:30, 0:00:40, 0:00:50, 0:01:00, 0:02:00, 0:05:00,
 0:10:00, 0:20:00, 0:30:00, 0:40:00, 0:50:00, 01:00:00, 02:00:00, 03:00:00,
04:00:00, **05:00:00**, **06:00:00**, **07:00:00**, **08:00:00**, **09:00:00**, **SAMPLE**, **dAtA**
(boldface: values or digits which are actually displayed, plain: placeholders for unit)

Setting the Sampling Rate

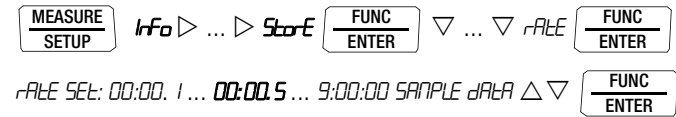

(00:00.5 = 0.5 s = default value)

The last selected value is retained, even after switching the instrument off.

If the selected **sampling rate is too short** for the measuring function, the smallest valid sampling rate is used automatically.

If a **sampling rate is selected which is greater than auto power off time** (see APoFF parameter on page 49), the instrument is switched off automatically after auto power off time has elapsed, and back on again roughly 10 seconds before the next measuring point.

Storage of Individual Values using the SAMPLE or dAtA Sampling Rate

If only manually selected values need to be saved, **SAMPLE** must be selected as the StorE > rAtE sampling value. If memory mode operation is then started, a single measured value is saved to permanent memory with time stamp when the **DATA/MIN/MAX** key is pressed and held until two rapidly repeating acoustic signals are generated.

If **dAtA** is selected as the StorE > rAtE sampling rate, and if memory mode operation is then started, measured values ascertained with activated DATA function are automatically saved to permanent memory with time stamp.

triG – Trigger Conditions (parameters for memory mode operation)

The StorE > triG SEt = Sto-ou / Sto-in / OFF setting can be used to specify how measured value recording is started and stopped:

- **triG = off:** Recording is started with Store > Start and ended with Store > Stop.
- **triG = sto-ou:** Recording is started as soon as a measured value occurs which is outside of the selected measuring limits, and is stopped as soon as the measuring limits are once again complied with, or the selected recording period has elapsed.
- **triG = sto-in:** Recording is started as soon as a measured value occurs which is within a specified band, and is stopped as soon as this is no longer the case, or after the maximum recording period has elapsed.

The band is specified with the help of the L_triG lower limit and the H_triG upper limit. Querying takes place in the event that triG OFF is selected. Bandwidths are specified in digits and defined by the measuring range limit, which, in the case of DC for example, corresponds to 300,000 (–300,000 to +300,000). In measuring functions with a small measuring range span (e.g.

V AC with 30,000 digits), it is not useful to set the trigger threshold above this measuring range span. It's thus advisable to perform measurement with a fixed measuring range. Due to the fact that rapid momentary value acquisition (see section 4.5.1) has a large measuring range span, limit values of greater than 30,000 digits can be selected.

Actual measurement is always executed using the sampling rate selected in “Store > rAtE”.

MEASURE SETUP Info ▷ ... ▷ StorE **FUNC ENTER** ▾ ... ▾ triG

FUNC ENTER triG SEt : Sto-ou / Sto-in / OFF ▾ ▾

FUNC ENTER L_triG SEt : - 150000 ... + 150000 ▾ ▾

FUNC ENTER H_triG SEt : - 150000 ... + 150000 ▾ ▾ **FUNC ENTER**

tStorE – Recording Time (parameter for memory mode operation)

This parameter determines whether or not measured values will be recorded for a limited time only. If recording time will be limited, its duration can be entered in hours, minutes and seconds. “∞” means unlimited recording time.

MEASURE SETUP Info ▷ ... ▷ StorE **FUNC ENTER** ▾ ... ▾ t.StorE

FUNC ENTER t.StorE SEt : ∞/99:00:00 (hh:mm:ss) ▾ ▾ **FUNC ENTER**

After completion of the recording time t.StorE, the end of the storage process is signalled by 2 short acoustic signals (as from firmware version V1.14).

8.6 Default Settings

Previously entered changes can be undone, and default settings can be restored. This may be advisable under the following circumstances:

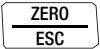
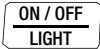
- After the occurrence of software or hardware errors
 - If you are under the impression that the multimeter does not work correctly
- ⇨ **Disconnect the device from the measuring circuit.**
- ⇨ Remove the batteries temporarily (see also section 11.2).
- ⇨ Simultaneously press and hold the  and  keys and reinsert the batteries at the same time, which is acknowledged with two acoustic signals.

9 Interface Operation

9.1 Arten von Schnittstellen und Anwendungszwecke

All instruments are equipped with an infrared interface which allows for data transfer to a PC. The interface adapter USB X-TRA, which is attached to the multimeter, (accessories see section 14 on page 70) is required for this purpose. It transforms the signal from infrared (multimeter) to USB (PC).

Analysis software METRAwin 10 can be used at the PC to transmit commands and parameters from the PC to the multimeter and to receive data. The following functions can be executed:

- Configure and read out measuring parameters
- Select a measuring function and a measuring range
- Start measurement
- Read out stored measured values

Instead of using METRAwin 10 software, it is also possible to use a terminal program.

As an alternative to the IR interface, model METRAHIT PM PRIME BT (M248B) features wireless connection to a PC via Bluetooth. METRAwin 10 software or a terminal program can be used with the Bluetooth interface analogous to the IR interface.

Additionally, METRAHIT PM PRIME BT (M248B) can be connected with Android devices (smartphone or a tablet) via the Bluetooth interface and be used in combination with the METRALOG smartphone app.

This section only describes the interface operation. Information regarding accessories (adapters, software) can be found in section 14.4.

9.2 Activating the Interface

The interface is automatically activated for receiving operation (multimeter receives data from the PC) as soon as the interface is addressed by the PC, assuming that the “*IrSltB*” parameter has been set to “*1, rOn*” (see section 9.3), or the instrument is already switched on (the first command wakes up the multimeter, but does not yet execute any further commands).

To activate the Bluetooth interface, set parameter “*CoPi r*” to “*CoPi B*” and allocate an access key (pin) via “*Bt P, n*”, see section 9.3. The Bluetooth interface is inactive when the multimeter is switched off.

The “continuous transmission” operating mode is selected manually as described below. In this operating mode, the instrument continuously transmits measurement data.

Starting Continuous Transmission Operation with Menu Functions

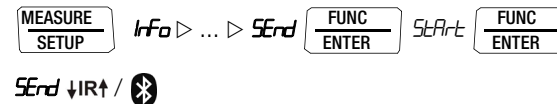

IR interface: IR and an arrow pointing to the right blink during transmission mode operation.

Bluetooth interface: During radio communication to the PC or smartphone, symbol  and the two cursors are flashing.

Stopping Continuous Transmission Operation with Menu Functions

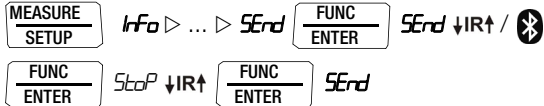

Automatic Activation and Deactivation of Transmission Mode Operation

If the sampling rate is 10 seconds or longer, the display is switched off automatically between samples in order to prolong battery service life. The only exception is when the multimeter is set to continuous operation. As soon as an event occurs, the display is automatically switched back on.

9.3 Configuring Interface Parameters

IRStb – Status of the Infrared Receiver in the Stand-by Mode

There are two possible switching statuses for the infrared interface when the multimeter is switched off (refers to METRAHIT PM PRIME (M248A) / for METRAHIT PM PRIME BT (M248B) CalIr must be set):

- iron: IR appears at the display and the infrared interface is active, i.e. signals such as making commands can be received, and power is consumed even though the multimeter is switched off.
- iroff: IR does not appear at the display and the infrared interface is switched off, signals cannot be received.

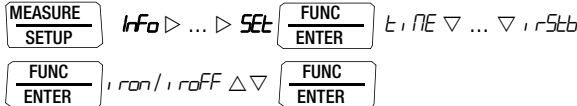

(irStb = iron = default setting, irStb = iroff = status upon delivery)

Interface Selection for METRAHIT PM PRIME BT (M248B)

- CalIr: Symbol IR for infrared is shown in the display, the infrared interface is selected and is either active or not active, depending on the parameter setting for irStb, see above. The Bluetooth interface is deactivated.
- Calbt: Symbol BT for Bluetooth is shown in the display, the Bluetooth interface is active. The infrared interface is deactivated.

Switching from IR to Bluetooth:



Switching from Bluetooth to IR:



bt Pin – Allocating the pin for the Bluetooth interface

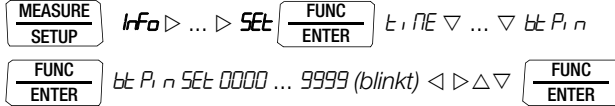

The pin entered at the multimeter must correspond to the pin at the PC or smartphone.



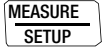

Interface Operation

Addr – Multimeter Address

If several multimeters are connected to the PC via an interface adapter, a separate address can be assigned to each instrument. Address number 1 should be selected for the first instrument, 2 should be assigned to the second and so forth.

 *Info* ▷ ... ▷ *SEt*  *t: ME* ▾ ... ▾ *Addr*

 *00* ... *01* ... *15* △ ▾ 

(15 = default setting)

10 Technical Data

Meas. Function	Measuring Range	Resolution at Upper Range Limit			Input impedance		Intrinsic Uncertainty under Reference Conditions			Overload Capacity ¹²	
		DC	AC/AC+DC				$\pm(\dots\% \text{rdgl} + \% \text{MR} + \dots \text{d})$	$\pm(\dots\% \text{rdgl} + \dots \text{d})$	$\pm(\dots\% \text{rdgl} + \dots \text{d})$	Value	Time
		309,999	30,999	3099	\equiv	\sim / \approx	\equiv	\sim	\approx^2		
V	300 mV	1 μ V	10 μ V		>10 M Ω	> 5 M Ω // < 50 pF	0.02 + 0.005 + 10 with ZERO	0.5 + 30 ²	0.5 + 30	600V DC AC RMS sine	Max. 10 sec.
	3 V	10 μ V	100 μ V		>10 M Ω	> 5 M Ω // < 50 pF	0.02 + 0.005 + 5	0.2 + 30 ¹	0.5 + 30		
	30 V	100 μ V	1 mV		>10 M Ω	> 5 M Ω // < 50 pF	0.02 + 0.005 + 5				
	300 V	1 mV	10 mV		>10 M Ω	> 5 M Ω // < 50 pF	0.02 + 0.005 + 5				
	600 V	10 mV	100 mV		>10 M Ω	> 5 M Ω // < 50 pF	0.02 + 0.005 + 5				
					Display Range for Reference Voltage U _{REF} = 0.775 V			Intrinsic Uncertainty			
dB	0.3 V / 3 V ... 600 V~			0.01 dB	-42 dB ... + 57 dB			0.1 dB (U > 10% MR)		600 V AC RMS sine	Cont.
		DC	AC/AC+DC		Voltage drop at approx. range limit		\equiv	\sim^2	\approx^2		
A	300 μ A	1 nA	10 nA		170 mV		0.05 + 0.02 + 5 with ZERO	0.5 + 30	0.5 + 30	0.7 A	Cont.
	3 mA	10 nA	100 nA		170 mV		0.05 + 0.01 + 5				
	30 mA	100 nA	1 μ A		170 mV		0.02 + 0.01 + 5				
	300 mA	1 μ A	10 μ A		200 mV		0.1 + 0.05 + 5				
	3 A	10 μ A	100 μ A		150 mV		0.2 + 0.05 + 5 with ZERO	0.7 + 30	0.7 + 30	10 A: \leq 5 min. ^{10,11} 16 A: \leq 30 s ¹¹	
	10 A	100 μ A	1 mA		470 mV		0.2 + 0.05 + 5	0.5 + 30	0.5 + 30		
	Factor: 1:1/10/100/1000		Input		Input impedance						
A \succ C	0.03, 0.3, 3, 30 A		30 mA		Current measurement input (\AA Socket)		See current measuring ranges for specification. Plus current transformer clamp error			Measurement input 0.7 A cont. 3 A: 5 min.	
	0.3, 3, 30, 300 A		300 mA								
	3/30/300/3000 A		3 A								
A \succ C	0.3, 3, 30, 300 A 3/30/300/3000 A		300 mV 3 V / 30 V		Voltage measurement input (V jack) Ri = 5 M Ω /10 M Ω		See voltage measuring ranges for specification.			Measurement input 600 V TRMS	
					Open-circuit voltage	Measuring current at range limit	$\pm(\dots\% \text{rdgl} + \% \text{MR} \dots \text{d})$				
Ω	300 Ω	1 m Ω			< 2 V	Approx. 0.5 mA	0.05 + 0.01 + 5 with ZERO	600 V DC AC RMS sine	Max. 10 sec. (PTC)		
	3 k Ω	10 m Ω			< 2 V	Approx. 130 μ A	0.05 + 0.01 + 5 with ZERO				
	30 k Ω	100 m Ω			< 2 V	Approx. 20 μ A	0.05 + 0.01 + 5				
	300 k Ω	1 Ω			< 2 V	Approx. 2 μ A	0.05 + 0.01 + 5				
	3 M Ω	10 Ω			< 2 V	Approx. 1 μ A	0.1 + 0.02 + 5				
	30 M Ω	100 Ω			< 2 V	Approx. 200 nA	1 + 0.2 + 5				
\AA)	300 Ω	—	0.1 Ω		< 4.5 V	Approx. 1 mA const.	1 + 5 with ZERO		600 V	Max. 10 sec.	
\AA +	4,5 V ³	—	1mV		< 6 V	Approx. 1 mA const.	0.2 + 3		600 V	Max. 10 sec.	

Technical Data

Meas. Function	Measuring Range		Resolution at Upper Range Limit			Conditions		Intrinsic Uncertainty under Reference Conditions			Overload Capacity ^{1,2}	
			309,999	30,999	3099						Value	Time
F	3 nF	—	—	1 pF	Discharge resist. 1 MΩ	U _{0 max} 2 V	±(... % rdg. + ... d) ⁴			600 V DC AC RMS sine	Max. 10 s	
	30 nF	—	—	10 pF			1 MΩ	2 V	2 + 15 with ZERO function active			
	300 nF	—	—	100 pF	100 kΩ	2 V	1 + 6 with ZERO function active					
	3 μF	—	—	1 nF	100 kΩ	2 V	1 + 6					
	30 μF	—	—	10 nF	10 kΩ	2 V						
	300 μF	—	—	100 nF		2 V						
	3 mF	—	—	1 μF	2.5 kΩ	2 V	5 + 6					
Hz (V)	300 Hz	0.001 Hz				f _{min} ⁵	±(... % rdg. + ... d)			Hz (V) ⁶ : Hz(A) ⁶ : 600 V Hz (A): ⁷	Max. 10 s	
Hz (A)	3 kHz	0.01 Hz				5 Hz	Hz(V) 0.05 + 2 ⁸ Hz(A) 0.05 + 3 ⁸					
Hz (A>C)	30 kHz	0.1 Hz				10 Hz						
Hz (V)	300 kHz	1 Hz				1 Hz	0.05 + 2 Level High 3 V ... 5 V unipolar signal					
MHz	300 Hz	0.001 Hz					absolute intrinsic uncertainty			600 V	max. 10 s	
	3 kHz	0.01 Hz					± 0.2 % Level High 3 V ... 5 V uni- or bipolar signal					
	30 kHz	0.1 Hz					± (0.1 % + 0.10 % / kHz) Level High 3 V ... 5 V unipolar signal					
	300 kHz	1 Hz					± (0.1 % + 0.15 % / kHz) Level High 3 V ... 5 V bipolar signal					
%	2.00 ... 98.00%		—	0.01 %	15 Hz ... 1 kHz		absolute intrinsic uncertainty			600 V	Max. 10 s	
	5.00 ... 95.00%			0.01%	1 kHz ... 10 kHz		± (0.1 % + 0.10 % / kHz) Level High 3 V ... 5 V unipolar signal					
°C/°F	Pt100	-200.0 ... +100.0 °C					±(... % rdg. + ... d)			600 V DC/AC RMS sine	Max. 10 s	
	Pt1000	+100.0 ... +850.0 °C	0.1	K			0.3 + 10 ⁹					
	K (NiCr-Ni)	-250.0 ... +1372.0 °C						1% + 2.0 K ⁹				
	intern. temperature measurement.	-10 ... +80 °C	0.1	K		Auxiliary display in ampere range	±2 K					

¹ Specified accuracy valid as of 1% of the measuring range

² Specified accuracy valid as of 2% of the measuring range

³ Display of up to max. 4.5 V, above which overload display appears: "OL"

⁴ Applies to measurements at film capacitors and during battery operation

⁵ Lowest measurable frequency for sinusoidal measuring signals symmetrical to the zero point

⁶ Overload capacity of the voltage measurement input:

power limiting: frequency × voltage max. $3 \times 10^6 \text{ V} \times \text{Hz}$ for U > 100 V

⁷ Overload capacity of the current measurement input: see current measuring ranges for max. current values

⁸ Input sensitivity, sinusoidal signal: 10% to 100% of voltage/current measuring range;

in the 300 kHz range the specified intrinsic uncertainty applies as from 15% of measuring range

⁹ Plus sensor deviation

¹⁰ As of a measured value of 7 A, measurement is limited to an ambient temperature of 30 °C or a maximum duration of 5 minutes.

¹¹ Off-time > 30 min. and T_A ≤ 40 °C after a 10 A or 16 A measurement

¹² At 0 ° ... + 40 °C

Key: d = digit(s), MR = measuring range, rdg. = reading (measured value)

Influencing Quantities and Influence Error

Influencing Quantity	Sphere of Influence	Measured Quantity / Measuring Range ¹	Influence Error (1...% rdg.l + ... d) / 10 K
Temperature	0° C ... +21° C and +25° C ... +40° C	V $\overline{\text{---}}$	0.05 + 5
		V~, V $\overline{\text{---}}$, dB	0.2 + 10
		300 Ω ... 30 M Ω , $\overline{\text{---}}$)	0.1 + 10
		A $\overline{\text{---}}$, A~, A $\overline{\text{---}}$	0.3 + 10
		30 nF, 300 nF, 3 μ F, 30 μ F	0.5 + 10
		3 nF, 300 μ F	3 + 10
		Hz	0.05 + 5
		$\overline{\text{---}}$	0.1 + 5
		°C/°F (Pt100/Pt1000)	0.1 + 10
		°C/°F thermocouple K ²	0.1 + 10

¹ With zero balancing

² Prerequisite: stable ambient temperature (t > 30 min.)

Influencing Quantity	Measured Quantity	Influence Error (1...% rdg.l + ... d)
DATA	V, A, Ω , Hz, dB, °C	± 10 d
MIN / MAX	V, A, Ω , Hz, dB, °C	± 30 d

Influencing Quantity	Measured Quantity / Measuring Range	Sphere of Influence	Intrinsic Uncertainty \pm (1... % rdg.l + ... d) ¹
Frequency	V _{AC} V _{AC+DC}	> 15 Hz ... 45 Hz	2 + 30
		300.00 mV ... > 65 Hz ... 1 kHz	0.5 + 30
		30.000 V ³	2 + 30
		> 1 kHz ... 20 kHz	3 + 30 ²
	300.00 V ³ 600.00 V ³	> 15 Hz ... 45 Hz	2 + 30
		> 65 Hz ... 5 kHz	2 + 30
		> 5kHz ... 20 kHz	3 + 30
		> 15 Hz ... 45 Hz	3 + 30 ⁴
	> 65 Hz ... 10 kHz		
	I _{AC} I _{AC+DC}	300 μ A ... 10 A	> 15 Hz ... 45 Hz
		> 65 Hz ... 10 kHz	

¹ Intrinsic uncertainty in the frequency response applies as of 10% ... 100% of the measuring range.

² Signals > 50 kHz: plus 5%

³ Power limiting: frequency \times voltage max. 3×10^6 V \times Hz where U > 100 V

⁴ the following applies for the 300 μ A measuring range: 7 + 30

Influencing Quantity	Sphere of Influence	Measured Quantity / Measuring Range	Influence Error ⁵
Crest Factor CF	1 ... 3	V~, A~	$\pm 1\%$ rdg.l
	> 3 ... 5		$\pm 3\%$ rdg.l

⁵ Except for sinusoidal waveform

Influencing Quantity	Sphere of Influence	Measured Quantity	Influence Error
Relative Humidity	75%	V, A, Ω , F, Hz, dB, °C	1 \times intrinsic error
	3 days		
	instrument off		
Battery voltage	Range: 2.0 ... 3.6 V	ditto	Included in intrinsic error

Influencing Quantity	Sphere of Influence	Meas. Quantity / Measuring Range	Damping
Common Mode Interference Voltage	Interference quantity: max. 600 V~	V \equiv (3 V ... 600 V MR)	> 120 dB
	Interference quantity: max. 600 V~ 50 Hz ... 60 Hz, sine	3 V ~	> 60 dB
		30 V ~	> 65 dB
Series Mode Interference Voltage	Interference quantity: V ~, respective nominal value of the measuring range, max. 600 V ~, 50 Hz ... 60 Hz sinusoidal	V \equiv	> 70 dB
		300 V/600 V ~	> 50 dB
	Interference quantity: max. 600 V —	V ~	> 120 dB

Reference Conditions

Ambient temperature	+23 °C \pm 2 K
Relative humidity	40 ... 75%, no condensation allowed
Meas. quantity frequency	Range: 45 ... 65 Hz
Meas. quantity waveform	Sinusoidal
Battery voltage	Range: 2.0 ... 3.2 V

Response Time (after manual range selection)

Measured Quantity / Measuring Range	Response Time, Digital Display	Jump Function of the Measured Quantity
V \equiv , V~, dB A \equiv , A~	1.5 s	From 0 to 80% of upper range limit value
3 nF ... 300 μ F	Max. 3 s	
300 Ω ... 3 M Ω	3 s	From ∞ to 50% of upper range limit value
30 M Ω	8 s	
Continuity	< 50 ms	
°C (Pt100)	Max. 3 s	
	1.5 s	

Measured Quantity / Measuring Range	Response Time, Digital Display	Jump Function of the Measured Quantity
>10 Hz	1.5 s	From 0 to 50% of upper range limit value

Internal clock

Time format	DD.MM.YYYY hh:mm:ss,0
Resolution	0.1 sec.
Accuracy	\pm 1 minute per month
Temperature influence	50 ppm/K

Data Interface – Infrared

Type	Optical via infrared light through the housing
Data transmission	Serial, bidirectional (not IrDa compatible)
Protocol	Device specific
Baud rate	38,400 baud
Functions	<ul style="list-style-type: none"> – Select/query measuring functions and parameters – Query/transmit momentary measurement data – Read out stored measurement data

The USB X-TRA plug-in interface adapter (see section 14 on page 70) is used for adaptation to the PC's USB port.

Data Interface – Bluetooth (M248B only)

The METRAHIT PM PRIME BT Bluetooth multimeter variant (M248B) is identical to the METRAHIT PM PRIME (M248A), except that it is also equipped with a Bluetooth interface.

Bluetooth version 2.1 + EDR,
 Frequency range 2.4 ... 2.4835 GHz
 Transmission intensity max. 2.5 mW (Class 2)
 Transmission range approx. 20 m (depending on propagation conditions)

Wireless data exchange via Bluetooth is an alternative to the optional IR-USB cable connection using the USB X-TRA accessory (Z216C).

The instrument is connected directly to the Bluetooth interface of a Windows PC or smartphone (Android). However, no communication takes place with peripheral devices such as printers, scanners and the like.

Remote control via Bluetooth is identical to corresponding communication via an IR-USB connection.

The only prerequisite for wireless data exchange between multimeter and PC or smartphone (Android) is switching from Infrared to Bluetooth and authentication by means of an access code which must be set at the multimeter and at the PC or smartphone, see section 9.3.

Information on the smartphone app **METRALOG** is available in section 14.4.

Internal Measured Value Storage

Memory capacity 16 MBit (2 MByte) for approx. 300,000 measured values with time stamp

Power Supply

Battery 2 ea. 1.5 V mignon cell (size AA), alkaline manganese per IEC LR6 (2 ea. 1.2 V NiMH rechargeable battery also possible)

Service life With alkaline manganese: approx. 200 hrs. METRAHIT PM PRIME BT: When the Bluetooth interface is activated, power consumption rises considerably and the service life is reduced accordingly.

Battery test Battery capacity display with battery symbol in 4 segments: . Querying of momentary battery voltage via menu function.

Power OFF function The multimeter is switched off automatically:
 – If battery voltage drops to below approx. 2.0 V
 – If none of the keys or the rotary switch are activated for an adjustable duration (10 to 59 min.) and the multimeter is not in the continuous operation mode

Power pack socket If the NA X-TRA power pack has been plugged into the instrument (see accessories), the installed batteries are disconnected automatically. Rechargeable batteries can only be recharged externally.

Display

Transreflective LCD panel (65 × 36 mm) with display of up to 3 measured values, unit of measure, type of current and various special functions.



Background Illumination

Background illumination is switched off approximately 1 minute after it has been activated.

Digital

Display / Char. Height	7-segment characters, main display: 13 mm, auxiliary display: 7.5 mm
Number of places	309,999 steps
Overflow display	"OL" is displayed for $\geq 310,000 + 1$ digit
Polarity display	"-" (minus sign) is displayed if plus pole is connected to "1"
Measuring rate	10 measurements per second, 40 measurements per second with Min-Max function except with capacitance, frequency and duty cycle measuring functions
Refresh Rate	2 times per second, every 500 ms (Standard*: noFIL=OFF) 5 ×/s (Parameter noFIL=on)

* All specifications refer to the default update rate with measuring parameter noFIL = OFF (default).

Acoustic Signals

For voltage

which exceeds 600 V in the 600 V range:
intermittent signal (250 ms on, 250 ms off)

For current

which exceeds 10 A: intermittent signal
which exceeds 16 A: continuous
– For displayed temperature > 50 °C

Fuse

Fuse link

FF (UR) 10 A/1000 V AC/DC,
10 × 38 mm,
breaking capacity: 30 kA at 1000 V AC/DC,
protects the current input socket in the
300 μA to 10 A ranges

Electrical Safety

Protection class	II	
Measuring category	CAT III	CAT IV
Operating voltage	600 V	300 V
Pollution degree	2	
Test Voltage	5.2 kV~	

Electromagnetic Compatibility (EMC)

Interference emission EN 61326-1, class B
 Interference immunity EN 61326-1
 EN 61326-2-1

Protection

Housing: IP 52
 (Protection against foreign object entry: protected against dust in harmful quantities; protection against the penetration by water: protection against dripping water when the housing is tilted at an angle of up to 15°) (pressure equalization via the housing)

Ambient Conditions

Accuracy range 0 °C to +40 °C
 Operating temp. range T_A -10 °C ... +50 °C *
 Storage temp. range -25 °C ... +70 °C (without batteries)
 Relative humidity Max. 75%, no condensation allowed
 Elevation To 2000 m
 Deployment Indoors, except within specified ambient conditions

* Exception: current > 10 A to 16 A, operation at up to 40 °C

Sockets: IP20
 (Protection against foreign object entry: protected against solid foreign objects with a diameter of ≥ 12.5 mm; protection against the penetration by water: protection against dripping water when the housing is tilted at an angle of up to 15°)

Mechanical Design

Housing Impact resistant plastic (ABS)
 Dimensions 200 × 87 × 45 mm
 (without rubber holster)
 Weight Approx. 0.4 kg with batteries

11 Maintenance and Calibration

11.1 Displays – Error Messages

Message	Function	Meaning
FUSE	Current measurement	Blown fuse
	In all operating modes	Battery voltage has fallen below 2.0 V
OL	Measuring	Indicates overflow

11.2 Batteries

The instrument requires two 1.5 V batteries in accordance with IEC R 6 or IEC LR 6, or two equivalent rechargeable NiMH batteries.

 **Note**
Rechargeable batteries must be charged externally.

 **Note**
Removing the (Rechargeable) Batteries During Periods of Non-Use
The integrated quartz movement draws power from the batteries even when the instrument is switched off. It's advisable to remove the batteries during long periods of non-use for this reason (e.g. vacation). This prevents excessive depletion of the batteries, which may result in damage under unfavorable conditions.

Charge Level

The current battery charge level can be queried in the “rfo” menu:

 **Info**  **bAtt: 2.75 V.**

If the “” symbol appears at the display, the batteries should be replaced as soon as possible. You can continue working with the instrument, but reduced measuring accuracy may result.

Replacing the (Rechargeable) Batteries

 **Attention!**
Switch off and disconnect the instrument from the measuring circuit before opening the battery compartment lid in order to replace the batteries.

 **Note**
Stored measurement data are not lost when the batteries are replaced. The selected operating parameters remain in memory, although date and time must be reentered.

- Set the instrument face down onto the working surface.
- Turn the slotted screw on the lid with the battery symbols counterclockwise.
- Lift off the lid and remove the batteries from the battery compartment.
- Insert two new appropriate batteries or rechargeable batteries (see „Technical Data“ on page 57) into the battery compartment, making sure that the plus and minus poles match up with the provided polarity symbols.
- When replacing the battery compartment lid, insert the side with the guide hooks first. Tighten the screw by turning it clockwise.
- Dispose of depleted batteries in accordance with environmental protection regulations, see „Disposal and Environmental Protection“ on page 68.

11.3 Fuse

The fuse is tested automatically:

- When the instrument is switched on with the rotary switch in the A position
- When the instrument is already on and the rotary switch is turned to the A position
- In the active current measuring range when voltage is applied

If the fuse is blown or has not been inserted, "FuSE" appears at the digital display. The fuse interrupts the current measuring ranges. All other measuring ranges remain functional.



Replacing the Fuse



Attention!

If a fuse should blow, eliminate the cause of overload before placing the instrument back into service!



Attention!

Switch off and disconnect the instrument from the measuring circuit before opening the fuse cover in order to replace the fuse!

- ⇨ Set the instrument face down onto the working surface.
- ⇨ Turn the slotted screw on the cover with the fuse symbol counterclockwise.

- ⇨ Lift off the cover and pry the fuse out using the flat side of the fuse cover.
- ⇨ Insert a new appropriate fuse (see „Technical Data“ on page 57). Make sure that the fuse is centered, i.e. between the tabs at the sides.



Attention!

Use specified fuses only!

If fuses with other blowing characteristics, other current ratings or other breaking capacities are used, the operator is placed in danger, and protective diodes, resistors and other components may be damaged.

The use of repaired fuses or short-circuiting the fuse holder is prohibited.

- ⇨ When replacing the fuse cover, insert the side with the guide hooks first. Tighten the screw by turning it clockwise.
- ⇨ Dispose of the blown fuse in accordance with environmental protection regulations, see „Disposal and Environmental Protection“ on page 68.

11.4 Cleaning

No special maintenance is required for the housing. Keep outside surfaces clean.



Attention!
Life endangering due to electric shock!

The instrument, the accessories and all connected conductors must be voltage-free before and during cleaning.

Switch the instrument off.

Never immerse the instrument/accessories in water or other fluids.

Never touch the instrument/accessories with wet or moist hands.



Attention!
Unsuitable Cleaning Agents

Unsuitable cleaning agents such as aggressive or abrasive cleansers result in damage to the instrument/accessories.

Use a cloth for cleaning, which has been slightly dampened with water. Avoid the use of cleansers, abrasives or solvents.

11.5 Recalibration

The measuring tasks performed with your instrument, and the stressing it's subjected to, influence aging of its components and may result in deviation from the specified levels of accuracy.

In the case of strict measuring accuracy requirements, as well as as well as severe stressing (e.g. severe climatic or mechanical stress) we recommend a relatively short calibration interval of one year. If this is not the case, a calibration interval of 2 to 3 years is sufficient as a rule.

Please contact GMC-I Service GmbH for calibration services, see „Contact, Support and Service“ on page 3.



Note

Date on Calibration Certificate / Calibration Interval Begins Upon Receipt

Your instrument is furnished with a calibration certificate on which a date appears. This date may be further in the past if your instrument has been stored for some time prior to sale. The instruments are stored in accordance with the specified conditions. Drift is thus negligible for a duration of 1 year and longer storage periods are highly unusual.

Consequently, the instrument's characteristic values lie within the specifications and the first calibration interval can be determined as of the date of receipt.

12 Repair

If your instrument requires repair, please contact our service department. See „Contact, Support and Service“ on page 3.

**Attention!****Loss of warranty and guarantee claims**

Unauthorized modification of the instrument is prohibited. This also includes opening of the device. If it can be ascertained that the instrument has been opened by unauthorized personnel, no guarantee claims can be honored by the manufacturer with regard to personal safety, measuring accuracy, compliance with applicable safety measures or any consequential damages.

If the guarantee seal is damaged or removed, all guarantee claims are rendered null and void.

**Attention!**

The device may only be repaired or opened by authorized, qualified personnel who are familiar with the associated dangers.

Original replacement parts may only be installed by authorized, qualified personnel.

**Attention!**

When the instrument is opened, voltage conducting parts may be exposed. The instrument must be disconnected from the measuring circuit before performing repairs or replacing parts. If repair of a live, open instrument is required, it may only be carried out by trained personnel who are familiar with the dangers involved.

**Note****Data Protection**

Data can be stored in the instrument.

Back up your data before sending the instrument for repair.

13 Disposal and Environmental Protection

Proper disposal makes an important contribution to the protection of our environment and the conservation of natural resources.



Attention!

Environmental Damage

Improper disposal results in environmental damage. Follow the instructions concerning return and disposal included in this section.

The following comments refer specifically to the legal situation in the Federal Republic of Germany. Owners or end users who are subject to other national requirements are required to comply with the respectively applicable national requirements and to implement them correctly on site. Relevant information can be obtained for example, from the responsible national authorities or national distributors.

Waste Electrical Equipment, Electrical or Electronic Accessories and Waste Batteries (including rechargeable batteries)

Electrical equipment and batteries (including rechargeable batteries) contain valuable raw materials that can be recycled, as well as hazardous substances which can cause serious harm to human health and the environment, and they must be recycled and disposed of correctly.



The symbol on the left depicting a crossed-out garbage can on wheels refers to the legal obligation of the owner or end user (German electrical and electronic equipment act ElektroG and German battery act BattG) not to dispose of used electrical equipment and batteries with unsorted municipal waste (“household trash”). Waste batteries must be removed from the old device (where possible) without destroying

them and the old device and the waste batteries must be disposed of separately. The battery type and its chemical composition are indicated on the battery’s labelling. If the abbreviations “Pb” for lead, “Cd” for cadmium or “Hg” for mercury are included, the battery exceeds the limit for the respective metal.

Please observe the owner’s or end user’s responsibility with regard to deleting personal data, as well as any other sensitive data, from old devices before disposal.

Old devices, electrical or electronic accessories and waste batteries (including rechargeable batteries) used in Germany can be returned free of charge to Gossen Metrawatt GmbH or the service provider responsible for their disposal in compliance with applicable regulations, in particular laws concerning packaging and hazardous goods. Further information regarding returns can be found on our website.

Packaging Materials

We recommend retaining the respective packaging materials for the case that you might require servicing or calibration in the future.



Attention!

Danger of Asphyxiation Resulting from Foils and Other Packaging Materials

Children and other vulnerable persons may suffocate if they wrap themselves in packaging materials, or their components or foils, or if they pull them over their heads or swallow them.

Keep packaging materials, as well as their components and foils, out of the reach of babies, children and other vulnerable persons.

In accordance with German packaging law (VerpackG), the user is obligated to correctly dispose of packaging and its components separately, and not together with unsorted municipal waste ("household trash").

Private end consumers can dispose of packaging free of charge at the responsible collection point. Packaging which is not subject to so-called system participation is returned to the appointed service provider. Further information regarding returns can be found on our website.

14 Accessories

14.1 General

The extensive accessories available for our measuring instruments are checked for compliance with currently valid safety regulations at regular intervals, and are expanded as required for new applications. Currently up-to-date accessories which are suitable for your measuring instrument are listed at the following web address along with photo, order number, description and, depending upon the scope of the respective accessory, data sheet and operating instructions: www.gossenmetrawatt.de.

14.2 Technical Data for Measurement Cables (scope of delivery: KS17-2 safety cable set)

Electrical Safety

Maximum rated voltage	600 V	1000 V	1000 V
Measuring category	CAT IV	CAT III	CAT II
Max. rated current:	1 A	1 A	16 A
With safety cap attached	•	•	—
Without safety cap	—	—	•

Observe the measuring instrument's maximum values for electrical safety.

Ambient Conditions (EN 61 010-031)

Temperature	-20 °C ... + 50 °C
Relative humidity	Max. 80%
Pollution degree	2

Using the KS17-2 Cable Set



Attention!

Measurements per DIN EN 61010-031 may only be performed in environments in accordance with measuring categories III and IV with the safety cap attached to the test probe at the end of the measurement cable.

In order to establish contact inside 4 mm jacks, the safety caps have to be removed by prying open the snap fastener with a pointed object (e.g. the other test probe).

14.3 NA X-TRA Power Pack (not included)

Use power packs from Gossen Metrawatt GmbH only in combination with your instrument. This assures operator safety by means of an extremely well insulated cable, and safe electrical isolation (nominal secondary ratings: 5 V / 600 mA). Installed batteries are disconnected electronically if the power pack is used, and need not be removed from the instrument.



Note

Use of the power pack may result in significant deviations for the following measuring functions on account of capacitive coupling:
mV AC, μ A AC and capacitance measurement.
We recommend battery operation in this case.
The specified technical data only apply for battery operation.

14.4 Interface Accessories (not included)

USB X-TRA Bidirectional Interface Adapter for IR Interface (Z216C)

This adapter is used to connect METRAHIT PM PRIME and METRAHIT PM PRIME BT via their serial IR interface with the USB port of a PC. The adapter then allows for data transmission between the multimeter and the PC. The METRAwin 10 PC software or a terminal program (see below) is required for the evaluation of measurement data.

The adapter can also be used for other multimeters by Gossen Metrawatt GmbH. Information on compatible instruments can be found on our website.

Please refer to the associated datasheet for information regarding the order. Information on use can be found in the product documentation of USB X-TRA as well as in Kap. 9 auf Seite 54.

METRAwin 10 PC Analysis Software (GTZ3240000R0001)

METRAwin 10 PC software is a multilingual measurement data logging program for time-related recording, visualizing, evaluating and documenting measured values from METRAHIT PM PRIME and METRAHIT PM PRIME BT multimeters. The USB X-TRA interface adapter is required for transferring data to a PC (see above).

The software can also be used with other multimeters by Gossen Metrawatt GmbH. Information on compatible instruments can be found on our website.

A 30 days test version can be downloaded from our website. Please refer to the associated datasheet for information regarding the order.

Information on installation and use can be found in the product documentation of METRAwin 10.

Terminal Program for PC

As an alternative to the METRAwin 10 software, you can use a terminal program for displaying and evaluating the data transmitted via IR or Bluetooth connection and for remote control of the instruments.

The interface description is available upon request.

Please note that we do not provide any support for the use of a terminal program.

METRALOG App for Smartphone and Tablet PC

If you use a smartphone or a tablet PC with the Android operating system and a Bluetooth interface, our METRALOG app provides the following functions in combination with the METRAHIT PM PRIME BT:

- Display of received multimeter measured values as: Digital or analog values, measured value curve $Y(t)$, measured value logger
- Recording of measuring operations
- Transmission of logs via wireless services and network services
- Acoustic warning in the event that wireless connection is interrupted
- Trigger in the event of exceeding or falling short of an adjustable limit value
- Acoustic warning if a trigger event should occur

The METRALOG app can be obtained from the Google Play Store (see QR code to the right) and installed to your smartphone or tablet PC (operating systems as of Android 7.1).



**Attention!**

Any and all liability is excluded for possible software errors, in particular also resulting from interaction with other applications.

Information on installation and use can be found in the product documentation of the app.

15 CE Declaration

This instrument fulfills all requirements of applicable EU directives and national regulations. We confirm this with the CE mark.

Gossen Metrawatt GmbH	Begleitende Formulare zum PEP EU-Konformitätserklärung / EU Declaration of Conformity	Form E0F34
------------------------------	-------------------------------------------------------------------------------------------------	-------------------

Hersteller / Manufacturer: Gossen Metrawatt GmbH
 Anschrift / Address: Südwestpark 15, 90449 Nürnberg
 Produktbezeichnung/ Hochauflösendes TRMS Digitalmultimeter
 Product name: High resolution digital multimeter
 Typ / Type: METRAHIT PM PRIME / PM PRIME BT / ULTRA
 Bestell-Nr / Order No: M246A / B / R
 Zubehör / Accessories: Kabelset / Cable set KS17-2

Der oben beschriebene Gegenstand der Erklärung* erfüllt die einschlägigen Harmonisierungsvorschriften der Union: / The object of the declaration** described above is in conformity with the relevant Union harmonisation legislation:

2014/53/EU	Funkanlagen - Richtlinie	Radio Equipment Directive
------------	--------------------------	---------------------------

Anforderungen an die Sicherheit gemäß 2014/35/EU (Niederspannungsrichtlinie) / Safety requirements according to 2014/35/EU (Low Voltage Directive)

EN/Norm/Standard:

EN 61010-1 : 2010 + A1 : 2019 + A1 : 2019/AC : 2019, EN 61010-2-033 : 2012, EN 61010-031 : 2015

Anforderungen an die elektromagnetische Verträglichkeit gemäß 2014/30/EU (EMV Richtlinie) / Requirements for electromagnetic compatibility according to 2014/30/EU (EMC Directive)

EN/Norm/Standard:

EN 61326-1 : 2013

2011/65/EU	RoHS - Richtlinie	RoHS Directive
(EU) 2015/863	Delegierte Richtlinie	Delegiate Directive

EN/Norm/Standard:

EN IEC 63000 : 2018

Nürnberg, 23.05.2023
 Ort, Datum / Place, Date:

 Marcel Hütko, Geschäftsführer / Managing Director

*) Die alleinige Verantwortung für die Ausstellung dieser Konformitätserklärung trägt der Hersteller, die beim Hersteller selbst oder bei der Fertigung von Eigentümern. Die Dokumentationsmerkmale der mitgelieferten Produktkennzeichnungen sind zu beachten.

***) This Declaration of Conformity is issued under the sole responsibility of the manufacturer but does not include a property assurance. The safety notes given in the product documentation which are part of the supply, must be observed.

Date:	Ausgabe:	Erstellt:	Freigabe:
23-1-M246X-CE-Entwurf	15.01.2021	Eckl	Weiß

© Gossen Metrawatt GmbH

Edited in Germany • Subject to change without notice / Errors excepted • A pdf version is available on the Internet

All trademarks, registered trademarks, logos, product names, and company names are the property of their respective owners.

 **GOSSEN METRAWATT**
Gossen Metrawatt GmbH
Südwestpark 15
90449 Nürnberg • Germany

Phone: +49-911-8602-0
Fax: +49-911-8602-669
e-mail: info@gossenmetrawatt.com
www.gossenmetrawatt.com