

# METRALINE DM 61/62

## Analog-Digital Multimeter

3-447-013-03

4/3.21



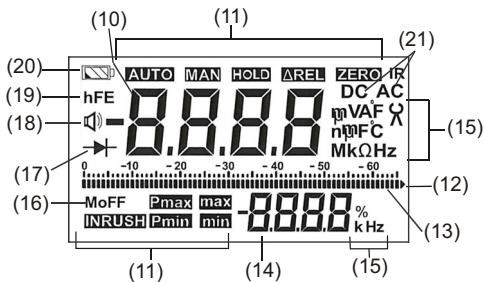
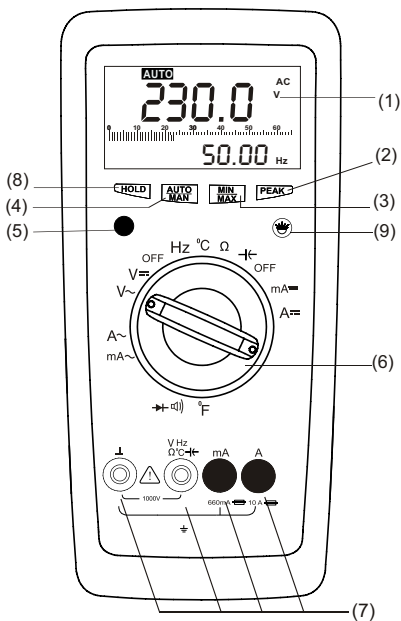

- 1 Liquid crystal display
- 2 P<sub>MAX</sub> / P<sub>MIN</sub> pushbutton
- 3 Pushbutton for MIN/MAX functions
- 4 Pushbutton for manual range selection
- 5 Multi function pushbutton
- 6 Function selector switch
- 7 Terminal sockets with automatic blocking system
- 8 Pushbutton for HOLD function
- 9 Pushbutton for backlight function
- 10 Main display for digits, decimal point and polarity
- 11 Display for manual range selection, Hold, MIN/MAX, Relative, Peak functions
- 12 Overrange indication
- 13 Bar graph for analog indication
- 14 Sub-display for digits, decimal point and polarity
- 15 Display for the unit of measured quantity
- 16 Display for indication of Auto Off Function
- 17 Display for diode testing
- 18 Buzzer indication
- 19 hFE: no function here
- 20 Low battery indication
- 21 Display for the selected function i. e. AC or DC

### **Standard Equipment**

- 1 Multimeter
- 1 Protective rubber cover
- 1 Cable set
- 2 Batteries, 1.5 V, type AA, installed
- 1 Operating instructions

<b>Contents</b>	<b>Page</b>
<b>1 Introduction</b> .....	<b>6</b>
<b>2 Safety Features and Safety Precautions</b> .....	<b>6</b>
<b>3 Switching the Multimeter „ON“</b> .....	<b>9</b>
<b>4 Function and Range Selection</b> .....	<b>10</b>
4.1 Switching the Measuring Ranges .....	10
4.2 Auto / Manual Ranging .....	10
<b>5 Liquid Crystal Display (LCD)</b> .....	<b>11</b>
5.1 Digital Display .....	11
5.2 Analog Indication .....	12
5.3 Backlight .....	12
<b>6 HOLD and Delay Hold Feature</b> .....	<b>13</b>
6.1 HOLD Feature .....	13
6.2 Delay Hold Feature .....	13
<b>7 MIN/MAX Feature</b> .....	<b>13</b>
<b>8 Peak Measurement</b> .....	<b>14</b>
<b>9 Voltage Measurement</b> .....	<b>15</b>
<b>10 Current Measurement</b> .....	<b>16</b>
10.1 AC Current Measurement with (Clip-on) Current Transformer .....	17
10.1.1 Transformer Output mA/V .....	17
10.1.2 Transformer Output V .....	18
<b>11 Resistance Measurement</b> .....	<b>19</b>
<b>12 Continuity Test and Diode Test</b> .....	<b>20</b>
12.1 Continuity Test .....	20
12.2 Diode Test .....	20
<b>13 Capacitance Measurement (METRALINE DM 62 only)</b> .....	<b>23</b>
<b>14 Frequency and Duty Measurement (METRALINE DM 62 only)</b> .....	<b>24</b>

14.1	Frequency Measurement .....	24
14.2	Duty Cycle Measurement .....	24
<b>15</b>	<b>Temperature Measurement .....</b>	<b>25</b>
<b>16</b>	<b>Technical Characteristics .....</b>	<b>26</b>
<b>17</b>	<b>Maintenance .....</b>	<b>32</b>
17.1	Battery .....	32
17.2	Fuses .....	33
17.3	Case .....	34
17.4	Device Return and Environmentally Compatible Disposal .....	34
<b>18</b>	<b>Product Support .....</b>	<b>35</b>
<b>19</b>	<b>Repair and Replacement Parts Service Calibration Center and Rental Instrument Service .....</b>	<b>35</b>
<b>20</b>	<b>Manufacturer's Warranty .....</b>	<b>36</b>
<b>21</b>	<b>Registration .....</b>	<b>36</b>

## 1 Introduction

Thank you very much for selecting our multimeter. These multimeters are manufactured as per IS 13875 and DIN 43751.

## 2 Safety Features and Safety Precautions

You have chosen a multimeter which provides you with a very high degree of safety. The analog-digital multimeters are manufactured and tested in compliance with the safety standard IEC 61010-1:2010/ DIN EN 61010-1:2011. In case of incorrect use or careless handling, the safety of both user and multimeter is not guaranteed.

**For proper use and safe handling, it is absolutely necessary to read and understand the operating instructions before using the multimeter.**



For your safety and protection, the multimeters are fitted with an Automatic terminal Blocking System (ABS). It is coupled with the function selector switch which blocks the terminal sockets not necessary for measurement.

### **Please note the following safety precautions**

- The multimeter must be operated only by persons who understand the danger of shock hazards and are aware of the necessary safety precautions. Shock hazards exist wherever voltage of more than 30 V (TRMS) is present.
- Do not work alone in shock hazardous environment while carrying out measurements.
- The maximum permissible voltage between terminal socket (7) and ground is 1000 V.
- Take into account that unexpected voltages may occur on devices under test (e. g. defective instrument). For example, capacitors may be charged to a dangerously high voltage.
- Verify that the test leads are in good condition e. g. no cracked insulation, no open circuits in the leads or connectors.

- This multimeter must not be used for measurements on circuits with corona discharge (high voltage).
- Be particularly careful when measuring on HF circuits. Dangerous composite voltages may exist there. Measurements under moist environmental conditions are not permitted.
- Do not overload the measuring ranges beyond their allowable capacities. Limit values are given in specifications, see section 16.
- All current measuring ranges are protected with a fuse. The maximum permissible voltage of the measuring circuit (nominal voltage of the fuse) is 1000 V AC/DC in the „mA“ and „A“ ranges.
- Protection provided by the digital multimeter may be impaired if the multimeter is not used in a manner specified in this user manual.

### Meaning of the symbols on the device

	Warning concerning a source of danger (Attention, refer to the operating instructions)
	Earth (ground) terminal.
	Double or reinforced insulation
<b>CAT II / III / IV</b>	Instrument for overvoltage category II / III or IV
<b>CE</b>	EU conformity mark
<b>UL</b>	UL approval

## **Opening of Equipment / Repair**

The equipment may be opened only by authorized service personnel to ensure the safe and correct operation of the equipment and to keep the warranty valid.

Even original spare parts may be installed only by authorized service personnel.

In case the equipment was opened by unauthorized personnel, no warranty regarding personal safety, measurement accuracy, conformity with applicable safety measures or any consequential damage is granted by the manufacturer.

## **Repair and Parts Replacement by Authorized Service Personnel**

When the instrument is opened, voltage conducting parts may be exposed. The instrument must be disconnected from the measuring circuit before the performance of repairs or the replacement of parts. If repair of a live open instrument is required, it may only be carried out by trained personnel who are familiar with the dangers involved.

### **Faults and abnormal stress:**

If it has been ascertained that safe operation is no longer possible, take the multimeter out of service and secure it against accidental use. Safe operation may not be possible

- if the multimeter shows obvious signs of damage,
- if the multimeter no longer functions correctly,
- after prolonged storage under adverse conditions,
- on account of severe stress during transport,
- if the multimeter is not being used in compliance with the manner described in this manual.



### 3 Switching the Multimeter „ON“

#### Battery

Your multimeter works on 2 x AA size alkaline manganese batteries per IEC LR6. They are provided with the multimeter. Before you use the multimeter for the first time or after storage, refer to section 17.1. Set the rotary knob (6) to other than the „OFF“ position to switch the multimeter ON. Switch „ON“ is acknowledged by an acoustic signal. All segments of the LCD will be displayed as shown on page 2.

#### Note:

Electric discharges and high-frequency influence may cause incorrect information to be displayed and block the measuring process. Reset the multimeter by switching it OFF and ON again. Otherwise, check the battery connections. Disconnect the multimeter from the measuring circuit before you open it, and refer to section 17.

#### Automatic Meter-OFF (MoFF)

The digital multimeter has a default auto meter-off function. If the multimeter is idle for more than 15 minutes, the multimeter automatically turns the power off. When **MoFF** happens, the state of the multimeter is saved. The „**MoFF**“ (16) sign on the LCD panel indicates whether the **MoFF** is enabled or not. In some cases, the user might want to disable this feature. Power ON the multimeter by pressing any of the push functions except for the HOLD (8) and multifunction (5) pushbuttons. After auto meter-off, pushing any of the push functions or changing the rotary switch mode can turn on the multimeter again. If the multimeter is re-powered by changing the rotary mode, the saved state is cleared. If the multimeter is re-powered by push functions, the chip restores the saved state and enters HOLD mode. The LCD displays the saved value.

#### Turning the multimeter OFF

To turn OFF the multimeter, set the rotary knob (6) to the „OFF“ position.

## 4 Function and Range Selection

The function selector switch (6) is coupled with the Automatic terminal Blocking System (ABS) which allows access only to two correct sockets for each function. Prior to switching to the „mA“ or „A“ functions or from the „mA“ or „A“ functions, remove the test lead from the corresponding socket. When the test leads are plugged in, the terminal blocking system prevents accidental switching to non permissible functions.

### 4.1 Switching the Measuring Ranges

The 660 mVAC and 660 mVDC measuring ranges are not automatically selected when the multimeter is switched ON. The above ranges can only be selected manually with the „AUTO/MAN“ key.

### 4.2 Auto / Manual Ranging

The multimeter features auto ranging for all measuring ranges with the exception of the °C, °F, continuity, Diode, %, AAC, ADC. Autoranging is automatically selected after switching the multimeter ON. According to the measured quantity applied, the multimeter automatically selects the measuring range which gives the best resolution. You can switch OFF auto-ranging and select the ranges manually according to the table shown in this section. Manual mode is switched OFF when pushbutton AUTO/MAN is pressed (4) for approximately 1 s, or when the function selector switch (6) is operated, or when the multimeter is turned OFF and ON again.

↓ AUTO/ MAN (4)	Function	Acknowledgement
		Display
brief	Manual mode <b>ON</b> : utilized measuring range is fixed	MAN (11)
brief	Range switching sequence for: VAC/VDC: 6.6 V → 66 V → 660 V → 1000 V → 660 mV → 6.6 V ... mA AC/mA DC: 66 mA → 660 mA → 66 mA ... Ω: 660 Ω → 6.6 kΩ → 66 kΩ → 660 kΩ → 6.6 MΩ → 66 MΩ → 660 Ω F: 6.6 nF → 66 nF → 660 nF → 6.6 μF → 66 μF 660 μF → 6.6 mF → 40 mF → 6.6 nF ... Hz: 66 Hz → 660 Hz → 6.6 kHz → 66 kHz → 660 kHz → 6.6 MHz → 10 MHz → 66 Hz...	MAN (11)
long	Return to automatic range selection	AUTO (11)

Note: °C, Continuity, Diode, AAC, ADC, % all functions have fixed range.



## 5 Liquid Crystal Display (LCD)

### 5.1 Digital Display

The main digital display (10) shows the measured value with correct location of decimal point and sign. The selected measuring unit (15) and the function (21) are simultaneously displayed. When measuring DC quantities, a minus sign appears in front of the digits, when the positive pole of the measured quantity is applied to the „**↓**“ input terminal. When upper range limit 6600 (on the range **▶**:1999) is exceeded, „OL“ is displayed. The digital display is updated 2.8 times per second. The digital sub-display (14) shows the measured value with correct location of decimal point and sign. The main purpose of the two digital displays is to display simultaneous measurement as mentioned below:

Main Display	Sub-display
Voltage	Frequency
Voltage	Min/Max
Frequency	Duty cycle
Current	Frequency

## 5.2 Analog Indication

The analog indication with bar graph is updated 28 times per second. Analog indication is of particular use when observing variations of measured values. The analog bar graph (13) has its own polarity indication in measuring DC quantities, when the positive pole of the measured quantity is applied to the „“ input terminal. Analog bar graph has 65 scale divisions so that variations of the measured values around „zero“ can be observed exactly. The overrange is indicated by the right triangle (12) when measured value is > 6600 counts (for  measurement > 1999).

## 5.3 Backlight

The instrument is provided with user selectable backlight for taking measurements in poor lighting conditions/dark areas.

### Switching the backlight ON

By pressing  (9) key, the backlight can be switched ON for 60 s.

### Switching the backlight OFF

By pressing the  (9) key once again before 60 s, the backlight can be switched OFF. Otherwise it switches off automatically after 60 s.

## **6 HOLD and Delay Hold Feature**

### **6.1 HOLD Feature**

After pressing the „HOLD“ (8) button, the multimeter stops updating the LCD panel. After enabling the HOLD function, the multimeter switches from AUTO to the manual ranging mode, but the measuring range remains the same.

### **6.2 Delay Hold Feature**

The multimeter provides a delay HOLD feature. To activate the delay HOLD feature, press the „HOLD“ (8) button for 2 seconds. The multimeter will wait for 6 seconds, then enters HOLD mode. During the 6 second period, the HOLD symbol on the LCD will blink and after 6 seconds, the multimeter will hold the measured value present on the LCD. To exit the delay HOLD function, either change range or press the „AUTO/MAN“ (4) or „HOLD“ (8) button again.

## **7 MIN/MAX Feature**

With the MIN/MAX function, you can hold the minimum and maximum measured value which has been applied to the input of the multimeter after activating the MIN/MAX function. The most important application is the determination of the minimum and maximum value for long-term monitoring of measured parameters. The actual measured value can still be noted/read during this feature. Apply the measured quantity to the multimeter and select the measuring range prior to activating the MIN/MAX function. With the function activated, you can select the measuring ranges only manually, if you switch to another range, the stored MIN/MAX values are cleared. After pressing MIN/MAX (3) for the first time, the sub-display shows maximum value. The sub-display shows minimum value when it is pressed again. The main display always shows the current value in MIN/MAX mode. To exit from this mode, either press and hold the MIN/MAX (3) button for longer than one second, operate the function selector switch (6) or turn the multimeter OFF and ON again. Pressing HOLD (8) in MIN/MAX mode

makes the multimeter stop updating the maximum or the minimum value.

### **Note**

MIN/MAX function is available in all measuring ranges except in Hz.

## **8 Peak Measurement**

METRALINE DM 61 and 62 provide a peak hold function to capture the maximum or minimum peak value. To enter peak mode, press the PEAK (2) pushbutton for less than 1 second. A self-calibration process will be executed automatically before normal peak-hold operation. In peak mode, the main display shows the current value of signal, and the sub-display shows the PMAX or PMIN value which is selected by the PEAK key. After pressing the PEAK (2) pushbutton for the first time, the sub-display shows the PMAX value. The sub-display shows the PMIN value when the PEAK (2) pushbutton is pressed again. To exit the PEAK-hold function, either press the PEAK key for more than 1 second, operate the function selector switch (6) or turn the multimeter OFF and ON again.

## 9 Voltage Measurement

According to the voltage to be measured, set the function selector switch (6) to V AC or V DC. Connect the test leads as shown. The „**L**“ socket should be connected to the lowest potential ground available. In V AC mode, the main display always shows voltage and the sub-display shows frequency.

### Note

The 660 mV measuring ranges can only be selected manually with the „AUTO/MAN“ (4) pushbutton.

### Caution

Ensure that the current measuring range („mA“ or „A“) is not selected during voltage measurement! If the cut-out rating of the fuses is exceeded due to improper operation, a dangerous situation may occur!

Voltage measurement

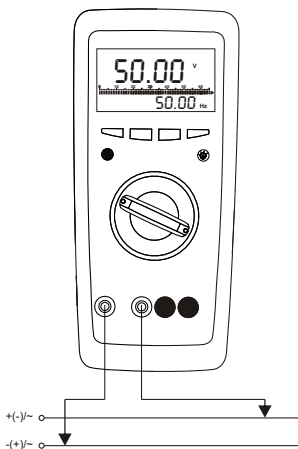

## 10 Current Measurement

- First disconnect the power supply to the circuit being measured and/or to the load, and discharge all capacitors within that circuit.
- With the function selector switch (6), select A for currents  $> 660$  mA and mA for currents  $\leq 660$  mA. When measuring current of unknown magnitude, select the highest measuring range first.
- Select the function corresponding to the measured quantity by briefly pressing the yellow multi-function (5) pushbutton.
- Each time the pushbutton is pressed, alternate switching takes place between DC and AC. The change-over is acknowledged by an acoustic signal.
- The symbols DC and AC (21) are displayed as per selected function on the LCD.
- When selecting a range with the function selector switch (6), the DC function is always set by default.
- Connect the multimeter in series with the load, as shown. Ensure that the connections are tight (with least resistance).

### Notes on current measurement

- The multimeter must be used only in the power systems, where the current circuit is protected by a fuse or a circuit breaker of 20 A, and when the nominal voltage of the system does not exceed 1000 V AC/DC.
- Carefully secure the measuring circuit connections by mechanical means so that they do not accidentally open. The conductor cross sections and connection points should be designed so as to avoid excessive heating.



- The current measuring ranges up to 660 mA are protected against a short circuit current of 25 A by a 1.6 A / 1000 V AC/DC fuse in conjunction with power diodes. The cut-out capacity of the fuse is 10 kA at a rated voltage of 1000 V AC/DC and ohmic load.
- The 10 A current measuring ranges are protected by a 10 A / 1000 V AC/DC fuse. The cut-out capacity of the fuse is 30 kA at a nominal voltage of 1000 V AC/DC and ohmic load.
- Replacement of the fuses is described in section 17.

## 10.1 AC Current Measurement with (Clip-on) Current Transformer

### 10.1.1 Transformer Output mA/A

#### Caution

If current transformers are operated with an open circuit on the secondary side, e. g. due to defective or disconnected leads, a blown fuse in the multimeter, or a wrong connection, dangerously high voltages may occur at the connectors. Therefore, make sure that the current circuit of the multimeter and secondary winding of the transformer connected to the multimeter form an intact circuit. Connect the transformer to the **⏏** and mA or A sockets. The maximum permissible operating voltage is the nominal voltage of the current transformer. When reading the measured value, take into account the transformer ratio and the additional error in indication.

#### Transformer output METRALINE DM 61

The METRALINE DM 61 shows the switching position and the corresponding sockets. Connect a (clip-on) current transformer with a transmission ratio of 1000:1 to this socket. The measured values are then displayed directly in the „A“ range.

## 10.1.2 Transformer Output V

Many transformers have a voltage output (referred to as mV/A). The secondary output must therefore be connected to the connection sockets „**L**“ and „**V**“.

### Current measurement

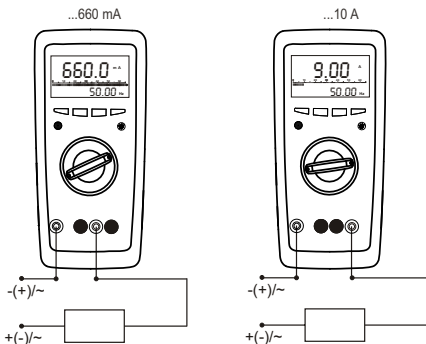

### AC current measurement with (clip-on) current transformers

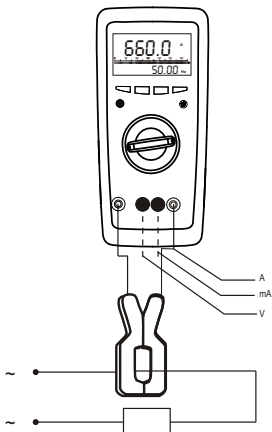

## 11 Resistance Measurement

- Verify that the device under test is electrically dead. External voltages would falsify the measured result!
- Set the function selector switch (6) at „ $\Omega$ “.
- Connect the device under test as shown.

### Zero adjustment on the 660 $\Omega$ measuring range

When measuring small resistance values on the 660  $\Omega$  range, you can eliminate the resistance of the leads and contact resistance by means of the REL function.

- Connect the test leads with the multimeter and join the free ends.
- Press and hold the PEAK (2) key and press the AUTO/MAN (4) pushbutton. The multimeter enters into the „REL“ mode. The „REL“ symbol is displayed on the LCD.
- The value „00.00“ (+1 digit) is shown on the main display while the resistance value measured at the time of pressing the pushbuttons is indicated on the sub-display and used as reference value.
- This value is automatically deducted from the values measured subsequently.

### The REL function can be cleared

- by pressing and holding the PEAK pushbutton and then pressing the AUTO/MAN key. This is acknowledged by acoustic signals.
- by switching the multimeter off.

## 12 Continuity Test and Diode Test

- Verify that the device under test is electrically dead. External voltages would falsify the measured results!

### 12.1 Continuity Test

- Set the function selector switch (6) at „ $\Omega$ “, then press the yellow multi-function pushbutton (5). The multimeter acknowledges turn-ON with an acoustic signal.
- At the same time,  $\square$ ) (18) appears on the LCD and „OL“ is displayed on the main display.
- An acoustic signal is generated whenever the reading is less than 30  $\Omega$ .

### 12.2 Diode Test

- Set the function selector switch (6) at „ $\Omega$ “, then press the yellow multi-function pushbutton (5) twice. The multimeter acknowledges turn ON with an acoustic signal.
- At the same time,  $\rightarrow|$  (18) appears on the LCD and „OL“ is displayed on the main display.
- The multimeter displays the forward voltage in Volts.
- As long as the voltage drop does not exceed the maximum display value of 1.999 V, you can also test several series-connected elements or reference diodes with a small reference voltage.
- Reverse direction or open circuit: the multimeter indicates overrange „OL“.
- With the diode function selected, the multimeter emits a continuous acoustic signal whenever the reading is less than 30 mV.

#### Note

Resistors and semiconductor junction in parallel with the diode falsify the measured results!

## Changing between resistance, continuity, diode testing

Repeated brief pressing of the yellow multi-function switch (5) changes the measuring functions in the following order:

Resistance → Continuity → Diode → Resistance...

### Resistance Measurement

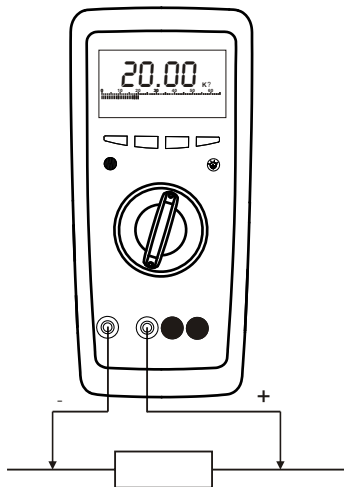

## Continuity Test

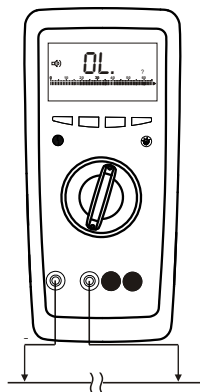
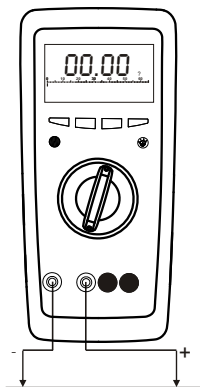

## Diode Test

### Forward direction

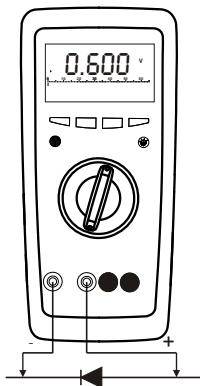

### Reverse direction

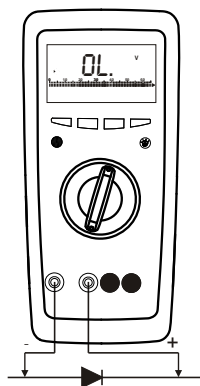

### 13 Capacitance Measurement (METRALINE DM 62 only)

- Verify that the device under test is electrically dead. External voltages would falsify the measured results!
- Set the function selector switch (6) at „**⊥**“.
- Connect the (discharged !) device under test to the „**⊥**“ and „**⊥**“ sockets via test lead.

#### Note

- Connect polarized capacitors with the „**-**“ pole to the „**⊥**“ socket.
- Resistors and semiconductor junctions in parallel with the capacitor falsify the measured results!

#### Zero adjustment on the 6.600 nF measuring range

When measuring small capacitance values on the 6.600 nF range, the internal resistance of the multimeter and the capacitance of the leads can be eliminated by the „REL“ function.

- Connect the test leads to the multimeter without a device under test.
- Press and hold the PEAK (2) key and press the AUTO/MAN (4) pushbutton. The multimeter enters into the „REL“ mode. The „REL“ symbol is displayed on the LCD. The value „00.00“ (+1 digit) is shown on the main display while the capacitance measured at the time of pressing the pushbuttons is displayed on the sub-display and used as a reference value. This value is automatically deducted from the values measured subsequently.

#### The REL function can be cleared

- by pressing and holding the PEAK pushbutton and then pressing the AUTO/MAN key. This is acknowledged by acoustic signals.
- by switching the multimeter off.

## 14 Frequency and Duty Measurement (METRALINE DM 62 only)

### 14.1 Frequency Measurement

- Set the function selector switch (6) at „Hz“
- The multimeter switches to frequency measurement. The frequency is displayed on the main display and duty cycle is displayed on the sub-display. See section 16 for the lowest measurable frequencies and the maximum permissible voltages.
- Connections are established in the same way as for voltage measurement.

### 14.2 Duty Cycle Measurement

With duty cycle measurement, the user can determine the ratio of pulse duration to cycle time of recurring square-wave signals.

- Set the function selector switch (6) at „Hz“.
- The multimeter switches to frequency measurement. The frequency is displayed on the main display and duty cycle is displayed on the sub-display.
- The duty cycle (i.e. the percentage pulse duration of a signal) is displayed on the LCD in %
- That is:

$$\text{Duty cycle (\%)} = \frac{\text{Pulse duration}}{\text{Cycle duration}} \times 100$$

#### Note

- The applied frequency must remain constant during duty cycle measurement.



## 15 Temperature Measurement

The METRALINE DM 61 and METRALINE DM 62 multimeters allow the user to measure temperature with a K type thermocouple in the range from  $-50\text{ }^{\circ}\text{C}$  ...  $1300\text{ }^{\circ}\text{C}$ .

- Set the function selector switch (6) at „ $^{\circ}\text{C}$ “
- Connect the multimeter probe with the two unblocked terminals and the thermocouple output.
- The multimeter measures temperature in  $^{\circ}\text{C}$ .
- To measure temperature in F, press the yellow multi-function pushbutton (5).

### Changing between $^{\circ}\text{C}$ and $^{\circ}\text{F}$

Repeated brief pressing of the yellow multi-function switch (5) changes the measuring functions in the following order:

$^{\circ}\text{C} \rightarrow ^{\circ}\text{F} \rightarrow ^{\circ}\text{C} \dots$

The analog scale is disabled in temperature measurement mode.

## 16 Technical Characteristics

Meas. Function	Measuring Range	DM61	DM62 (TRMS)	Resolution	Input Impedance	Digital display inherent deviation at reference condition + (...% rdg. + ...digits)	Overload Capacity 1)	
							Overload Values	Overload Duration
V(DC)	660.0 mV	•	•	100 $\mu$ V	>100 M $\Omega$ // <40pF	0.7 + 5	1000 V DC AC eff/rms sine wave	cont.
	6.600 V	•	•	1 mV	11 M $\Omega$ // <40pF	0.4 + 5		
	66.00 V	•	•	10 mV	10 M $\Omega$ // <40pF	0.4 + 5		
	660.0 V	•	•	100 mV	10 M $\Omega$ // <40pF	0.4 + 5		
	1000 V	•	•	1 V	10 M $\Omega$ // <40pF	0.4 + 5		
V(AC)	660.0 mV	•	•	100 $\mu$ V	>100 M $\Omega$ // <40pF	1.2 + 5	1000 V DC AC eff/rms sine wave	cont.
	6.600 V	•	•	1 mV	11 M $\Omega$ // <40pF	1.0 + 3		
	66.00 V	•	•	10 mV	10 M $\Omega$ // <40pF			
	660.0 V	•	•	100 mV	10 M $\Omega$ // <40pF			
	1000 V	•	•	1 V	10 M $\Omega$ // <40pF			
A(DC)					Voltage Drop			
	66.00 mA	•	•	10 $\mu$ A	66.00 mV	0.8 + 5	0.7 A	cont.
	660.0 mA	•	•	100 $\mu$ A	66.00 mV	0.8 + 5		
	10.00 A	—	•	10 mA	10.00 mV	1.5 + 5	12 A	cont.
A(AC)	66.00 mA	•	•	10 $\mu$ A	66.00 mV	0.8 + 5	0.7 A	cont.
	660.0 mA	•	•	100 $\mu$ A	66.00 mV	0.8 + 5		
	10.00 A	—	•	10 mA	10.00 mV	1.5 + 5	12 A	cont.
$\Sigma$ (AC) <sup>5)</sup>	66.00 A	•	—	10 mA	66.00 mV	0.8 + 5	0.7 A	cont.
	660.0 A	•	—	100 mA	66.00 mV	0.8 + 5		
$\Omega$					no-load Voltage			
	660.0 $\Omega$	•	•	100 m $\Omega$	-3.3 V	0.8 + 5	1000 V DC AC eff/rms sine wave	max. 10 s
	6.600 k $\Omega$	•	•	1 $\Omega$	-1.08 V	0.8 + 5		
	66.00 k $\Omega$	•	•	10 $\Omega$	-1.08 V	0.8 + 5		
	660.0 k $\Omega$	•	•	100 $\Omega$	-1.08 V	0.8 + 5		
	6.600 M $\Omega$	•	•	1 k $\Omega$	-1.08 V	1.0 + 5		
	66.00 M $\Omega$	•	•	10 k $\Omega$	-1.08 V	2.0 + 5		

Meas. Function	Measuring Range	DM61	DM62 (TRMS)	Resolution	Input Impedance	Digital display inherent deviation at reference condition +(...% rdg. +...digits)	Overload Capacity 1)	
							Overload Values	Overload Duration
	660.0 Ω	•	•	100 mΩ	-3.3 V	0.8 + 5	1000 V DC AC eff/rms sine wave	max. 10 s
DIODE	2.000 V	•	•	1 mV	3.3 V	2.0 + 10		
F	6.600 nF	—	•	1 pF	—	3.0 + 40		
	66.00 nF	—	•	10 pF		2.0 + 10		
	660.0 nF	—	•	100 pF		2.0 + 10		
	6.600 μF	—	•	1 nF		2.0 + 10		
	66.00 μF	—	•	10 nF		2.0 + 10		
	660.0 μF	—	•	100 nF		5.0 + 10		
	6.600 mF	—	•	1 μF		5.0 + 10		
	40.00 mF	—	•	10 μF		5.0 + 10		
Hz	66.00 Hz	—	•	0.01 Hz	10 Hz (f min)	0.2 + 2 <sup>2)</sup>		
	660.0 Hz	—	•	0.1 Hz				
	6.600 kHz	—	•	1 Hz				
	66.00 kHz	—	•	10 Hz				
	660.0 kHz	—	•	100 Hz				
	6.600 MHz	—	•	1 kHz				
	10.00 MHz	—	•	10 kHz				
%	1.0 ... 98.90%	—	•	0.01 %	0.9% (% min)	10 Hz ... 1 kHz ±5 digit <sup>3)</sup> 1...10 kHz; ±5 digit/kHz		
°C/°F	0 ... 1300 °C	•	•	1 °C	—	2,0 ± 3 <sup>4)</sup>		
	-50 ... 0 °C	•	•	1 °C	—	2,0 ± 10 <sup>4)</sup>		

1) at 0 °C ... + 40 °C

2) at input > 3.5 Vrms

3) for < 10 kHz at 5 Vp-p

4) without sensor

5) display with current transformers 1000:1

## Influencing quantities and influence error

Influencing Quantity	Range of Influence	Measured Quantity/ Measuring Range	Variation <sup>1)</sup> ±(... % of rdg. + ... digits)
Temperature	0 °C ... +21 °C and +25 °C ... +40 °C	V DC, V AC	1 x intrinsic uncertainty/K
		A DC, A AC	
		Ω	
		Diode	
		F, Hz, %, °C	
Measured quantity frequency	20 Hz ... < 50 Hz	660 mV~	1.0 + 3
	> 50 Hz ... 200 Hz		5.0 + 3
	20 Hz ... < 50 Hz	6.6 ... 1000 V~	1.0 + 3
	> 50 Hz ... 2 kHz		5.0 + 7
	> 50 Hz ... 200 Hz	A~	1.0 + 3
	20 Hz ... < 2 kHz		5.0 + 3
Crest factor CF	1 ... 1.4	V~ <sup>3)</sup> , A~ <sup>3)</sup>	±1% of rdg.
	1.4 ... 5 <sup>2)</sup>		±5% of rdg.
Battery voltage	 <sup>4)</sup> ... < 2.49 V > 2.49 V ... 3 V	V DC	5 digit
		V~, A DC	10 digit
		A AC	6 digit
		660 Ω	4 digit
		6.600 kΩ ... 66.00 MΩ	3 digit
		nF, F, mF, Hz, %	5 digit
Relative humidity	75%  3 days  Meter off	V~, V DC A~, A DC Ω F Hz °C %	1 x intrinsic uncertainty

<sup>1)</sup> with temperature: Error data apply per 10 K change in temperature.

With frequency: Error data apply to a display from 300 digits onwards.

<sup>2)</sup> with unknown waveform (crest factor CF > 2), measure with manual range selection

<sup>3)</sup> with the exception of sinusoidal waveform.

<sup>4)</sup> after the „“ symbol is displayed.

Influencing Quantity	Range of Influence	Measuring Range	Attenuation
Common Mode Interference Voltage	Noise quantity max. 1000 V $\equiv$	V $\equiv$	> 100 dB
		V $\sim$	> 100 dB
	Noise quantity max. 1000 V $\sim$ 50 Hz, 60 Hz sinusoidal	V $\equiv$	> 100 dB
		V $\sim$	> 50 dB
Normal Mode Interference Voltage	Noise quantity: V $\sim$ , value of the measuring range at a time max. 1000 V $\sim$ , 50 Hz, 60 Hz sinusoidal	660 mV, 6.6 V, 660 V, 1000 V DC	> 43 dB
		66 V DC	> 35 dB
	Noise quantity max. 1000 V $\text{—}$	V $\sim$	> 45 dB

## Display

Liquid crystal display (58 mm x 31.4 mm) with analog indication and digital display with display of the unit of measured quantity, function and various special functions.

## Analog

Indication	LCD scale with bar graph
Scale length	55 mm
Scaling	65 scale divisions during all the measurement
Polarity indication	With automatic reversal
Overrange indication	By triangle
Sampling rate	28 times/s

## Digital

Height of main display numerals	7 segment numerals: 12 mm
Height of sub-display numerals	7 segment numerals: 7 mm
Number of counts	4 digit: 6600 counts
Overrange display	„OL“ is shown
Polarity display	„-“ sign is shown when positive pole connected to „ $\perp$ “
Sampling rate	2.8 times/s

## Power supply

Battery	2 x AA size alkaline manganese batteries per IEC LR6.
Service life	for METRALINE DM 61: 600 hrs. for V DC, A DC 300 hrs. for V AC, A AC for METRALINE DM 62: 400 hrs. for V DC, A DC 200 hrs. for V AC, A AC
Battery test	Automatic display of „  “ symbol when battery voltage falls below following value: approx. 2 V.

## Electromagnetic compatibility (EMC)

Emission	EN 61326: 2013 Class B
Immunity	IEC 61000-4-2: 8 kV atmospheric discharge 4 kV contact discharge IEC 61000-4-3: 3 V/m

Short-term measured value deviation may occur during electromagnetic interference thus reducing the specified operating quality.

## Safety: IEC 61010-1-2010

Measuring category	600 V CAT III, 300 V CAT IV The maximum voltage of 1000 V may only be used with CAT II.
High Voltage Test	6.7 kV (IEC 61010-1-2010)

## Fuse for up to 660 mA ranges

FF (UR) 1.6 A / 1000 V AC/DC; 6.3 mm X 32 mm; rating 10 kA with 1000 V AC/DC and ohmic load; in conjunction with power diodes, protects all current measuring ranges up to 660 mA.

## Fuse for up to 10 A ranges (METRALINE DM 62)

FF (UR) 10 A / 1000 V AC/DC; 10 mm x 38 mm; rating 30 kA with 1000 V AC/DC and ohmic load; protects the 10 A ranges up to 1000 V AC/DC, see section 17 for types of fuses.

**Note:** Defective fuses are not displayed!

## Response Time (after manual range selection)

Measured Quantity/ Measuring Range	Response Time		Transient response for step function of the measured quantity
	Analog Display	Digital Display	
V $\overline{\sim}$ , V $\sim$ , °C	0.1 s	1 s	from 0 to 80% of the upper range limit
A $\overline{\sim}$ , A $\sim$	0.1 s	1 s	from 0 to 50% of the upper range limit
660 $\Omega$ ... 6.6 M $\Omega$	0.1 s	1 s	
66 M $\Omega$	0.2 s	2 s	from 0 to 80% of the upper range limit
$\rightarrow$	0.1 s	1 s	
6.6 nF ... 66 $\mu$ F	0.7 s	max. 1 s	
660 $\mu$ F ... 6.6 mF	1.4 s	max. 3 s	
66 mF	7.0 s	max. 15 s	
660 Hz, 6.6 kHz	2.0 s	max. 2 s	
66 kHz, 660 kHz, 1 MHz	0.5 s	max. 1 s	
% ( $\geq$ 10 Hz)	0.7 s	max. 2.5 s	

### Reference conditions

Ambient temperature	23 °C+ 2 K
Relative humidity	45% ... 55 % RH
Frequency of measured quantity	50 or 60 Hz $\pm$ 2%
Waveform of the measured quantity	sinusoidal
Battery voltage	3 V $\pm$ 0.1 V

### Environmental conditions

Functional temperature range	-10 °C ... 50 °C
Storage temperature range	-25 °C ... +70 °C (without batteries)
Relative humidity	45 ... 75 %
Altitude	up to 2000 m

### Mechanical configuration

Protection for the multimeter	IP50
Pollution degree	2
Connection sockets	IP20 according to EN 60529

Dimensions	86 mm x 185 mm x 55 mm
Weight	480 g approx., including battery and holster

## 17 Maintenance

### Caution

Disconnect the multimeter from the measuring circuit before you open it to replace the battery or the fuse!

### 17.1 Battery

Prior to initial start-up or after storage of multimeter, verify that the batteries inserted in the multimeter do not leak. Repeat this check at regular brief intervals. If the batteries are leaking, remove them carefully and entirely with a moist cloth and install new batteries before putting the multimeter back into operation. When the symbol „“ (17) appears on the LCD (1), replace the batteries as soon as possible. Although measurements can still be performed, a reduced measuring accuracy must be taken into account in this case. The multimeter operates with 2 x AA size alkaline manganese batteries per IEC LR6.

### Replacing the Battery

- Place the multimeter on its face, loosen the single screw on the rear side and remove the battery cover.



#### Attention!

Remove the batteries by levering out the **negative pole** of the batteries with a screw driver **first**. Otherwise, the contacts of the positive pole in the battery compartment might be damaged and the battery lead severed.

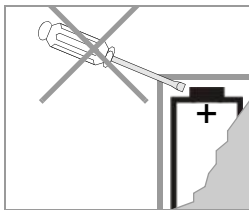

- Remove the batteries from the battery compartment and replace them with new ones (for technical specifications refer to sub-section „Power supply“).





### **Attention!**

When inserting the batteries, begin with the positive pole of the battery and fit the negative pole into place afterwards, in order to avoid damage to the contacts of the positive pole.

---

- ⇒ Tighten the battery cover with the screw.

## **17.2 Fuses**

The 10 A fuse protects the 10 A range, the 1.6 A fuse protects the 66 mA, 660 mA current measuring ranges. When a fuse blows, eliminate the cause of the overload before using the multimeter again!

### **Replacing the Fuses**

- Place the multimeter on its face, loosen the two bottom cover screws on the rear and remove the bottom cover by lifting it from the bottom.
- Remove the defective fuse from the fuse holders.
- Remove the blown fuse, e. g. with the aid of a probe, and replace it with a new one.
- Tighten the bottom cover with the two screws.

Fuse types for current measuring ranges up to 660 mA:

- FF (UR) 1.6 A / 1000 V AC/DC; (10 kA); 6.3 mm x 32 mm

For 10 A current measuring range:

- FF (UR) 10 A / 1000 V AC/DC; (30 kA); 10 mm x 38 mm

### **Caution**

It is imperative to ensure that only the fuses specified above are installed!

If a fuse of other cut-out capacity, other nominal current or other switching capacity is used, a dangerous situation exists, and there is a risk of damaging protective diodes, resistors or

other components. The short-circuiting of the fuse holder is not permissible.

### 17.3 Case

No special maintenance is required for the housing. Keep outside surfaces clean. Use a slightly dampened cloth for cleaning. Avoid the use of cleansers, abrasives or solvents.

### 17.4 Device Return and Environmentally Compatible Disposal

The instrument is a category 9 product (monitoring and control instrument) in accordance with ElektroG (German Electrical and Electronic Device Law). This device is subject to the RoHS directive. Furthermore, we make reference to the fact that the current status in this regard can be accessed on the Internet at [www.gossenmetrawatt.com](http://www.gossenmetrawatt.com) by entering the search term WEEE.

We identify our electrical and electronic devices in accordance with WEEE 2012/19/EU and ElektroG using the symbol shown at the right per DIN EN 50419.



These devices may not be disposed of with the trash. Please contact our service department regarding the return of old devices (see address in Section 19).

If you use **batteries** or **rechargeable batteries** in your instrument or accessories which no longer function properly, they must be duly disposed of in accordance with the applicable national regulations.

Batteries or rechargeable batteries may contain harmful substances or heavy metals such as lead (Pb), cadmium (Cd) or mercury (Hg).

The symbol shown at the right indicates that batteries or rechargeable batteries may not be disposed of with the trash, but must be delivered to collection points specially provided for this purpose.



## 18 Product Support

If required please contact:

Gossen Metrawatt GmbH

### Product Support Hotline

Phone +49 911 8602-0

Fax +49 911 8602-709

E-Mail [support@gossenmetrawatt.com](mailto:support@gossenmetrawatt.com)

## 19 Repair and Replacement Parts Service Calibration Center\* and Rental Instrument Service

If required please contact:

GMC-I Service GmbH

### Service Center

Beuthener Straße 41

90471 Nürnberg, Germany

Phone: +49 911 817718-0

Fax: +49 911 817718-253

E-mail [service@gossenmetrawatt.com](mailto:service@gossenmetrawatt.com)

[www.gmci-service.com](http://www.gmci-service.com)

This address is only valid in Germany.

Please contact our representatives or subsidiaries for service in other countries.

### \* DAkkS Calibration Laboratory for Measured Electrical Quantities

#### D-K-15080-01-01 accredited per DIN EN ISO/IEC 17025

Accredited quantities: direct voltage, direct current value, direct current resistance, alternating voltage, alternating current value, AC active power, AC apparent power, DC power, capacitance, frequency, temperature

## 20 Manufacturer's Warranty

Digital multimeters of the METRALINE DM series are guaranteed for a period of 3 years after shipment. The manufacturer's warranty covers materials and workmanship. Damages resulting from use for any other than the intended purpose or operating errors, as well as any and all consequential damages, are excluded.

Kindly register each device at myGMC after purchase in order to benefit from the 3 year warranty.

## 21 Registration

Register your device at [www.gossenmetrawatt.com](http://www.gossenmetrawatt.com) → myGMC

### Your Benefits for your digital multimeter

- Backup for serial number
- Free downloads
- Info hotline
- Update information
- Application notes

---

© Gossen Metrawatt GmbH

Edited in Germany • Subject to change without notice / Errors excepted • A PDF version is available on the Internet

All trademarks, registered trademarks, logos, product names, and company names are the property of their respective owners.

 **GOSSEN METRAWATT**

Gossen Metrawatt GmbH  
Südwestpark 15  
90449 Nürnberg • Germany

Phone +49 911 8602-111  
Fax +49 911 8602-777  
E-Mail [info@gossenmetrawatt.com](mailto:info@gossenmetrawatt.com)  
[www.gossenmetrawatt.com](http://www.gossenmetrawatt.com)