

Exposure Metering Compendium

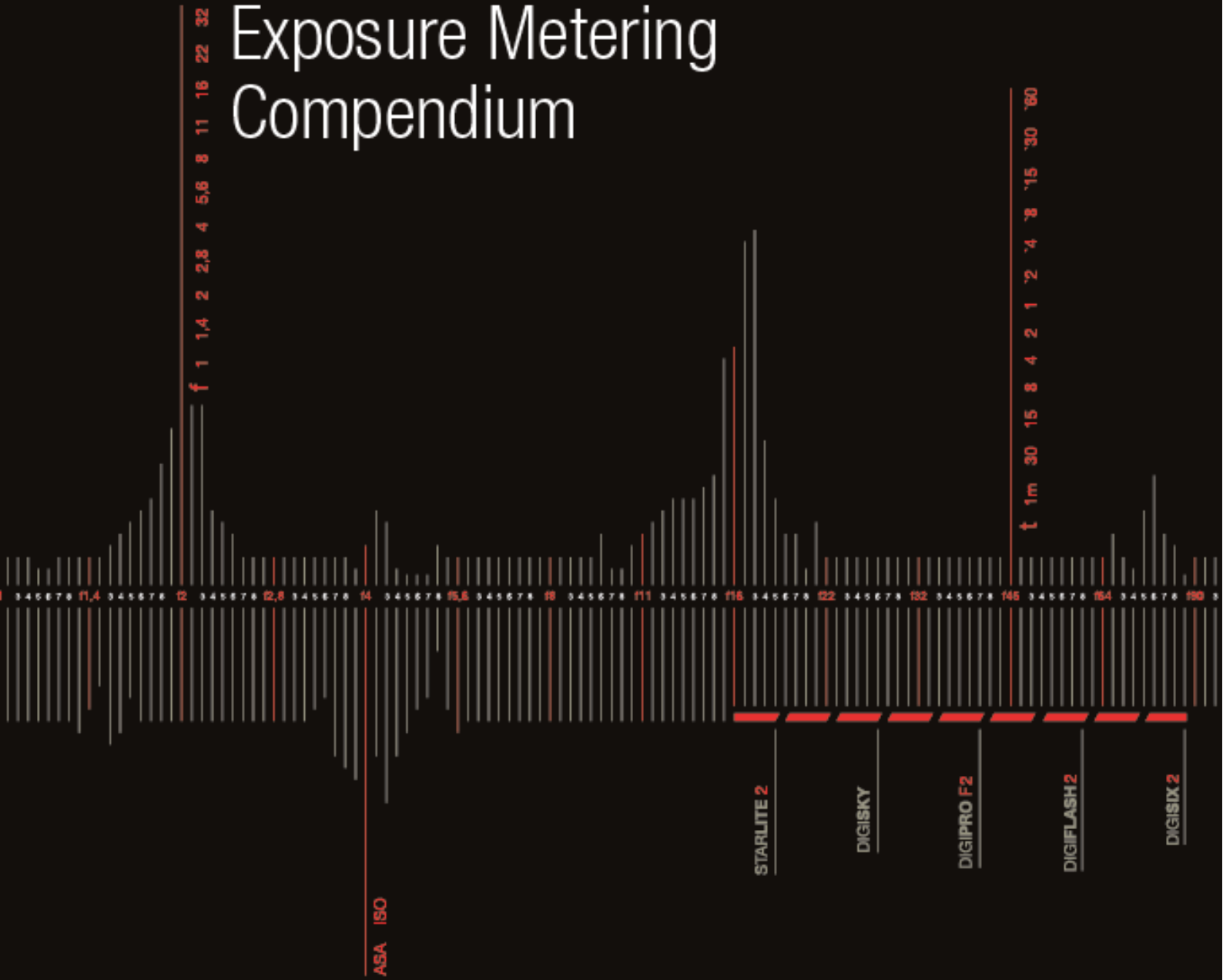

Table of Contents

1	External Exposure Meters Still as Important as Ever	4
2	Light in Photography	9
2.1	Color Rendering	10
2.2	Color Temperature	10
2.2.1	Color Temperature Throughout the Day	11
2.2.2	Color Temperatures of Light Sources	11
2.3	Light Characteristic – Hard and Soft Light	12
2.4	Luminous Intensity – the Inverse-Square Law	13
2.5	Influence of Light Shapers	15
2.6	Light Direction	16
3	White Balance	17
3.1	White Balance in Analog Photography	17
3.2	White Balance in Digital Photography	18
3.2.1	Automatic White Balance	18
3.2.2	Manual White Balance with Presettings	18
3.2.3	Manual White Balance with Gray Reference	18
3.2.4	Manual White Balance with White Balance Filter	19
3.2.5	White Balance under Mixed Lighting Conditions	19
3.2.6	White Balance and Color Profiling	20
3.3	White Balance in the Digital Camera	21
4	Fundamentals of Exposure	22
4.1	The Exposure Triangle	22
4.2	F-Stop	23
4.3	Shutter Speed	23
4.4	Shutter Speed / F-Stop Combinations	24
4.5	ISO Sensitivity	24
5	How does an Exposure Meter Work?	25
5.1	Standardization to 18% Gray	25
5.2	Exposure Value (EV)	25
6	Measuring Methods	26
6.1	Reflected Light Measurement	26
6.1.1	Average Metering	27
6.1.2	Center-Weighted Average Metering	27
6.1.3	Spot Metering	27

6.1.4	Selective Metering.....	27
6.1.5	Multi-Segment Metering, Matrix Metering	28
6.1.6	2-Point Metering	28
6.1.7	Substitution Measurement with Gray Card	28
6.1.8	Reflected Light Metering Methods of Cameras	29
6.2	Incident Light Measurement	29
7	Flash Exposure Metering	31
7.1	Adjusting Studio Lighting – Lighting Contrast	31
7.2	Triggering the Flash Unit with the Camera	33
7.3	Triggering and Metering with the Exposure Meter.....	33
7.4	Combining Flash and Continuous Light	33
8	The Zone System.....	35
9	The Histogram	36
10	Controlling Contrast.....	37
11	Recommended Reading	39

1 External Exposure Meters Still as Important as Ever

One of the most frequently asked questions is: *“Is a handheld exposure meter still necessary at all for digital photography? My camera is capable of matrix metering, center-weighted metering and spot metering – what more could I possibly need? I see the image results immediately at my display and in the histogram, and I correct exposure there. If necessary, I get rid of any image recording flaws later at my PC with image processing software. Why should I work with a museum piece like the one my grandfather used?”*



In order to answer this question, we first have to look at what differentiates digital photography from analog photography. Basically, the only thing that has changed is the recording medium – an image sensor is used instead of film. Up to the point in time at which the image is actually recorded, everything's the same, and the same composition rules and optical laws apply to both analog and digital photography. Photography doesn't become digital until the data from the sensor are converted by means of an analog-digital converter.

And the curse or the blessing of this new technology begins no later than precisely at this time. In the case of analog photography, each recording costs real money for film and developing, in addition to which the results don't usually become visible until a week later. This necessitates well planned image composition, deliberate and careful work, and a limited number of recordings due to the costs involved. In the case of digital photography, a recording is assumed to have no costs at all, and it's available immediately. However, these positive aspects often lead to a careless attitude and an overwhelming inundation of images.

In the case of analog photography, flawed images can be corrected to some extent in the lab. This applies to digital photography too, except that a computer with image processing software is used. The same specialized knowledge and the same amount of time and effort are required in order to correct flaws which occur during image recording. However, correction options for achieving good results with a poor recording are limited. Neither ingenious laboratory techniques nor brilliant computer skills are capable of saving an image without any detail at the boundary areas between light and shadow.

The diverse exposure options and extensive information provided by modern camera systems would appear to make external exposure meters superfluous. However, closer examination reveals that this information is only conditionally meaningful for an evaluation of correct exposure.

Integrated exposure meters are limited.

Modern analog and digital cameras always function in accordance with the reflected light metering method, i.e. they measure the light reflected by the subject through the lens, and usually provide several reliable and accurate ways of setting exposure. And thus segmented or matrix metering, center-weighted metering and spot metering come to grips with many of the exposure problems encountered in practical photography, but by far not all of them!

Camera displays are not calibrated.

Visual checking of the exposure setting at a camera display which is not calibrated for brightness and color is only capable of revealing gross exposure errors, even if the display is well adjusted. Outdoors in the sunlight, exposure becomes a game of chance. The image frequently has an entirely different appearance in a calibrated monitor.

Histograms only show the distribution of tonal values throughout the entire image.

The histogram merely depicts the distribution of tonal values throughout the entire image and must be interpreted depending upon the subject, as well as lighting. The photographer needs lots of practice and experience to this end. Only in rare cases does the subject to be evaluated fill out the entire image area, which means that the histogram doesn't say anything about the evaluation of the subject or the segment.

Subsequent exposure corrections are greatly limited and time consuming.

Subsequent correction options available at the computer are time consuming, are incapable of replacing missing detail in highlighted areas and shadows, and represent a direct contradiction to the dynamic workflow associated with digital photography. Post-processing is always equated with the removal of information. If a tonal range which is too small is expanded, information gaps always occur which appear in the histogram as the dreaded "picket fence".

Handheld Exposure Meter as a Sensible Supplement to an Integrated Exposure Meter

Precise, repeatable exposure plays a significant role, and may not be left to chance. Exposure meters which are integrated into the camera function in accordance with the reflected light metering method and only show the correct exposure value if the subject itself reflects 18% of the incident light (gray chart). Handheld exposure meters which also use this metering method are subject to the same limitations, but they offer additional functions as image composition tools which go well above and beyond the possibilities of integrated metering systems. These include precise incident light measurement with spherical or flat diffuser, flash measurement with evaluation of the incident light ratio, differentiated contrast measurement and mean value generation, as well as spot metering independent of focal length and measurement and evaluation in accordance with the zone system.



Better Results with the Incident Light Metering Method

Handheld exposure meters make use of the incident light metering method, i.e. they measure the light which strikes the subject and calculate a more precise exposure independent of the subject's color and reflectivity. This is especially advantageous for primarily bright or dark subjects. In the case of exposure meters with flat diffusers, the otherwise spherical acceptance angle (180°) can be adjusted to a more directional measurement.





Reflected Light Metering –
Camera

Incident Light Metering –
Handheld Exposure Meter

The example white car on white background and black car on black background shows in the pictures above the results of camera internal reflected light metering and handheld exposure meter incident light metering. The camera interprets in both scenes the brightness as neutral gray tone (18% reflection) and exposures wrong because the scenes differ extremely from the neutral gray tone.

Measurement of Drop in Luminous Intensity

Within a spatially distributed subject, the intensity of the light decreases by the square of the distance to the main light source. The closer the main light source is to the subject, the more noticeable is the drop in luminous intensity. With the incident light metering method, exposure can be ascertained at the subject's various depths. The exposure values (EV) can be displayed as a rule at handheld exposure meters, and the difference between the two measured values results in the number of f-stops.

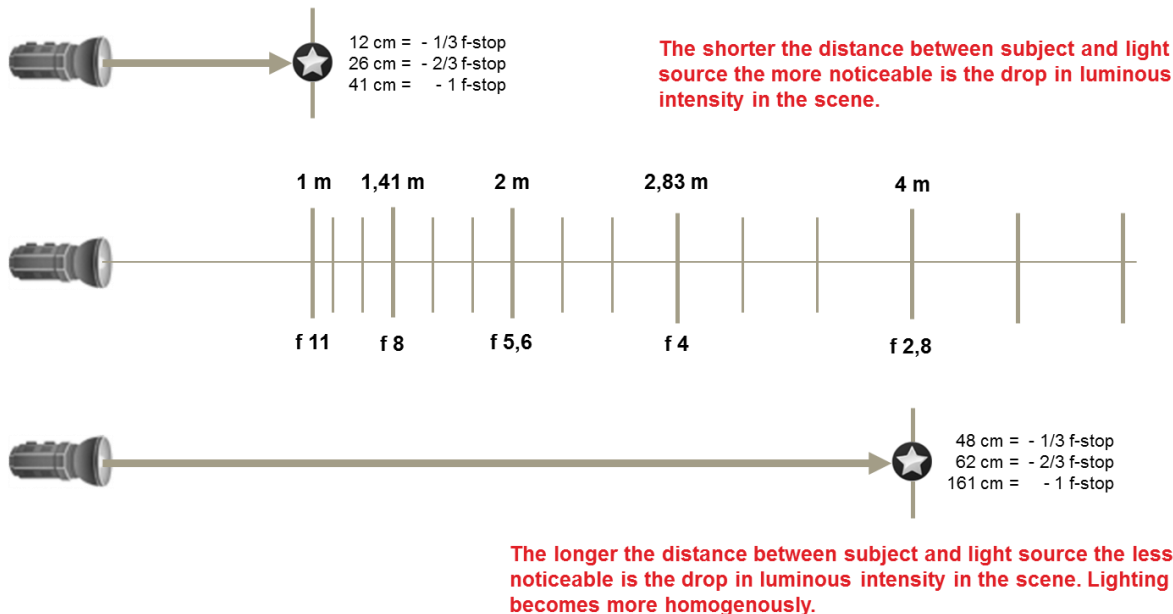

Flash Exposure Measurement in the Studio and Outdoors

Handheld exposure meters usually include a flash exposure measurement, i.e. they measure light from manually operated, compact flash units or studio flash units and ascertain correct exposure based on measurement results. The ratio between ambient light and flash is frequently displayed as well. When buying a handheld exposure meter, make sure that this function is supported!

Adjusting Lighting Contrast in the Studio

In studio photography, lighting contrast is selected depending on the desired visual message and image impact. It can be defined as the relationships which exist amongst key light, fill-in light, edge light and background light. The handheld exposure meter based on the incident light metering method is held at the subject facing the light source to be adjusted, whose power or distance is varied until the desired value is obtained. As a rule, key light is set as a fixed reference value which indicates the intensity of the other light sources as deviation from the reference value in f-stops (EV) with a fixed synchronization speed.

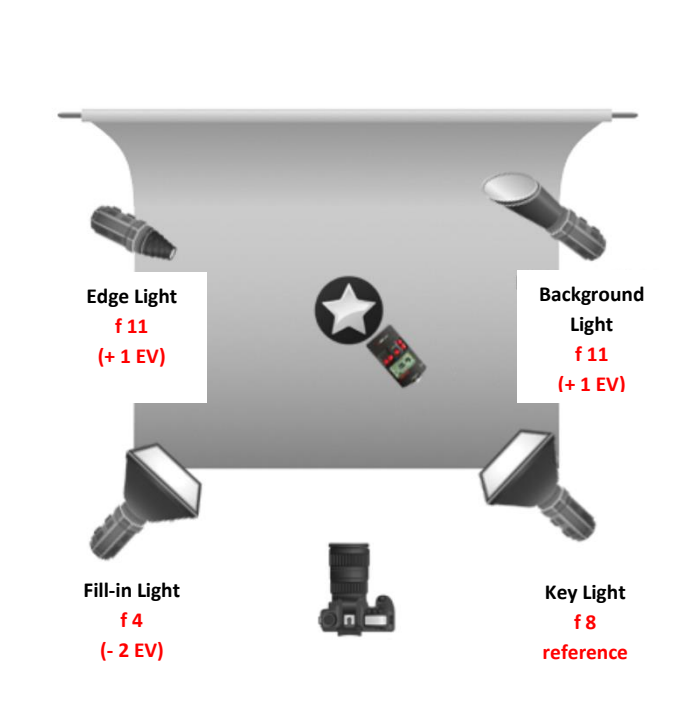

1. Key Light

- Flash power on medium value (adjusting range)
- ISO setting = nominal camera sensor sensitivity
- Synchronizing time = shortest camera setting for flash
- Defining f-stop, measuring and adjustment of flash power until reference value (f-stop) is achieved
- Set reference value on camera and keep it in mind
- All other lights will be set relatively to this reference

2. Fill-in Light

- Low lighting contrast (high-key) reference value – 1,0 EV (f-stop)
- Standard lighting contrast reference value – 2,0 EV (f-stop)
- High lighting contrast (low-key) reference value – 3,0 EV (f-stop)

3. Edge Light

- Reference value + 0.5 to + 1.0 EV (f-stop)

4. Background Light

- Setting dependent on the desired effect
- Bright white background reference value + 1,0 EV (f-stop)

Determining Subject Contrast ¹

Handheld exposure meters can be used to ascertain subject contrast by means of the reflected light metering method. While pressing and holding the measurement key, the exposure meter is pointed at the various brightness values, one after the other, or it scans the entire subject to this end. Some simpler models then either display the f-stop range (smallest to largest f-stop) or, as is the case with the GOSSEN DIGISKY, the exposure value difference (EV, f-stops) is directly displayed and the minimum, mean and maximum values, as well as the associated f-stop / shutter speed combinations, can also be queried – ideal initial values for HDR photography or for adjustment to the contrast range of the image recording medium.

Spot Metering with Fixed Acceptance Angle ¹

As a rule, spot metering with handheld exposure meters uses a fixed, 1° angle of acceptance and is capable of measuring small areas very accurately within a complex scene, and it's also possible to generate a mean value by taking several measurements. As opposed to this, the measuring range for spot metering included with modern reflex cameras is indicated as a percentage of the image area (sensor). The angle of acceptance depends on, and changes along with, the lens's focal length.

Pre-Visualization of the Tonal Values with the Zone System ¹

With the zone system, final visual results can be viewed for creative planning before the image is recorded. Use of an 11-stage zone system makes it possible to evaluate deviating brightness within the subject in consideration of exposure, so that adequate tonal values and detail are present even in the bright and dark areas of the subject in order to ensure exact reproduction. As a standard feature, acquired measurement results correspond to the neutral gray tone (18% reflection) in the zone V tone scale. All of the details which are important for an image recording can then be individually measured on this basis, and their tonal value can be ascertained.

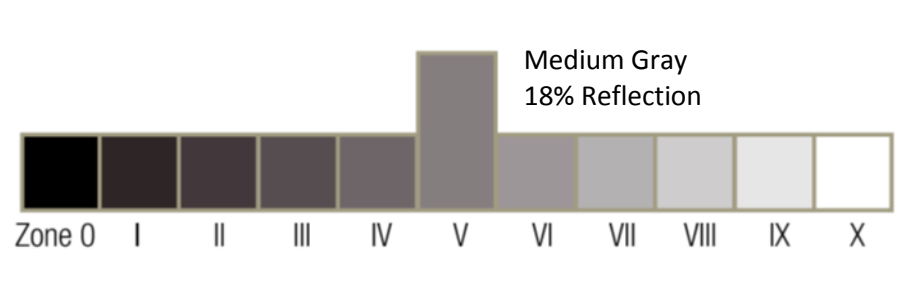

Conclusion

By working with exposure meters in actual practice, photographers become intuitively familiar with the relationships amongst recording sensitivity, exposure time and f-stop, as well as filter factors and correction factors, and learn how these different exposure aspects interact to create ideal results.

This gives rise to the following additional advantages:

- **Correct exposure**, even in unusual situations with regard to subject, lighting and image recording
- **Deliberate, targeted work** instead of tedious trial-and-error experiments
- **Reduced effort and time-savings** for many tasks, especially for flash and studio photography
- **Plannable, measurable and reproducible lighting conditions** assure foreseeable, constant results in the studio
- **More time for photography**, and less time spent on sorting through exposure variants and post-processing at the computer



In light of all of these positive aspects, there can be only one answer to the provocative question asked at the beginning of this article:

Working without a handheld exposure meter is possible, but it hardly makes sense!

¹⁾ Depends on the respective model of the handheld exposure meter

2 Light in Photography

When we speak of light we refer to the range of wavelengths from 380 to 780 nm from the much broader spectrum of electromagnetic radiation, which is designated visible radiation (VIS) and to which the human eye is sensitive.

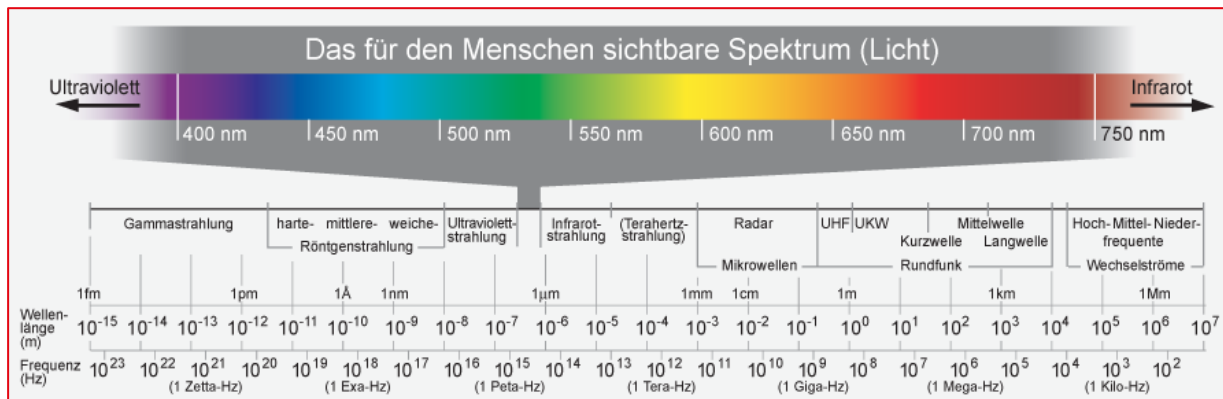

Electromagnetic Radiation Wavelengths and Frequencies

(source: Wikimedia Commons – Horst Frank – Electromagnetic spectrum c.svg)

This is also frequently described as the range of optical radiation from 100 nm to 1 mm, which additionally includes the neighboring, non-visible ranges of ultraviolet and infrared radiation. Depending on the wavelength, ultraviolet radiation penetrates human skin and can tan us (UV-A), but it can also cause sunburn and conjunctivitis (UV-B, UV-C). The conversion of atmospheric oxygen into ozone and germicidal effects (UV-C) are further characteristics. Infrared radiation, which we perceive and take advantage of as warmth, is less dangerous for people.

Visible light is made up of the primary colors red green and blue. The receptors in the human eye can be grouped into three ranges of sensitivity:

- 380 to 450 nm – blue
- 450 to 600 nm – green
- 600 to 780 nm – red

Mixing the primary colors in equal proportions results in the color white.

Additive Color Mixing

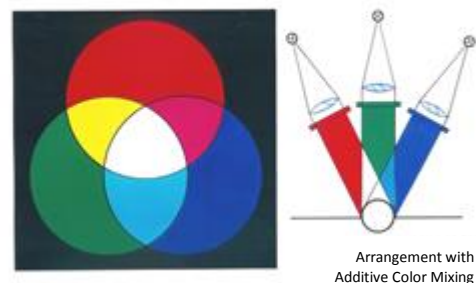

The colors in our environment are the result of subtractive color mixing, i.e. the complementary colors of the primary colors are mixed:

cyan, magenta and yellow.

Mixing the complementary colors in equal proportions results in the color black.

Subtractive Color Mixing

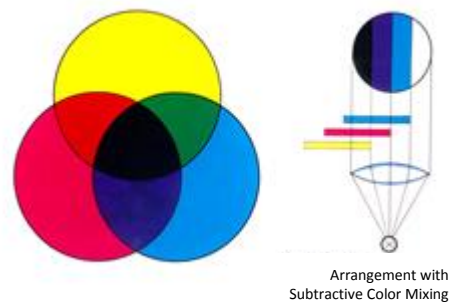

2.1 Color Rendering

The color of an object results from partial reflection of the spectrum emitted by the illuminating light source. If certain ranges are missing from this spectrum, the corresponding color components cannot be reflected or seen. If intensity is not uniform over the entire spectral range, color components with greater intensity are amplified, and those with lower intensity are attenuated. If the spectrum of the incident light is changed, for example through the use of other lamp technologies, the appearance of the colors of the observed object change as well.

The color rendering properties of a light source are defined by means of the color rendering index. Light sources for use in photography should have a color rendering index of significantly greater than 90 and a high R9 value for saturated red.

Spectra of Various Light Sources:

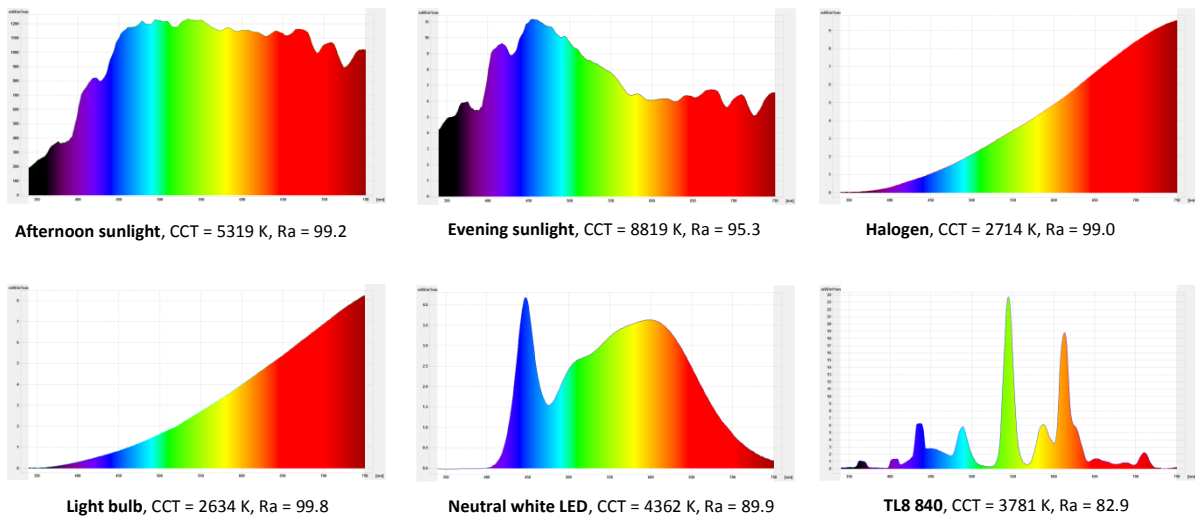

2.2 Color Temperature

The color impression of a light source is defined in terms of color temperature in Kelvin (K). It's defined via the temperature of a black object, the so-called Planckian radiator, and the color of the light emitted by the object at this temperature. When a black object is heated up slowly, it emits radiation in various colors or wavelengths.

Low temperatures of less than 800 K result initially in infrared light, after which the visible color range from dark red to red, orange, yellow, white and blue is traversed and finally invisible ultraviolet light is emitted at above 12,000 K. The temperature at which color balance occurs with the light source under consideration is the light source's correlated color temperature (CCT). It can be measured with a color temperature meter.

2.2.1 Color Temperature Throughout the Day

The color temperature of the light varies greatly during the course of the day and thus influences mood and color rendering. At sunrise and sundown, warm light immerses the landscape in orange or reddish hues. As the day progresses the color temperature increases at first, reaching its apex at midday, and then dropping back off again into the evening.

▪ Sunrise, sundown	2000 to 3000 K
▪ Moonlight	4000 K
▪ Light before 9 a.m.	4800 K
▪ Light from 9 a.m. to 3 p.m.	5400 to 5900 K
▪ Light after 3 p.m.	4900 K
▪ Sunlight, cloudless sky	6500 K
▪ Daylight, overcast sky	7000 K
▪ Cloudy weather	8300 K
▪ Daylight at the seaside, mountains	12,000 to 25,000 K

2.2.2 Color Temperatures of Light Sources

Common lamps have color temperatures ranging from less than 3300 Kelvin (warm white), from 3300 to 5300 Kelvin (neutral white) on up to greater than 5300 Kelvin (daylight white).

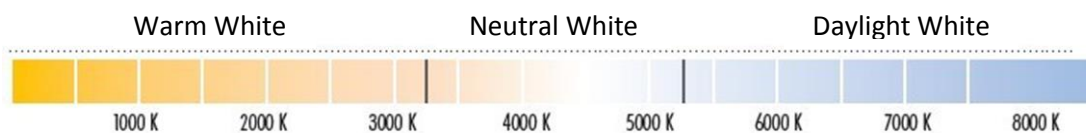

The precise color temperatures of specific light sources are listed below.

▪ Candle and kerosene lamp	1900 to 1950 K
▪ Sodium-vapor lamp (SON-T)	2000 K
▪ Incandescent household light bulb	2100 to 2900 K
▪ Halogen lamp	2700 to 3000 K
▪ Standard light type A	2856 K
▪ Fluorescent lamp, LED (warm white)	3000 K
▪ Type B Nitraphot photo lamp (500 W)	3200 K
▪ Type A Nitraphot photo lamp (500 W)	3400 K
▪ Fluorescent lamp, LED (neutral white)	4000 K
▪ Xenon lamp (standard)	4.600 to 4.800 K
▪ Electronic flash unit	5500 to 5600 K
▪ Xenon lamp (blue)	6000 K
▪ Fluorescent lamp, LED (daylight white)	6500 K

2.3 Light Characteristic – Hard and Soft Light

The terms hard and soft light are often encountered in photography when illuminating an object, although these characteristics do not reflect any actual physical properties of the light. Hard or soft light is simply the result of the **ratio of the light-emitting surface of a source of light to the size of the object**, and is independent of luminous intensity. The following applies in this regard:

*The larger the light-emitting surface relative to the object the softer the light.
The smaller the light-emitting surface relative to the object the harder the light.*

This ratio can be influenced indirectly by varying the **distance of the source of light to the object**. The following applies in this regard:

*The greater the distance between the source of light and the object the harder the light.
The smaller the distance between the source of light and the object the softer the light.*

Whether light is hard or soft is made apparent by the **type of shadows** it casts.

Hard light results in dark shadows with abrupt light to shadow fall-off and clear-cut, sharp edges.

It occurs in the case of sunlight with clear skies, cameras with internal flash and compact flash units. It's generated in the studio by means of snoots, tubes or small standard reflectors. Hard light always occurs when the light-emitting surface is relatively small in comparison with the subject.

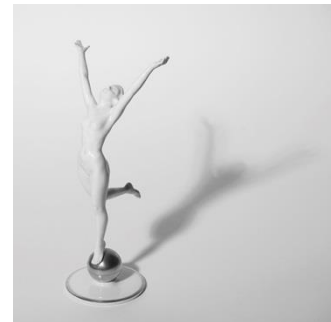

Soft light results in diffuse shadows with soft, unsharp light to shadow fall-off.

It occurs in the case of diffuse sunlight with overcast skies, where diffusers are positioned between the sun and the subject with clear skies, and inside light tents. When compact or studio flash units are used, soft light is generated due to indirect flash via white ceilings, walls, reflective surfaces and reflecting umbrellas, as well as due to direct flash through diffusers, softboxes or translucent umbrellas. The reflection or diffusion surface (light-emitting surface) should have a neutral color and be fully illuminated. Soft light always occurs when the light-emitting surface is relatively large in comparison with the subject.

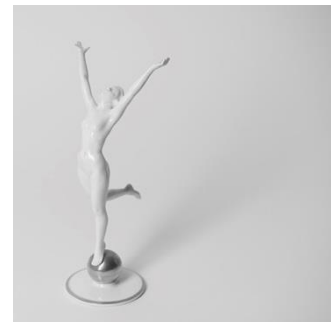

Hard or soft light is used as required depending on the situation – it determines the light effect and underscores the visual message. Hard light is more appropriate in the case of character portraits of men, whereas beauty photographs of women require soft light. The final decision is of course made by the photographer.

2.4 Luminous Intensity – the Inverse-Square Law

The entire luminous flux emitted by a point source distributes itself uniformly in three-dimensional space over the surface of a sphere which becomes larger in proportion to the square of distance r to the source. And thus luminous intensity declines at a rate of $1/r^2$. This relationship is known as the inverse-square law.

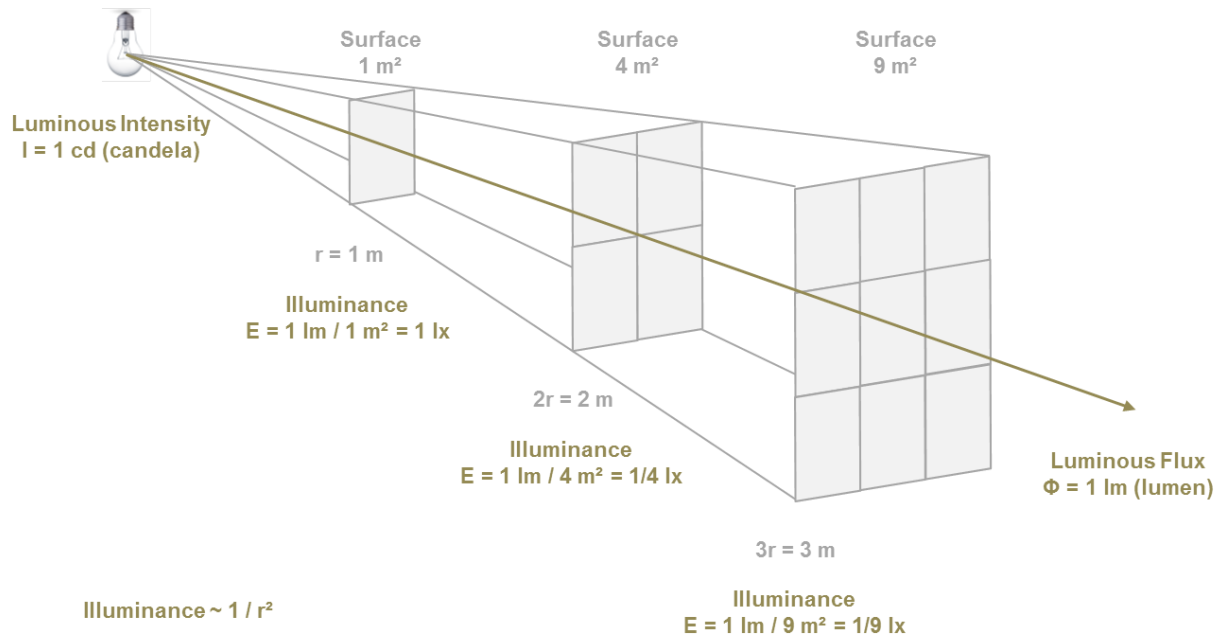

Expressed in simplified terms, this has the following significance in the field of photography:

Luminous intensity is reverse proportional to the square of the distance.

or

*If distance to the light source is doubled,
luminous intensity is reduced to one fourth of its original value.*

Exposure, i.e. the amount of light which strikes the sensor or the film, is controlled by the f-stop setting in the field of photography. If the f-stop setting is reduced by one step, the amount of light is cut in half by definition. The series of f-stops normally printed on the lens is:

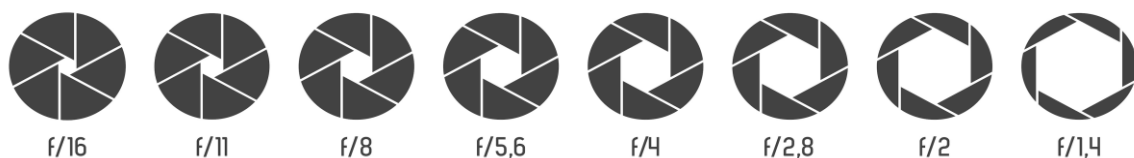

If we now establish the relationship between the distance of the light source to the subject and the f-stop, we obtained the following guiding principle:

*Doubling the distance from the light source to the subject
results in a loss of light which is equivalent to two f-stops.*

Within a spatially distributed subject, luminous intensity decreases by the square of the distance to the main light source. The closer the main light source is to the subject, the more noticeable is the drop in luminous intensity. Exposure can be ascertained at the subject's various depths using the incident light metering method. The exposure value (EV) is displayed as a rule at handheld exposure meters, and the difference between the two measured values results in the number of f-stops.

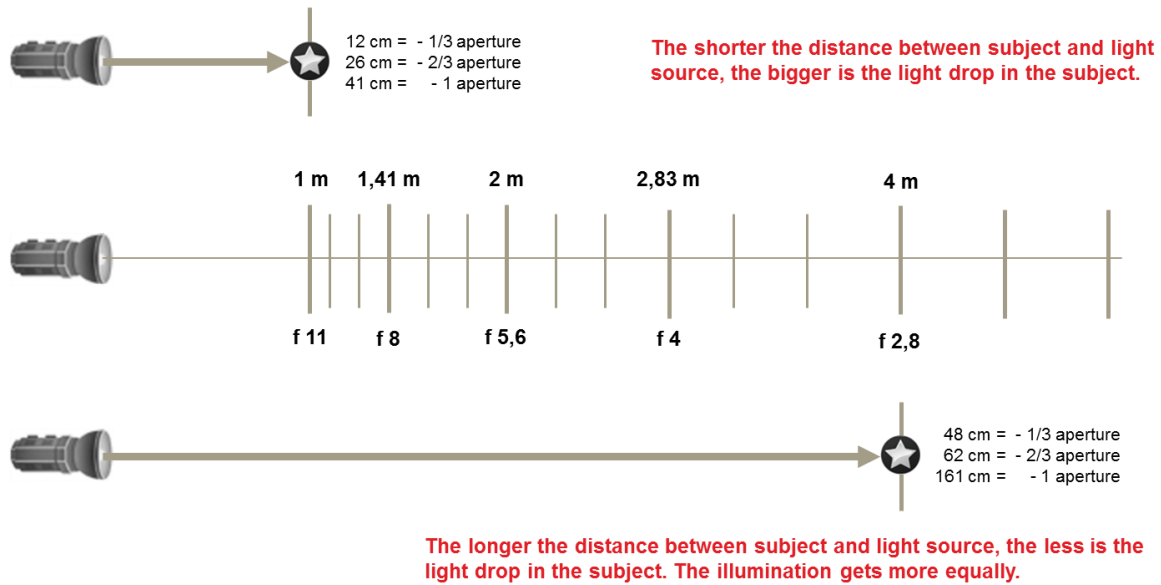











If a softbox is positioned at a distance of 1 m from the subject in order to obtain soft illumination, the photographer has to make sure that the subject doesn't move around too much. If he makes just one step backwards, this results in underexposure equivalent to one f-stop as shown in the example above.

The photographer can also take advantage of this effect. If he positions his light source at a greater distance from the subject he'll end up with less luminous intensity and will have to increase the f-stop setting, but at the same time, the drop in luminous intensity will be less. This effect is advantageous for uniform illumination of subjects with varying depth.

2.5 Influence of Light Shapers

Light shapers not only influence the quality of the light, but rather its quantity as well. And thus each time the light shaper is changed, it's essential to reestablish correct exposure. The following example shows measured f-stop values with constant flash head power at a constant distance.

	7" reflector	f = 10		22" ACW beauty dish	f = 6,3
	7" reflector + honeycomb	f = 8		22" beauty dish + hc	f = 5,6
	9" reflector	f = 14		translucent umbrella 105	f = 6,3
	narrow snoot reflector	f = 5		umbrella white 105	f = 5
	strip light 30 x 120	f = 5		umbrella white 105	f = 5
Flash head 500 Ws, ¼ power, ISO 100, 2 m distance				umbrella flood reflector	f = 8

2.6 Light Direction

Depending on where the light comes from, various photographic effects can be obtained. The following graphics provide a brief summary.

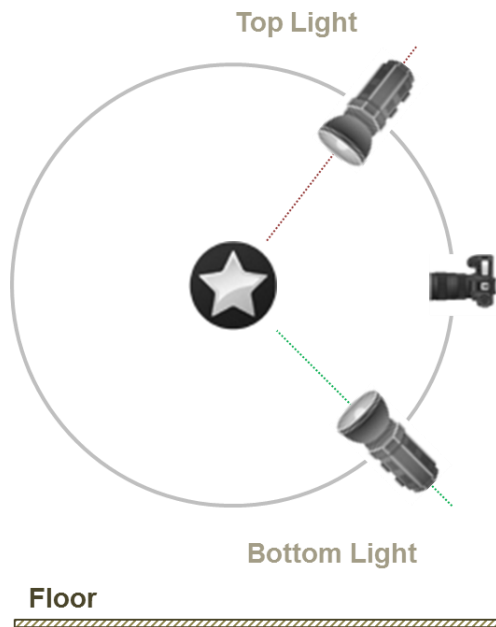

Bottom Light

- Shadows fall upward into the presumably wrong direction
- Effect light for mystical or threatening situations

Top Light

- Light / shadow corresponds to sunlight, natural lighting effect
- Too steep light produces no shadow, boring image results

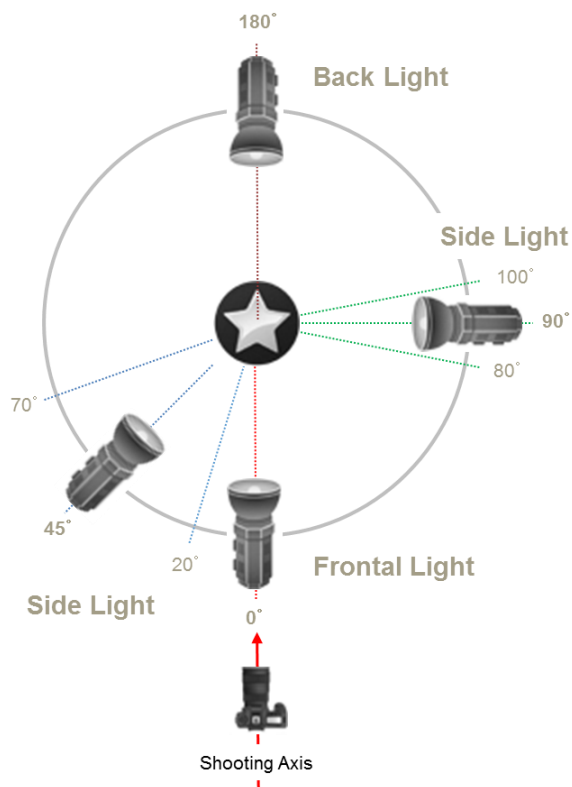

Frontal Light

- uniform illumination without shadows
- boring mood lighting and lack plasticity
- suitable for brightening and contrast compensation

Side Light 45°

- standard in the people photography
- balanced shadows provide plasticity

Side Light 90°

- extreme shadows give plasticity to even flat subjects
- skin blemishes be strongly emphasized

Back Light

- Halos around the subject emphasize the outline
- Use as a hair light, separating the head from the background

3 White Balance

When the colors of an image do not appear genuine, the color of the light (color temperature) has not, as a rule, been correctly matched to the spectral sensitivity of the image recording medium. Subjectively, the photographer is hardly aware of a color temperature change because the human eye conducts white balancing automatically by means of chromatic adaptation. It adjusts the sensitivity of the color-sensitive cells in the retina to this end. A white sheet of paper is perceived as equally white under artificial light or daylight.

Intentional white balance mismatching can be used as a creative tool in the field of photography. The use of indoor film or setting white balance at a digital camera to artificial light or cold light results in a blue color cast in daylight image recordings, which provides architecture photos with an interesting, cold light mood.

3.1 White Balance in Analog Photography

In analog photography, rough white balancing is conducted initially based on the utilized type of film. Selection can be made between daylight film which is sensitized for a color temperature of 5500 Kelvin or indoor film for a color temperature of 3200 Kelvin (type A) or 3400 Kelvin (type B). Fine adjustment of the illumination's momentary color temperature to the utilized film is accomplished through the use of finely graduated correction filters which are selected with the help of a color meter, for example the GOSSEN Colormaster 3F.

Fundamentally, daylight films can also be used for artificial light, but this results in a yellow or orange color cast. This can be compensated for with blue color correction filters.

Blue color correction filters	3200 K ▶ 5500 K	80A or KB15	4.0x	-2.0 EV
	3400 K ▶ 5500 K	80B or KB12	3.0x	-1.7 EV

Indoor films can also be used in daylight, but this results in a blue color cast. This can be compensated for with red color correction filters.

Red color correction filters	5500 K ▶ 3200 K	85A or KR15	2.3x	-1.3 EV
	5500 K ▶ 3400 K	85B or KR12	2.0x	-1.0 EV

The filter factors of the individual color correction filters are disadvantageous, and are especially detrimental when using daylight film in artificial light. Due to the decline of analog photography, indoor film and color correction filters are only available to a very minimal extent in the meantime.



3.2 White Balance in Digital Photography

As opposed to analog photography, white balancing has been greatly simplified in digital photography. The image recorder can be very quickly adapted to changing light situations and the respectively prevailing color temperature. In the case of RAW files, this step can also be performed loss-free with the image processing program after recording. If the image is only saved as a JPEG or TIFF file, it's advisable to conduct correct white balancing in the camera. Subsequent color temperature adjustment is difficult and may result in reduced image quality.

3.2.1 Automatic White Balance

Automatic white balance is usually abbreviated AWB and is used as the default setting for practically all digital cameras. The camera's software analyzes the recorded image and makes its own decision regarding color correction. In the simplest of all cases, the software looks for an image area which is white or nearly white. If no such area is found, it's assumed that the brightest area of the image is neutral gray, and this area is used as a reference for correction. White balancing only becomes problematic and causes a color cast when the brightest area of the image is in color. Unfortunately, the manufacturers don't publish detailed descriptions of the calculations used for automatic white balance.

Generally speaking, automatic white balance functions quite reliably in standard situations but it frequently fails under difficult lighting conditions and in situations involving mixed light sources, especially where different types of light occur at the same levels of intensity. The only solution is to switch over to manual white balance, even if the camera is then no longer able to automatically react to rapidly changing lighting situations.

3.2.2 Manual White Balance with Presettings

In addition to automatic white balance, digital cameras also offer fixed presets for the color temperature of various types of light such as artificial light, fluorescent lamps, flash, daylight, direct sunlight, overcast sky and shadow.



The preset white balance values can often be fine tuned, thus doing justice to the photographer's individual requirements. With some cameras, primarily semiprofessional and professional products, color temperature can be entered directly in Kelvin or selected from a table.

3.2.3 Manual White Balance with Gray Reference

Manual white balance with the help of a neutral gray or white reference object is highly advisable for colored light or mixed light. Using a gray card which is suitable as a reference for digital photography keeps the photographer on the safe side. The frequently referred to sheet of white paper is only suitable under certain conditions, because paper often contains optical brighteners and thus reflects a large blue component, which cannot be detected by the eye. Aside from classic gray cards, other tools are also offered which additionally include black and white, as well as intermediate gradations or gray step wedges. These make it possible to adjust contrast subsequently in the image processing program, assuming that the RAW image recording format is used.

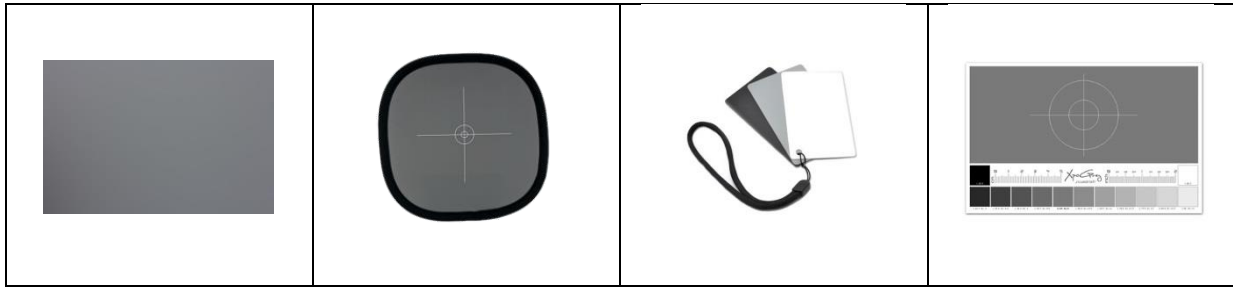

3.2.4 Manual White Balance with White Balance Filter

White balance filters laid out as lens covers or lens covers with special diffusers can be used as an alternative to white balancing with a gray card. The highest quality representative of this species is the ExpoDisc, which is furnished with a calibration certificate. Not only can white balancing be performed with this disc – thanks to calibration, it’s also suitable for exposure metering in accordance with the incident light metering method. When working with these products, one normally faces the main source of light. If this is not possible or if mixed lighting conditions prevail, one can also face the subject and use the reflected light for white balancing.

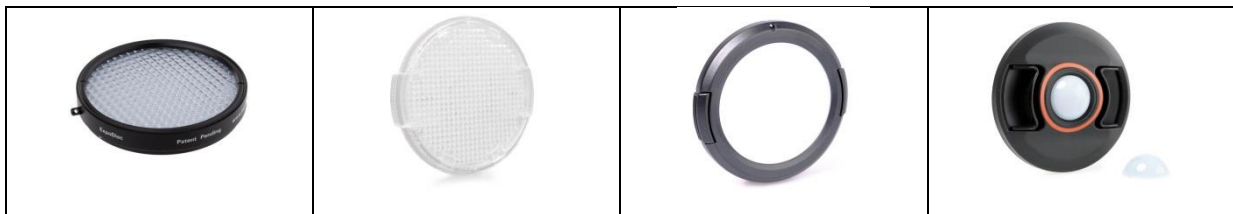

3.2.5 White Balance under Mixed Lighting Conditions

Mixed lighting conditions prevail when several light sources with different color temperatures are active at the same time. This presents the photographer with two different challenges. On the one hand, due to chromatic adaptation of the human eye he’s hardly able to detect the mixed light and, on the other hand, the camera only offers white balance for a single color temperature so that a color cast cannot be avoided in some image areas. There are various approaches to solving this problem.

Avoiding Mixed Light

One should always consider whether or not mixed light can be avoided by switching off or replacing individual light sources. For example, if incident daylight disturbs an artificial light setting and is unnecessary in order to illuminate the scene, photos can be shot in the evening or the windows can be blacked out. This is certainly the simplest solution.

Color Temperature Matching

The color temperatures of the individual light sources can be matched to each other through the use of color filters. The compact flash unit which is pre-matched to daylight and changed to match the color temperature of light bulbs or fluorescent lamps with the help of included filters is a typical example. White balance is then performed based on the uniform color temperature.

Color Matching with Image Processing

Subsequent white balance by means of image processing offers the greatest degree of freedom, but frequently necessitates the most amount of effort as well. In the simplest of all cases, white balancing is based on a single color temperature and the color cast for the other color temperature is partially corrected. A somewhat more complicated procedure involves separate white balancing for the individual color temperatures, each at a given layer, and partial correction by means of merging through the use of a layer mask and opacity. Image recordings in the RAW format are a prerequisite for this after-the-fact procedure.

3.2.6 White Balance and Color Profiling

In the field of product photography, precision color representation is also required in addition to the right white balance. A color profile, which can be integrated into the image processing program and used for all of the images of a given series, is created for the respective combination of light, camera and subject with the help of a color reference table and suitable software.

ColorChecker Passport from x-rite and it's various possible applications are discussed here as an example. Various reference cards are provided in a handy plastic case.

White Balance Reference Card

The spectrally neutral white balance target is used for correct white balancing either in the camera or during post-processing. The user-defined white balance assures a consistent white point throughout a series of images and saves considerable amounts of time as opposed to subsequent correction of individual images.



Classic Reference Card

The classic reference card has 24 color fields, each of which corresponds to a color which occurs in nature and the light reflected by these colors. These include, for example, sky-blue, skin colors and leaf green.



The card, which is photographed along with the subject, can be used either as a visual color reference or as a basis for the creation of DNG profiles with the included Passport software. In this way, the camera's reaction to various lighting conditions can be precisely acquired and automatically applied to all of the images of a given series, thus making it possible – as opposed to manual correction – to obtain accurate, reproducible image results.

Optimization Reference Card

The optimization reference card includes 4 lines with color fields which have been specially developed for uncomplicated post-processing of photos with the pipette.

The two middle lines include warming or cooling fields, by means of which skin colors in portraits can be made warmer, or blue and gray tones in landscape images can be made more intensive.



The bottom line includes HSL fields for hue, saturation and lightness with eight spectrum fields, by means of which the color fidelity of all of the colors of the spectrum can be assured.

The bottom line includes fields which are used as a visual reference for the correction of light and shadow details. The image processing program is frequently capable of restoring overexposed highlights and underexposed shadows, if the corresponding details are still included in the RAW file.

Passport Software









Used together with the classic reference target, ColorChecker Passport software for camera calibration and the plugin for Adobe® Photoshop® Lightroom® permit quick and uncomplicated creation of DNG profiles for Adobe® imaging programs such as Photoshop®, Photoshop® Lightroom®, Photoshop® Elements, Camera Raw (ACR) and Adobe® Bridge.

Regardless of camera or lens make and model, ColorChecker Passport provides the user with a basis for color reference and complete control over the colors. This includes:

- Extended functionality for calibration and color control when using the RAW image format
- Accurate color reference as a basis for creative post-processing
- Elimination of color differences resulting from different cameras and lenses
- Adjustment to mixed lighting
- Color matching of various scenes for a uniform look

3.3 White Balance in the Digital Camera

The following overview depicts white balancing options in the digital camera and provides a recommendation for studio photography.

 Automatic White Balance 3500 K ... 8000 K	 Tungsten 3000 K Shooting at incandescent	 Fluorescent Lamp 2700 K ... 7200 K Shooting under fluorescent lamp, depending on the selected type	
 Direct Sunlight 5200 K Shooting outdoors in direct sunlight	 Cloudy Sky 6000 K Shooting outdoors at cloudy sky	 Shadow 8000 K Shooting outdoors in shadow	
 Flash 5400 K Shooting with integrated or external electronic flash	 Selecting a color temperature 2500 K ... 10000 K Shooting with known color temperature	PRE Manual Preset Determines color temperature from reference object, light source or previous recording	

Recommendation for Studio Photography

4 Fundamentals of Exposure

A subject which is illuminated by ambient light is a basic prerequisite for any image recording. Only in the studio does one have full control over ambient light. In the case of landscape and architecture photography the outdoor lighting situation depends on the time of day and weather conditions. If lighting conditions are unfavorable, image recording has to be postponed to a more suitable point in time. Ambient light can hardly be influenced by the photographer, or only with great effort.

Ideally, the term exposure means that exactly the right amount of light acts upon a light-sensitive medium in order to obtain an optimum image which corresponds to our visual impression. It doesn't matter whether we're working with analog film or digital camera sensors. The amount of light is controlled by the f-stop, i.e. the size of the lens aperture, and duration, i.e. shutter speed. The sensitivity of the image recording medium is specified by the ISO sensitivity rating of the film or sensor.

4.1 The Exposure Triangle

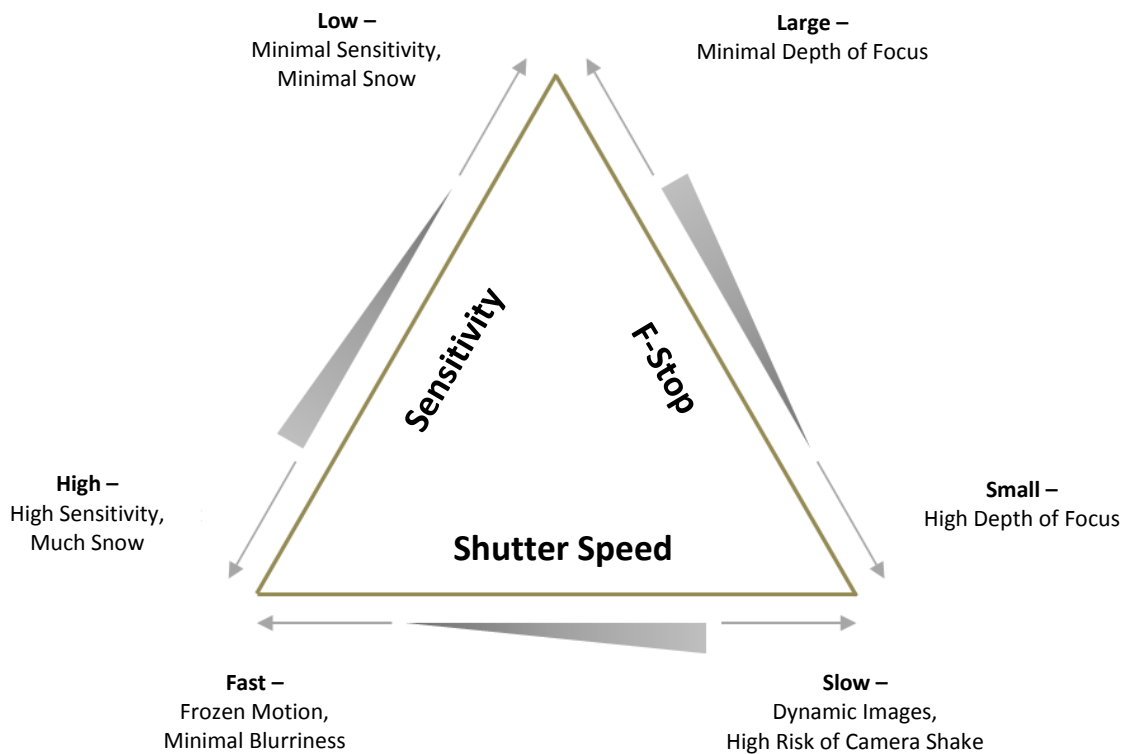

All three factors – f-stop, shutter speed and sensitivity – depend on each other. If one value is changed, at least one of the other two values has to be adjusted in order to obtain an identically exposed image.

4.2 F-Stop

The lens's f-stop controls the amount of light which acts upon the film or the sensor via the aperture. The diameter of the aperture is defined as focal length f / f-stop. In normal daily use only the f-stop is used, i.e. the denominator, which means that a small f-stop corresponds to a large aperture.

The series of f-stops itself is laid out such that the amount of light is either cut in half or doubled from one f-stop to the next, i.e. cut in half from f-stop 4 to f-stop 5.6 and doubled from 4 to 2.8.

This relationship is the result of the aperture. The amount of light is determined by circle area $A = \pi * r^2$, i.e. doubling the surface area of the circle results in twice as much light. The fact that the diameter of the aperture is equal to focal length f / f-stop results in a factor of $\sqrt{2} \approx 1.4141$ for gradation.

Most cameras and lenses make adjustment possible in $\frac{1}{2}$ or $\frac{1}{3}$ stops, thus permitting precision exposure adjustment.

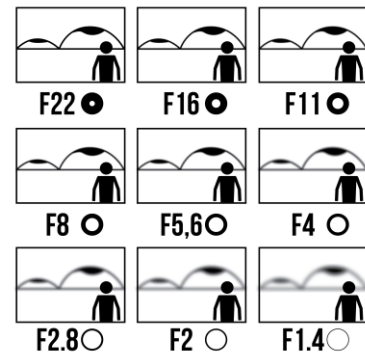

Small f-stop number = large aperture and minimal depth of focus.

Large f-stop number = small aperture and large depth of focus.



High-speed lenses have a large aperture which can be used for cropping objects or to achieve short exposure times. The larger the aperture the smaller the depth of focus. Roughly $\frac{1}{3}$ of the depth of focus is in front of the object and $\frac{2}{3}$ are behind it. A lens delivers maximum depth of focus when it's stopped down roughly 2 to 3 f-numbers. If it's stopped down even further, light diffraction at the aperture blades leads to reduced depth of focus.

4.3 Shutter Speed

The camera's shutter speed controls the amount of time during which light acts upon the film or the sensor. Shutter speed is usually specified in fractions of a second.

The series of shutter speeds itself is laid out such that duration, and thus the amount of light as well, is either cut in half or doubled from one shutter speed to the next, i.e. cut in half from $1/125$ s to $1/250$ s and doubled from $1/125$ s to $1/60$ s.

Most cameras make adjustment possible in $\frac{1}{2}$ or $\frac{1}{3}$ shutter speeds, thus permitting precision exposure adjustment.

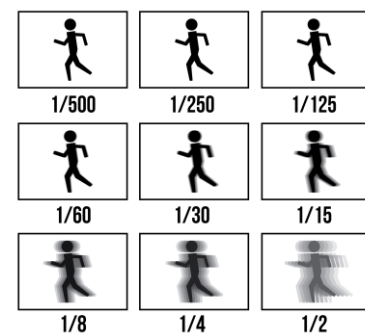



Short exposure times are required in order to avoid blurring in the case of moving subjects or camera shake in the case of greater focal lengths. A long exposure time can also be used as a creative tool in order to make moving subjects such as flowing water or the ocean appear out of focus.

4.4 Shutter Speed / F-Stop Combinations

The amount of light which strikes the film or sensor results from the combination of f-stop and shutter speed. The larger the aperture the shorter the exposure time has to be for a correctly exposed image. Conversely, the smaller the aperture the longer the exposure time has to be where luminous intensity remains unchanged.

And thus there are various possible shutter speed / f-stop combinations for correct exposure where luminous intensity remains constant. For example, combining f-stop 2.8 with a shutter speed of 1/2000 s yields the same result as combining f-stop 4 with a shutter speed of 1/1000 s or 5.6 with 1/500 s.

4.5 ISO Sensitivity

How much light has to reach the film or the sensor for correct exposure depends on its sensitivity, which is usually specified in ISO. Doubling the ISO value results in twice the sensitivity and thus corresponds to one exposure value.

In analog photography, sensitivity is dictated by the utilized film. Film with a low ISO value has a fine grain structure and thus high resolving power. Film with a high ISO value requires a coarser grained structure and thus demonstrates a given degree of graininess.



In digital photography, the sensor's sensitivity to light is also specified as an ISO value, and every sensor has a nominal sensitivity – usually ISO 100. Greater levels of sensitivity can be achieved by means of signal boosting with the camera's electronics and result in more noise. Due to the fact that the ISO value can be set individually for each image recording, digital photography offers a further element for controlling exposure in addition to shutter speed and f-stop.



Best possible image quality is obtained when nominal sensor sensitivity is used. As the ISO value rises, noise increases and image quality declines. As the size of the image sensor increases, and along with it the size of the light-sensitive surface of the individual pixels, more and more light strikes the diode and the sensor becomes more sensitive. Special care is required in the case of automatic ISO settings because the ISO value, and thus image quality, vary from one image recording to the next

5 How does an Exposure Meter Work?

External, handheld exposure meters, as well as exposure meters integrated into the camera, always work in accordance with the photoelectric principle. A light-sensitive sensor transforms the prevailing amount of light into an electrical signal, which is in turn converted into a measured value by the electronic circuitry and the device software.

5.1 Standardization to 18% Gray

All exposure meters, whether external or integrated into the camera, are calibrated to arrive at exposure values which result in images with medium brightness. The gray cards offered by various manufacturers reflect 18% of the image recording light and serve as a reference value for medium gray, as well as for balancing the exposure meter.

5.2 Exposure Value (EV)

Fundamentally, all exposure meters first of all measure the exposure value, from which they determine the f-stop / shutter speed combination required for the photograph. Any given exposure value corresponds to several shutter speed / f-stop combinations, any one of which can be used as desired in order to expose the film or the sensor to the same amount of light.

External light meters usually display the exposure value (EV) in addition to the f-stop / shutter speed combination, thus permitting simple calculation with exposure values, as well as shutter speeds and f-stops as required for contrast measurements, for example. On the other hand, exposure meters integrated into the camera only display shutter speed / f-stop combinations.

The relationship between exposure values and shutter speed / f-stop combinations is shown in the table below for ISO 100/21°. Exposure value 0 is defined such that an exposure time of 1 second results from the settings ISO 100/21° and f-stop 1.0. The exposure value increases logarithmically – doubling illumination intensity increases the exposure value by 1.

EV	2 s	1 s	1/2 s	1/4 s	1/8 s	1/15 s	1/30 s	1/60 s	1/125 s	1/250 s	1/500 s	1/1000 s	1/2000 s
f/32	9	10	11	12	13	14	15	16	17	18	19	20	21
f/22	8	9	10	11	12	13	14	15	16	17	18	19	20
f/16	7	8	9	10	11	12	13	14	15	16	17	18	19
f/11	6	7	8	9	10	11	12	13	14	15	16	17	18
f/8	5	6	7	8	9	10	11	12	13	14	15	16	17
f/5.6	4	5	6	7	8	9	10	11	12	13	14	15	16
f/4	3	4	5	6	7	8	9	10	11	12	13	14	15
f/2.8	2	3	4	5	6	7	8	9	10	11	12	13	14
f/2	1	2	3	4	5	6	7	8	9	10	11	12	13
f/1.4	0	1	2	3	4	5	6	7	8	9	10	11	12
f/1	-1	0	1	2	3	4	5	6	7	8	9	10	11

6 Measuring Methods

Fundamentally, cameras determine exposure values by means of reflected light measurement, i.e. by measuring the light which is reflected by the subject. Depending on the application and the subject, diverse measuring methods can be selected by means of which the various areas of the image are weighted differently in order to obtain best possible measurement results. External exposure meters are preferred for incident light measurement and flash exposure metering. They're also capable of reflected light measurement with specific characteristics. The precise exposure parameters for a single image, or for constant exposure of a series of images, are dictated by the selected measuring method,

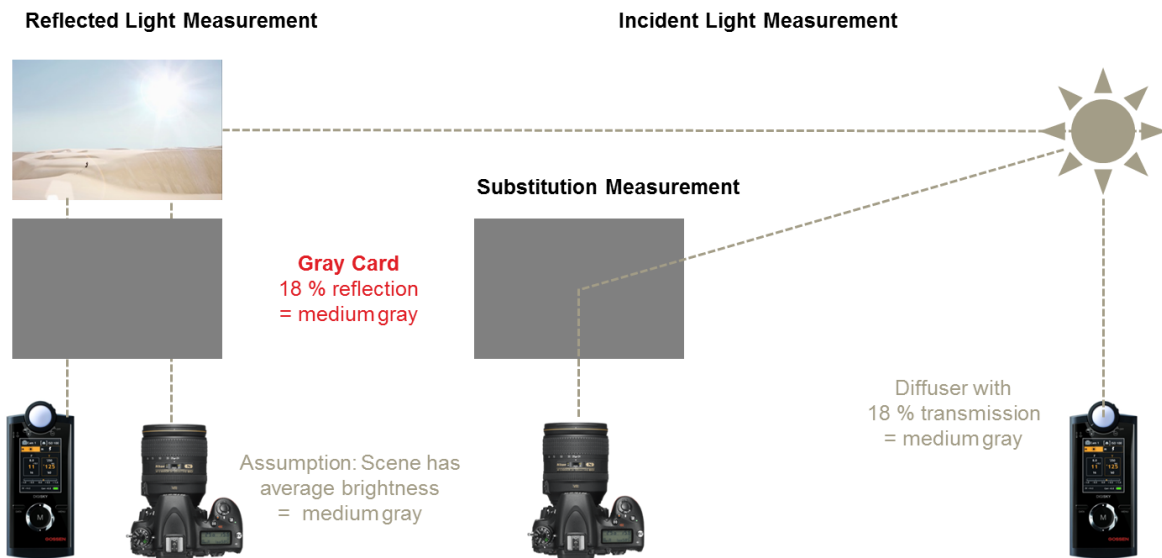

Measurement of the exposure value from which different combinations of shutter speed / aperture arise.

6.1 Reflected Light Measurement

Where reflected light measurement is concerned, the exposure meter acquires light reflected from the subject to the camera at the photographer's position. This value, based on all of the various reflective objects within the image, is used as a tonal value for which required exposure is calculated. Tonal range, color, contrast, background brightness, surface structure and reflectivity of the objects influence the measurement results, although they're not taken into consideration in evaluating the motif.

Monochrome subjects are reproduced in neutral gray with this measuring method. A bright subject reflects more light, and is thus represented as darker. A dark subject reflects less light, and is thus represented as brighter. In other words, if a white and a black car are photographed, both images will depict the same gray car.

Reflected light measurement of a gray chart in close proximity to the subject delivers more precise results, because the gray chart reflects exactly the same light component to which the exposure meter is calibrated. However, this measurement is complicated and in many case impractical.



6.1.1 Average Metering

Average metering takes the entire surface of the image into consideration – the individual areas of the image are not weighted at all. Each of the subject's details makes a contribution to the magnitude of the measurement result depending on its brightness. Due to the considerable inaccuracy of this measuring method, it often results in incorrect exposure and is rarely used.

6.1.2 Center-Weighted Average Metering

Center-weighted average metering is the standard measuring method for numerous reflex cameras and is used whenever the main subject is at the middle of the image and isn't too small, and where only minimal contrast differences prevail. It takes the overall surface of the image into consideration, but as opposed to average metering, the individual image areas are weighted differently. The middle of the image is more significant for exposure, and significance dwindles towards the outside edges. Areas outside of the image circle have nearly no influence at all.



This error-tolerant measuring method is still used frequently today, because incorrect exposure only occurs in the case of just a few subjects, is foreseeable and can be easily corrected by an experienced photographer.

6.1.3 Spot Metering

Spot metering is frequently integrated into modern reflex cameras and is used wherever a small subject area needs to be measured without weighting, or considerable contrast differences prevail. The measuring point is usually in close proximity to the focus area or at the middle of the image, and the measuring range is frequently specified as a percentage of the surface of the image (sensor). The angle of acceptance depends on, and changes along with, the lens's focal length. External spot meters have a fixed, 1° angle of acceptance and are capable of measuring small areas very accurately within a complex scene, and it's also possible to conduct multi-spot metering, i.e. to generate a mean value by taking several measurements.



Spot metering is used when unreliable values are obtained from other reflected light measuring methods, or where incident light measurement is not possible. As a rule, this involves scenes with objects at a great distance, backlighting situations, nighttime image recording, extreme differences in brightness, reflective surfaces or a moving main subject. Special care is required where spot metering is used, because although it's capable of measuring specific parts of the subject in a targeted fashion and thus permits precision work, it can also quickly result in incorrect exposure if the reading is taken at the wrong place.

6.1.4 Selective Metering

Selective metering is exceptionally well suited for taking readings at subject details which are important for the image and are not too small. Despite the small segment of roughly 5 to 10%, which is nevertheless larger than with spot metering which amounts to 1 to 5%, the measured values are weighted so that error tolerance is somewhat higher than with spot metering. The transition from spot metering to selective metering is fluid.

6.1.5 Multi-Segment Metering, Matrix Metering

Multi-segment metering, also known as matrix metering, is today's standard measuring method for modern cameras. It delivers very good results and is first choice for snapshots and action photography.

Calculation models, number and weighting of the segments, as well as the influence of lens specifications such as focal length and focus distance, have developed depending upon the performance level of the camera's electronics. Modern cameras also take color distribution into consideration, or conduct subject detection, both of which influence metering results. Due to a lack of standardization, multi-segment metering varies from one manufacturer to the next, as well as from one camera model to another.

Despite the most up-to-date calculation algorithms, or perhaps precisely due to them, multi-segment metering may result in incorrect exposures which are not however comprehensible and are easy to correct. This can be remedied by means of manual metering with alternative methods. Manual metering is frequently more time-consuming than automatic metering, but in many cases it produces significantly better results.

6.1.6 2-Point Metering

Professional photographers make use of the 2-point metering method. First of all, one chooses the brightest and darkest point of the subject which will still demonstrate detail, assuming that the contrast of the subject doesn't exceed the camera's dynamic range. The f-stop values are determined for both of these points with a fixed exposure time. The f-stop which is at the middle of both measured values is selected for image recording. It must be assured that not the arithmetic mean value between the f-stop numbers is selected, but rather the mean value in the logarithmic f-stop series.

6.1.7 Substitution Measurement with Gray Card

The uncertainty factor associated with reflected light measurement is due to the assumption that the entire object reflects 18% of the incident light. Better results can be obtained if we conduct metering with a substitute object which fulfills these requirements. A gray card with 18% reflectivity is used for this purpose.

In the case of three-dimensional subjects, the gray card is positioned perpendicular to the bisector between the main light source and the camera's axis within the motif, and metering is conducted with the exposure meter at a right angle to the card. The surface of the gray card must not reflect any glare and must not be shaded by any objects.

Due to the fact that in the case of diffuse illumination no definite light direction can be determined, the gray card is held such that it directly faces the camera. In the case of flat artwork, the gray card is always positioned parallel to the plane of the artwork because the brightness of flat artwork is influenced by the exposure angle.

When metering is performed with the camera, it must be assured that the gray card entirely fills out the viewfinder. This is accomplished by temporarily shortening the recording distance, using a telephoto lens, zooming in or alternatively by means of spot metering. If a handheld exposure meter

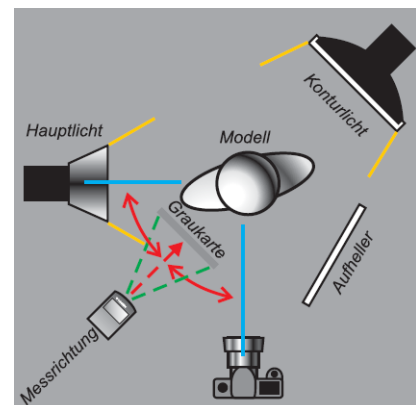

is used, the gray card must fill out the angle of acceptance. This is accomplished by means of a short distance to the gray card or alternative use of a snoot.

If the subject is further away or not easily accessible, metering can be performed alternatively at the camera's location, assuming that similar light conditions prevail here.



The use of a handheld exposure meter with incident light measurement is much simpler than this somewhat complex procedure.

6.1.8 Reflected Light Metering Methods of Cameras

The following table compares the reflected light metering methods of cameras, their advantages and disadvantages, and their respective areas of use.

Measuring Method	Integral	Center-weighted integral	Multi-field, matrix	Spot	Selective
Description	Complete image area weighted equal out of use	image center weighted higher standard function of older analog cameras	complex calculation intelligent weighting subject, lens data, color standard function for modern cameras	approx. 4% of image area, equal weighted	approx. 9% of image area, center spot weighted
Advantage		pre-visible and easy to correct measuring failures	good results, fast working	exactly aiming and measuring of small subject areas	exactly aiming and measuring of small subject areas, higher tolerance
Disadvantage	uncertain		not calculable how value is generated	intolerant against handling failures	
Application		center oriented subjects, portrait photography	moving subjects snapshots, action photography	contrast measurements, high subject contrast backlight glancing subjects night photography low key	backlight glancing subjects night photography low key

6.2 Incident Light Measurement

The incident light measuring method is only possible with external exposure meters and is frequently used by professional photographers. As opposed to reflected light measurement, the light striking the subject is measured instead of the light reflected by the subject. A semispherical diffuser head is attached in front of the sensor to this end, which covers a spherical angle of acceptance of 180° and demonstrates 18% transparency. In this way, the exposure values are derived directly from the incident light regardless of the color, brightness and reflectivity of the subject.

Metering is performed in front of the subject in the direction of the camera, or in the case of three-dimensional subjects with the main source of light in front of the subject, towards the bisector between the camera and the main source of light. In the case of outdoor image recordings, metering can be conducted alternatively at the camera's location assuming that comparable light conditions prevail here.

Some exposure meters make it possible to replace the spherical diffuser with a flat one, or to switch back and forth, thus providing for a more directed characteristic. For example, this is used for metering several sources of light in the studio and adjusting lighting conditions.

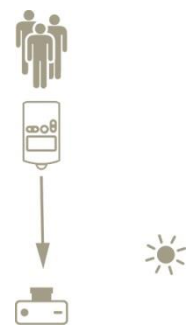

The decisive advantage of the incident light measuring method is the fact that bright objects appear bright in the image and dark objects appear dark.



Reflected Light Measurement, Camera

Incident Light Measurement, Handheld Meter

The example of a white car against a white background and a black car against a black background in the images shown above demonstrates the results of reflected light measurement with the camera and incident light measurement with a handheld meter. For both subjects, the camera sees image brightness as medium gray (18%) and exposes the images incorrectly because the brightness of the subjects deviates significantly from medium gray.

7 Flash Exposure Metering

Where several flash units or a combination of ambient light and flash is used, exposure meters which are integrated into the camera are inadequate, because all of the sources of light which illuminate the scene have to be individually evaluated and added up. External exposure meters are capable of measuring individual flashes, calculating multiple flashes in the event of insufficient flash power and analyzing the ratio of flash to ambient light – even where several sources of light interact with each other.

A second, and much greater benefit, results from using the meter to adjust the lighting conditions of the individual sources of light to each other. This makes it possible to use flash as a creative means, and to set up any desired lighting mood quickly and reproducibly with any flash system and light shaper. Evaluation of the ambient light ratio makes it possible to adjust fill-in flash for outdoor use, or as the main source of light. Tedious experiments with the power settings of individual flash units are thus a thing of the past.

7.1 Adjusting Studio Lighting – Lighting Contrast

One often works with several sources of light in the studio, of which at least one is main light. As a rule, the other sources of light are only used to brighten up the shadows on the subject, as special effect light for the contour or the hair of the model or to emphasize an object's structure, surface or material, or to define a brightness curve for the background.

Lighting contrast is selected depending on the desired visual message and image impact. It can be defined as the relationship which exist amongst main light, fill light, special effect light and background light. The handheld exposure meter based on the incident light metering method is held up at the subject facing the light source to be adjusted, whose power or distance is varied until the desired value is obtained. As a rule, main light is set as a fixed reference value which indicates the intensity of the other light sources as deviation from the reference value in f-stops (EV) with a fixed synchronization speed.

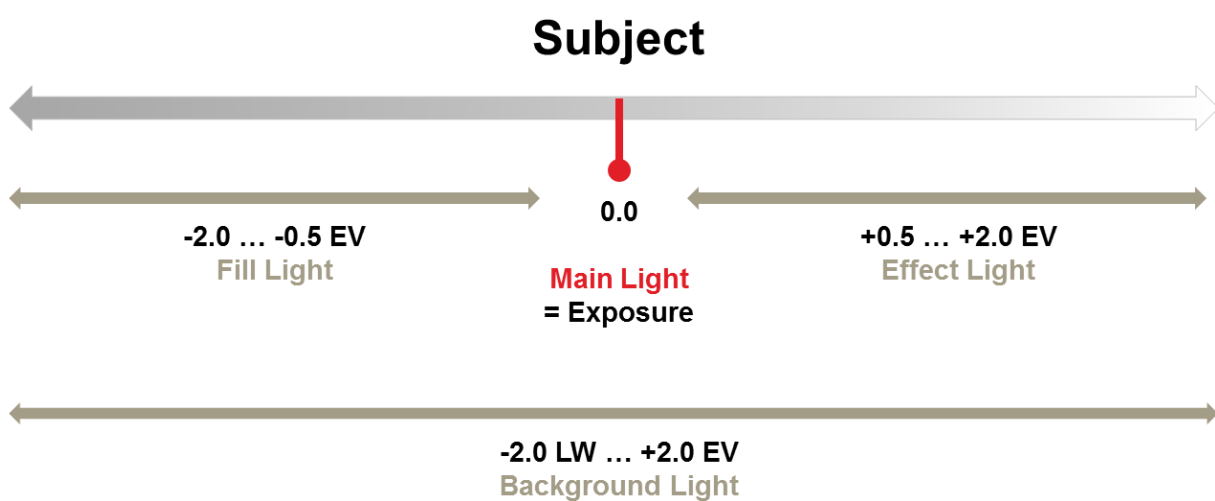

Depending on the desired effect!

The following graphic shows the adjustment of lighting contrast based on the example of a lighting arrangement and provides additional information for camera settings.

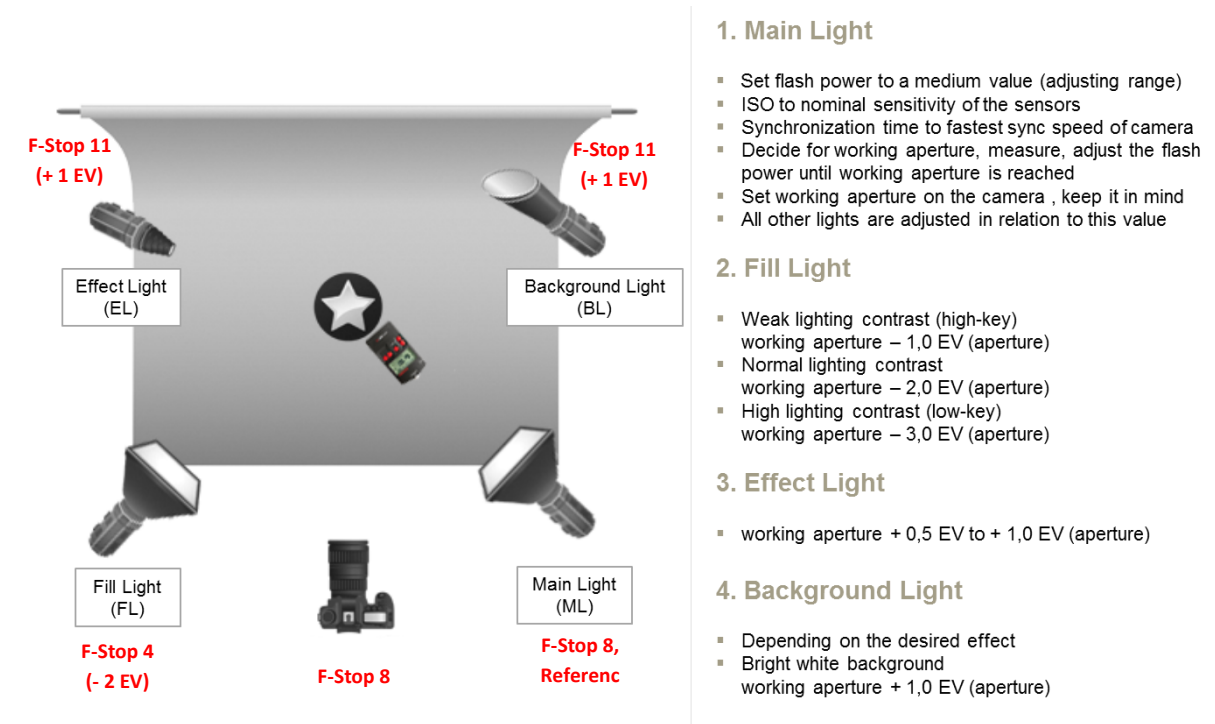

The following graphic shows examples of the results of the exposure settings and their variants.



7.2 Triggering the Flash Unit with the Camera

Triggering of the flash unit must be synchronized with the camera's shutter release button so that the film or the sensor is exposed to flash with fully open shutter. The shortest synchronizing time for common cameras is usually somewhere between 1/125 s and 1/250 s. The exact value for the respective camera model can be found in the operating instructions.

Triggering is simplest with the help of a synchronizing cable which is connected between the synchronizing socket at the camera or a flash shoe adapter and the flash unit to be triggered. However, use of this method is restricted because it limits the photographer's freedom of movement and may lead to damage of the equipment.



Wireless flash triggering kits are the most elegant, universal and safest solution for triggering flash units. A kit usually consists of a transmitter which is mounted to the camera and a receiver which is plugged into the synchronizing socket at the studio flash unit. The other studio flash units can either be triggered by the normally integrated photocell, or more elaborately equipped with a separate wireless receiver. The second method is preferable for outdoor applications, because optical triggering doesn't work in this case. Some flash manufacturers integrate wireless receivers into their flash heads by means of which power control and subdivision into groups (main light, fill light, affect light and background light) is also possible for separate as well as common triggering.



7.3 Triggering and Metering with the Exposure Meter

The simplest type of metering is conducted in the exposure meter's non-cord mode. Metering is started in the flash mode by pressing the metering key and the flash unit is triggered by a wireless transmitter – either as a separate unit or attached to the camera. The exposure meter detects the light pulse, measures the value and displays the result. The desired sensitivity and synchronizing time must be set at the exposure meter.

The second option involves connecting the exposure meter to the system via a synchronizing cable. When the metering key is pressed, the flash unit is triggered automatically and the measured value is displayed. The exposure meter's synchronizing socket can also be connected to a wireless triggering device instead of the synchronizing cable. In this case, the flash unit is triggered by means of a radio signal when the metering key is pressed. Flash head power can also be controlled by the wireless triggering device, if this function is supported.

The most elegant solution is an exposure meter with already integrated wireless transmitter, for example the DIGISKY from GOSSEN. Triggering the flash unit, metering and adjusting flash power are all possible with a single device in this case. There's no need to actually go to the flash head in order to adjust power. As a prerequisite, the exposure meter has to support the flash unit's wireless protocol or the flash unit has to be equipped with a wireless receiver which is supported by the exposure meter. The DIGISKY currently supports flash units from Elinchrom and Broncolor, as well as their wireless triggering kits, and wireless triggering kits from Phottix and the Calumet Pro series.



7.4 Combining Flash and Continuous Light

Flash is frequently used for fill-in together with continuous light in order to brighten up shadows or to obtain more brilliance and color saturation with diffuse illumination. TTL flash control included

with modern cameras supports this application for matching system flash units, but the results are usually incomprehensible to the user and can't be significantly influenced. The resulting images often appear over-flashed or unnatural.

The user has full control when the process is manually controlled. Determination of correct exposure and the flash-to-daylight ratio is very simple. Background exposure is determined first and entered to the camera. It must be assured that the selected exposure time is not shorter than flash sync time. The second step involves the measurement of flash from the surface of the subject which needs to be brightened using the flash exposure meter in the incident light mode. Flash unit power or distance is adjusted such that the measured f-stop is roughly 1 to 2 steps (EV) below the value set at the camera.



If the specified f-stop needs to be opened up further in order to achieve the desired image impact, either a lower sensitivity setting can be selected at the camera or a neutral-density filter can be used to weaken main light. This effect influences fill-in flash to just as great an extent, which has to be taken into account during measurement by entering a correction value at the exposure meter.

External exposure meters frequently provide us with information concerning the flash or continuous light component. For example, GOSSEN's SIXTOMAT F2 and DIGIPRO F2 exposure meters indicate f-stop 16 and shutter speed 1/60 s at the digital display for the combination of flash and continuous light. This value of 16 appears as a blinking marker in the analog f-stop display, and f-stop 8 appears additionally as an continuous, active marker for the continuous light component.

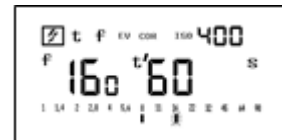

The flash component is displayed at the DIGISKY for GOSSEN as a percentage, for example. The relationship between flash and continuous light can be influenced by changing synchronization speed. This is interesting for brightening up with flash, or when continuous light is not desired. If the flash unit is powerful enough, images with a dark background can also be recorded in daylight. In order to adjust synchronization speed, it may be necessary to work with a neutral-density filter which correspondingly weakens the daylight component.

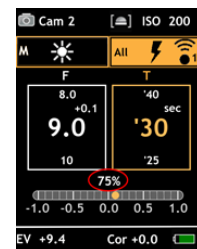

When flash is used, the continuous light component is controlled by synchronizing speed.

8 The Zone System

The zone system was developed by Ansel Adams in order to obtain ideally printable negatives from the analog photography process with the film materials available at that time, which demonstrated a limited contrast range, by controlling developing time. During the course of time the zone system has lost in significance for the development of analog film materials because, on the one hand, negatives were no longer developed individually but rather in rolls and, on the other hand, because modern film and printing paper can handle a larger contrast range.

In the age of digital photography, the contrast range can be selected and final visual results can be viewed for creative planning before the image is recorded with the help of the zone system.

Use of an 11-stage zone system makes it possible to evaluate deviating brightness within the subject in consideration of exposure, so that adequate tonal values and detail are present even in the bright and dark areas of the subject in order to ensure exact reproduction.

As a standard feature, acquired measurement results correspond to the neutral gray tone (18% reflection) in the zone V tone scale. All of the details which are important for an image recording can then be individually measured on this basis and allocated to the respective zone.



Definitions According to Ansel Adams

Shadow zones

I	Nearly black	Blackening without detail, noticeable differences to zone 0
II	Gray-black	Insinuated detail, very dark shadows, black clothing, black textiles, dark pine forest in shadows
III	Very dark gray	Shadows with detail, forest in sunlight, moist earth

Medium gray tones

IV	Dark gray	Dark foliage and grass, stone, woodwork, shadow zones in portraits, sky with red filter
V	Neutral gray or medium gray	Gray values with 18% reflection, gray card, average detail in wood, stone, dark skin colors
VI	Light gray	Light skin color, bright blue sky, light colored stone, shadows on snow in sunlight

Bright zones

VII	Very light gray	Very light skin colors, bright textiles, snow with light from the side
VIII	White with detail	Brightest parts of the subject which still show detail, snow with detail, highlights on skin
IX	White	Polished surfaces without detail, snow with sunlight from the front

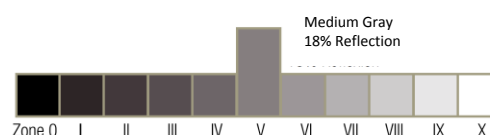

9 The Histogram

The histogram depicts the static distribution of an image's tonal values. Relative to brightness, the camera arranges all of the pixels along a horizontal scale from 0 (black) to 255 (white). The height of the individual line indicates the number of pixels of identical brightness. The fine lines which are very close to each other may result in a gentle curve, a jagged mountain, a picket fence or a combination of any two or all three.

All of the following three images are correctly exposed, underneath which the associated histograms are included.

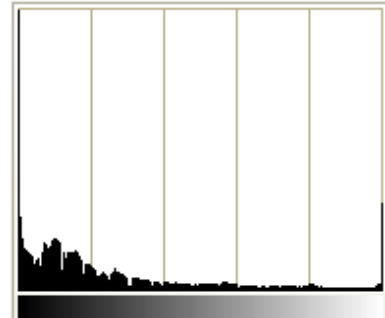
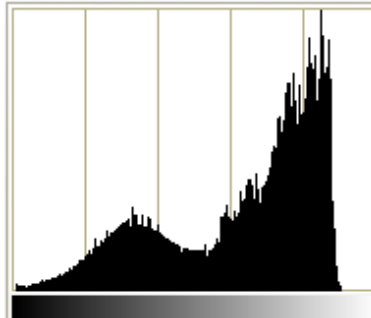
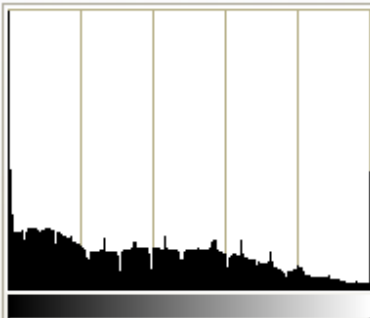

It's apparent that a histogram provides information regarding the distribution of tonal values within the image, but does not offer any indication of lighting conditions, the ambient light to flash ratio or even whether or not the image is correctly exposed.

10 Controlling Contrast

Exposure metering only makes sense if contrast is also taken into consideration, which is decisive for rendering of the tonal values.

Object contrast depends entirely on the material of the subject to be photographed and is independent of lighting. It indicates the ratio between the point with the most and the point with the least reflectivity.

Lighting contrast is the maximum difference between illumination intensity measured at different sides of the subject.

Subject contrast is the combination of object contrast and lighting contrast. It designates the ratio between the brightest and the darkest portions of the subject which are important to the image. This is ascertained by means of close-up or spot metering and is specified in exposure values or f-stop steps. One exposure value is equal to one full f-stop.

If subject contrast exceeds the **dynamic range** of the recording medium, i.e. the total number of brightness levels which the medium is capable of reproducing, the bright or dark parts of the subject appear showing no detail and cannot be improved by means of post-processing.

Overview of Dynamic Ranges of Various Recording and Reproduction Media

Recording Medium		Dynamic Range [EV / f-stops]
Digital reflex camera	100 ASA	10
	400 ASA	9
Digital compact camera	100 ASA	8.5 ... 9
	400 ASA	7.5
Black-and-white negative film		11 ... 13
Color negative film		8 ... 10
Color transparency film (slide)		6 ... 8

Reproduction Medium	Dynamic Range [EV / f-stops]
Standard monitor	8 ... 10
Digital projector	9 ... 12
Slide projector	8
Photo paper	4 ... 6
Photo printer	5 ... 8

Fundamentally, differentiation can be made amongst three situations. Subject contrast is less than, equal to or greater than the dynamic range of the recording medium.

If subject contrast is less than the dynamic range of the recording medium, elbowroom is available in the case of correct exposure. If the average value between the brightest and darkest points is used for exposure metering, average brightness can be shifted in both directions without losing detail.

If subject contrast is equal to the dynamic range of the recording medium, precise exposure is required because any shifting inevitably leads to a loss of detail.

If subject contrast is greater than the dynamic range of the recording medium, the range of tonal values can no longer be imaged. Correct exposure is no longer possible. If the average value between

the brightest and darkest points were used for exposure metering, detail would be lost in the dark as well as the bright areas. Depending on subject and image impact, the photographer would then have to decide which tonal values are most important and adjust exposure if necessary.

Use of the Available Dynamic Range – Optimized Workflow

Metrological analysis of both illumination and the subject make it possible for the photographer to take ideal advantage of the available dynamics range of the recording sensor and the output media, right from the very start. Adaptation by means of tedious post-processing is unnecessary, and the fast-paced workflow associated with digital photography remains unimpeded. Suitable measuring functions include:

- Contrast measurement:** Subject contrast from the brightest to the darkest areas of the subject with detail
- Averaging:** Mean value based on measured values from important areas of the subject
- Zone measurement:** Assignment of brightness values to defined gray values

11 Recommended Reading

Books

Das Blitz-Kochbuch

Kreative Blitzfotografie in der Praxis

Andreas Jorns

dpunkt Verlag, ISBN 978-3-89864-773-1, www.dpunkt.de

Belichtungsmessung

korrekt messen richtig belichten

Adrian Bircher

Verlag Photographie, ISBN 3-933131-59-6

Fotografieren im Studio

Das umfassende Handbuch

Michael Papendieck, Galileo Design, ISBN 978-3-83621-984-6

Portraits fotografieren im Studio

Schritt für Schritt erklärt: perfektes Licht im Studio

Stephanie Eckgold, Frank Eckgold, Galileo Design, ISBN 978-3-83621-649-4

Free Leaflets

Hensel Lichtformervergleich

Hensel Light Guide

www.hensel.eu/lichtformervergleich/



GOSEN Foto- und Lichtmesstechnik GmbH | Lina-Ammon-Str. 22 | 90471 Nürnberg | Germany
Tel: + 49 (0) 911 8602 - 181 | Fax: +49 (0) 911 8602 - 142

www.gossen-photo.de