

ENERGYMID

Multifunctional Energy Meters

EM2281/EM2289/EM2381/EM2387/EM2389

3-349-867-03
8/9.22

- Professional energy meters for 2, 3 and 4-wire systems with 5 (80) A direct or 1 (6) A transformer connection (also includes 5(6) A)
- Accuracy class B for industrial and commercial use, as well as for household use with highly demanding requirements
- Cost savings thanks to initial calibration at the factory in accordance with MID, conformity assessment procedure modules B and D
- Configurable, multifunctional variants for acquiring reactive energy and mains condition variables
- 4 quadrant measurement (import and export)
- Universal pulse output (double) with adjustable pulse rate and pulse duration, as well as selectable voltage range
- Communication via integrated interfaces: LON-Bus, M-Bus-, Modbus RTU, TCP/IP (Modbus TCP, HTTP, BACnet)
- 4 tariffs (hardware-controlled as standard feature), plus 4 additional tariffs (software controlled) with bus (features W1 ... W7)
- Certified meter reading profile in accordance with PTB-A 50.7 and PTB-A 50.7-1 secures your EEG levy privileges (feature Z2)
- Indication of installation errors: phase sequence, phase failure, reversed transformer polarity, overload
- Tamper-proof cover, configuration disabling
- Quality product made in Germany

(Product characteristics are model and feature-dependent. See this document.)



Feature P9

LONWORKS®

M-Bus

ASHRAE BACnet™

Ethernet

Modbus

Applications

The MID** certified energy meter included in the ENERGYMID product range is used to acquire and bill active energy in industrial, household, commercial and building management applications.

Integrated 4-quadrant measurement permits measurement of energy input and output. 4 tariffs (hardware-controlled as standard feature) and, depending on model or version, 4 additional tariffs (software-controlled) can be selected.

In combination with national approval of the integrated meter reading profile (Z2) in accordance with PTB-A 50.7, this energy meter is also suitable for fulfilling legal energy requirements such as the delimitation of third-party quantities in accordance with the EEG (German renewable energy law).

Energy data are transmitted to superordinate management systems via modern communication interfaces, e.g. for acquisition and optimization, as well as for building automation and control technology.

Thanks to simple installation including detection of connection errors and flexible configuration options, it performs all measuring tasks highly proficiently.

Simply and conveniently specify the technical characteristics and other functions (e.g. pulse output, bus connection type and meter reading profile) for your ENERGYMID energy meter via configurable features when placing your order – you get an individualized, device-specific variant which is perfectly matched to your needs.

Multifunctional Version

Depending on the type of multifunctional variant, the meter is also capable of acquiring reactive power and indicating up to 33 additional measured quantities directly at the display.

As a result, voltage level, utilization of individual phases, reactive power component and the functioning of compensation systems can be evaluated at any time by simply pressing a button without any additional measuring equipment. Refer to the table below for details.

Measuring Function	Accuracy (ref. cond.)	Display (feature)			
		M0	M1	M2 ²	M3 ²
Measured Quantity					
Active energy (kWh) ¹	EP ₁ ... EP ₈ , EP _{tot}	•	•	•	•
Reactive energy (kVArh) ¹	EQ _{tot}	—	—	•	•
Star voltage (V)	U _{1N} , U _{2N} , U _{3N}	—	•	—	•
Delta voltage (V)	U ₁₂ , U ₂₃ , U ₁₃	—	•	—	•
Current per phase (A)	I ₁ , I ₂ , I ₃	—	•	—	•
Neutral conductor current (A)	I _N ³	—	•	—	•
Active power (kW)	P ₁ , P ₂ , P ₃ , P _{tot}	—	•	—	•
Reactive power (kVAR)	Q ₁ , Q ₂ , Q ₃ , Q _{tot}	—	•	—	•
Apparent power (kVA)	S ₁ , S ₂ , S ₃ , S _{tot}	—	•	—	•
Power factor (cosφ)	PF ₁ , PF ₂ , PF ₃ , PF _{tot}	—	•	—	•
Frequency (Hz)	f	—	•	—	•
RMS distortion value	THD U ₁ , U ₂ , U ₃	—	•	—	•
	THD I ₁ , I ₂ , I ₃	—	•	—	•

¹ Total power (kW/kVAR) appears at auxiliary display 2 with plus or minus sign

² Not approved for billing purposes in Switzerland

³ The greatest current value per phase is used as a reference value for accuracy.

* Source: ASHRAE – bacnet.org

** Directive 2004/22/EC on measuring instruments

ENERGYMID

Multifunctional Energy Meters

EM2281/EM2289/EM2381/EM2387/EM2389

Applicable Regulations and Standards

Directive 2014/32/EU of the European Parliament and of the Council of 26 February 2014 on the harmonisation of the laws of the Member States relating to the making available on the market of measuring instruments (revision) text with EEA relevance	
DIN 43856	Electricity meters, tariff time switches and ripple control receivers; connection diagrams, terminal marking, circuit diagrams
DIN 43880	Built-in equipment for electrical installations; overall dimensions and related mounting dimensions
DIN 46200	Current carrying connection bolts up to 1600A; design and assignment of current intensities
EN 50470-1	Electricity metering equipment (a.c.) – Part 1: General requirements, tests and test conditions – Metering equipment (class indexes A, B and C)
EN 50470-3	Electricity metering equipment (a.c.) – Part 3: Particular requirements – Static meters for active energy (class indexes A, B and C)
EN 55022	Information technology equipment – Radio disturbance characteristics – Limits and methods of measurement
EN 60529	Test instruments and test procedures – Degrees of protection provided by enclosures (IP code)
EN 61326-1	Electrical equipment for measurement, control and laboratory use – EMC requirements – Part 1: General requirements
EN 62052-1	Electricity metering equipment – General requirements, tests and test conditions – Part 11: Metering equipment
EN 62053-23	Electricity metering equipment (a.c.) - Particular requirements – Part 23: Static meters for reactive energy (classes 2 and 3)
EN 62053-31	Electricity metering equipment (a.c.) – Particular requirements – Pulse output devices for electromechanical and electronic meters (two wires only)
EN 62056-61	Electricity metering – Data exchange for meter reading, tariff and load control – Part 61: Object identification system (OBIS)
PTB-A 50.7	Requirements for electronic and software-controlled measuring instruments and ancillary equipment for electricity, gas, water and heat
PTB-A 50.7-1	Software requirements for measuring instruments and ancillary equipment according to PTB-A 50.7 equipment class 1: Simple instrument

Technical Data

Some of the technical data are model and feature-dependent: device type and (optional) order features are selected when ordering. See also "Order Information" on page 5. All options are listed with corresponding identification in the following tables.

Device Characteristics

Connection	EM2281, EM2289: direct EM2381, EM2387, EM2389: via transformer
Measurement type	4-quadrant measurement
Multifunctional Version	Optional: U, I, P, Q, S, PF, f, THD, I _N (M1) / Reactive energy (M2) / U, I, P, Q, S, PF, f, THD, I _N , THD, I _N , Reactive energy (M3) ¹⁾
Meter reading profile	Optional: Meter reading profile (Z1) / certified meter reading profile PTB-A 50.7 (Z2)
Approval	MID (conformity assessment procedure modules B and D) Optional: additional calibration certificate (P9)
Accuracy class	B for industrial and commercial use, as well as for household use with highly demanding requirements

¹⁾ Not approved in Switzerland

Measuring Ranges

Voltage		
Reference voltage U _n AC	U3:	100 ... 110 V L-L
	U5:	230 V L-N
	U6:	400 V L-L
	U7:	500 V L-L
Allowable deviation	-20% ... +15%	
Current		
	Direct Connection	Transformer Connection
I _{ref}	5 A	1 A
Starting current	20 mA	2 mA
I _{min}	0.1 A	0.01 A
I _{max}	80 A	6 A
Frequency Range		
Nominal frequency	50 Hz	
Cutoff frequency	45 Hz ... 65 Hz	
Accuracy		
Active energy	Class B per EN 50470-3	
Reactive energy	Class 2 per EN 62053-23	
Sampling Rate		
	Continuous, 32 per period	

Current and Voltage Ranges

Input voltage (reference voltage U _n AC)	EM2281:	230 V L-N (U5)
	EM2289:	400 V L-L (U6)
	EM2381:	230 V L-N (U5)
	EM2387:	100 ... 110 V L-L (U3) / 400 V L-L (U6) / 500 V L-L (U7)
	EM2389:	100 ... 110 V L-L (U3) / 400 V L-L (U6)
Nominal current (current limit value)	EM2281, EM2289: 5 (80) A EM2381, EM2387, EM2389: 1(6) A (including 5(6) A)	

Meter parameters and meter readings are retained in the event of power failure.

Power Consumption and Power Supply

Total	Single-phase: < 2 W (at nominal voltage) 3-phase: < 2 W (at nominal voltage) (where line frequency = 45 ... 65 Hz)
Internal power supply	From measuring voltage U: 80 to 115% U _r 3.3 V / 100 mA With W4: 3.3 V / 200 mA (plus 100 mA for Ethernet)
Voltage path, total (including supply):	< 2 VA
Per current path	At I _{max} : < 1 VA for direct meter / < 0.2 VA for transformer meter At I _{ref} : < 0.02 VA for direct meter / < 0.005 VA for transformer meter
Starting current	Direct meter: approx. 17 mA at 0.1 - 5(80) A Transformer meter: approx. 1.5 mA at 0.01 - 1(6) A

Ambient Conditions

Operating temperature	-25 ... +55 °C
Storage temperature	-25 ... +70 °C
Relative humidity	Max. 95%, no condensation allowed Max. 75% annual average and non-condensing
Elevation	Up to 2000 m
Place of use	Indoors

Electrical Safety

Pollution degree	2
Protection class	II

Multifunctional Energy Meters

EM2281/EM2289/EM2381/EM2387/EM2389

Insulating group	II
Utilization category (electrical switchgear)	(only for meters with direct connection) UC-2 (per EN 60947)
Nominal insulation voltage	Inputs: 300 V _{AC} Output: 50 V _{DC} (bus/SO) with V0, V1, V2, V7, V8, V9 230 V _{AC} (pulse) with V3, V4
Insulation test voltage	Input ↔ output/housing: 4 kV _{AC} Output ↔ housing: 500 V (bus/SO) with V0, V1, V2, V7, V8, V9 4 kV (pulse) with V3, V4
Overload capacity	All meters: continuous 1.15 U _r and I _{max} Direct connection: 5 × 3 s, U _r and 100 A (5 min. interval) Direct connection: 1 × 1 s, U _r and 250 A, 10 ms 2400 A Current transformer connection: 0.5 s and 20 × I _{max}
Overvoltage category	III (per EN 62052-31) 230 (400) V _{AC} , 289 (500) V _{AC}
Rated impulse voltage	4 kV with basic insulation and 6 kV with reinforced insulation

Electromagnetic Compatibility (EMC)

Interference emission	EN 55022 class B
Interference immunity	EN 61326-1
Electromagnetic classification	E2

Mechanical Design

Mechanical classification	M1
Protection	Front (panel-mount instrument): IP 51 (protection against ingress of solid foreign objects; protected against harmful amounts of dust, protection against ingress of water: protection against dripping water) Terminals: IP 20 (protection against ingress of solid foreign objects: ≥ 12.5 mm dia., protection against ingress of water: not protected) (per EN 60529 / IEC 60529)
Housing (W × H × D)	4 standard width units, approx. 72 × ≤ 90 × ≤ 70 mm
Housing material	Lexan polycarbonate per UL94 V0
Weight	< 0.3 kg
Mounting	Top-hat rail per EN 50022 (35 × 15 or 35 × 7.5 mm), Snap-on C rail
Screw terminals	Slotted screw, 16 mm ² cross-section
Display	LCD, approx. 28 × 42 mm, 7-segment characters (0 ... 99999999 digits) 1 main display: max. 8-place, height: 5.6 mm, 2 auxiliary displays: 8-place, height: 5 mm Refresh: approx. 6 times per second
Protection against tampering	Tamper-proof cover, configuration disabling

Display

Main display (active energy* in kWh or MWh) (M2/M3: reactive energy* in kVArh or MVAh)

Auxiliary display 1 (active power* in kW or MW) (M2/M3: reactive energy or power in kVAr(h) or MVA(h)*)

Auxiliary display 2 (e.g. IN, OUT for import or export)

In case of error: error code alternates with momentary display
* Transformer meter EM238x: CT and VT are taken into consideration.
Power: negative sign for export

Dimensional Drawing / Installation

Top-hat rail per EN 50022 or snap-on rail with C profile

Dimensions each:
35 × 15 mm or
35 × 7.5 mm

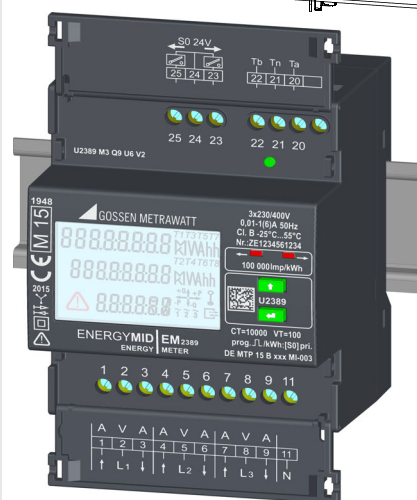
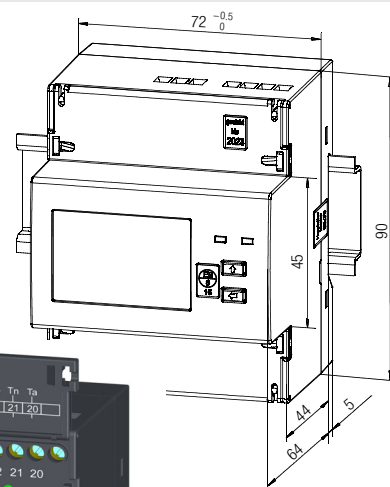

Example:
EM2389 with Open
Terminal Covers

Interfaces

The energy meters are equipped with two pulse outputs or one bus output as a standard feature.

Pulse output	Model and feature-dependent, as well as optional: S0 standard, calibrated, 1000 pulses per kWh (V1) / S0 programmable, 1 ... 1000 pulses per kWh sec. (V2 with EM2281, EM2289) / S0 programmable, 1 ... 50,000 pulses per kWh sec. (V2 with EM2381, EM2387, EM2389) / Switching output up to 230 V, calibrated, 1000 pulses per kWh (V3)/ Switching output up to 230 V, programmable, 1 ... 1000 pulses per kWh (V4 with EM2281, EM2289) / Switching output up to 230 V, programmable, 1 ... 50,000 pulses per kWh (V4 with EM2381, EM2387, EM2389) / S0 130 ms, calibrated, 100 pulses per kWh (V7 with EM2281, EM2289) / S0 130 ms, calibrated, 100 pulses per kWh, in combination with Q9 depending on CT × VT (V7 with EM2381, EM2387, EM2389) / S0 130 ms, calibrated, 1000 pulses per kWh (V8) / Customer-specific S0, calibrated (V9) Pulse duration: 30 ms (adjustable up to 3 s with V2, V4) Interpulse period > 30 ms U _{ext} : max. 40 V (375 V with V3, V4) Switching current: max. 27 mA (100 mA with V3, V4) 1 of 4 pulse sources can be selected for each output: active energy import, active energy export, reactive energy import or reactive energy export. The pulse outputs are electrically isolated from the measuring circuit by means of an optocoupler.
Bus connection	Optional: LON (W1) / M-Bus (W2) / Modbus RTU (W7) / TCP/IP (BACnet, Modbus TCP, HTTP) (W4) ¹⁾
Tariff interface	4 tariffs (hardware controlled) and optionally 4 additional tariffs via bus ²⁾ Power utility pulse

¹⁾ For detailed information refer to the interface description which can be accessed at <https://www.gmc-instruments.de/services/download-center/>.

ENERGYMID

Multifunctional Energy Meters

EM2281/EM2289/EM2381/EM2387/EM2389

²⁾ The 4 additional tariffs via bus are not included in the scope of MID approval.

Connections

Wiring Diagrams – Pulse Output

Feature V1 / V2 / V7 / V8 / V9:

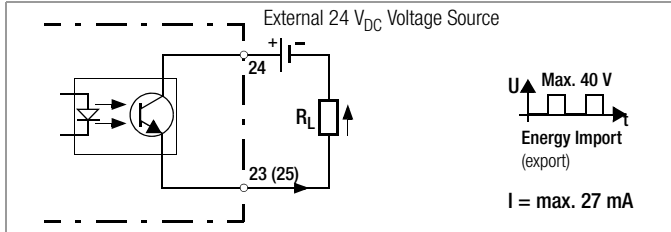

Feature V3 / V4:

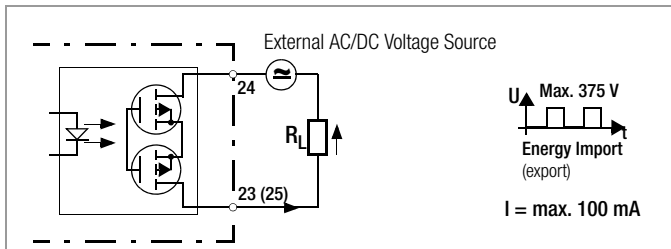

Type of energy can also be selected with feature V2/V4. The default setting is active energy import (23) / export (25).

Mechanical Design

All connection elements are laid out as self-locking screw terminals (slotted screws, 16 mm² cross-section), except for the TCP/IP interface which is equipped with an RJ-45 connector.

Connection	Direct	Transformer
Current input	Fine wire: 6 to 16 mm ² Solid wire: 6 to 25 mm ² With wire end ferrule: 6 to 16 mm ² Torque: 3 Nm	Fine wire: 0.5 to 4 mm ² Solid wire: 0.5 to 6 mm ² With wire end ferrule: 0.5 to 2.5 mm ² Torque: 0.5 Nm
Voltage input	–	Fine wire: 0.5 to 4 mm ² Solid wire: 0.5 to 6 mm ² With wire end ferrule: 0.5 to 2.5 mm ² Torque: 0.5 Nm
S0 pulse output, bus output, tariff input (power utility pulse)	Fine wire: 0.2 to 2.5 mm ² Solid wire: 0.2 to 2.5 mm ² With wire end ferrules: 0.25 to 1.5 mm ² Torque: 0.4 Nm	
LON (W1)*	Twisted pair copper cable, recommended: JY (ST) Y 2 × 2 × 0.8 mm with twisted wire pairs (where 0.8 mm = wire diameter, wire cross-section = 0.5 mm ²), maximum cable length of 900 m with bus topology (bus terminator at both ends), 500 m with free topology (bus terminator at one end) or 320 m from device to device	
M-Bus *	2-wire twisted-pair	
TCP/IP (W4) *	RJ-45 (8P8C)	
Modbus (W7) *	2-wire twisted-pair, shielded if possible, maximum length of 1000 m (depending on cable thickness and transmission speed), cross-section of at least 0.22 mm ² , wave impedance approx. 100 to 150 Ω, terminating resistors at both ends (the following applies: resistance value = line impedance)	

* For detailed information refer to the interface description which can be accessed at <https://www.gmc-instruments.de/services/download-center/>.

Wiring Diagrams – Current and Voltage

EM2281 – Direct Connection
2-Wire System, Any Load

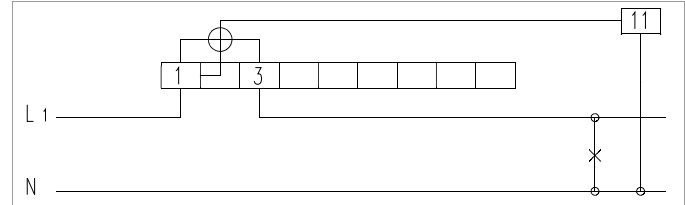

EM2289 – Direct Connection
4-Wire System, Any Load

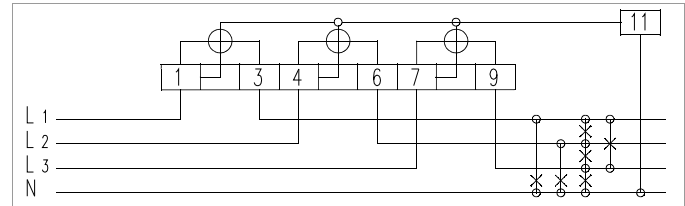

EM2381 – Transformer Connection
2-Wire System, Any Load

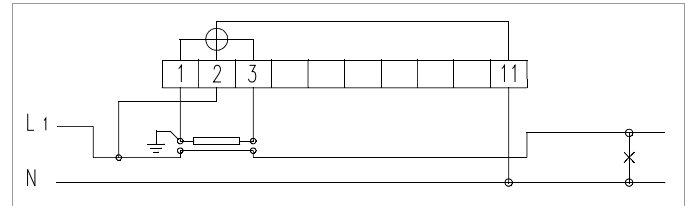

EM2387 – Transformer Connection
3-Wire System, Any Load

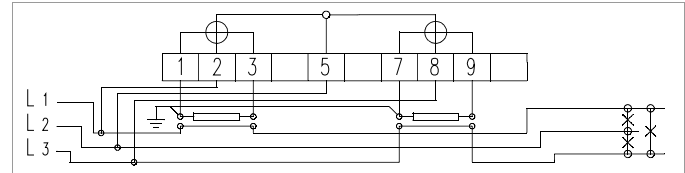

EM2389 – Transformer Connection
4-Wire System, Any Load

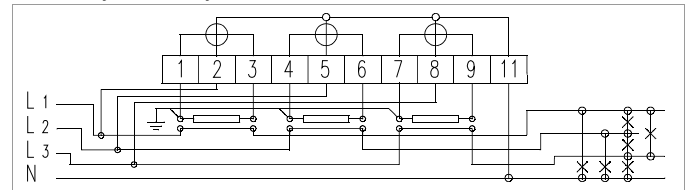

ENERGYMID

Multifunctional Energy Meters

EM2281/EM2289/EM2381/EM2387/EM2389

Order Information

Designation		Article Number / Feature				
EM2281 energy meter for 2-wire system, 230 V, direct connection, 5(80) A		U2281				
EM2289 energy meter for 4-wire system, any load, direct connection, 5(80) A			U2289			
EM2381 energy meter for 2-wire system, 230 V, transformer connection, 1(6) A (including 5(6) A)				U2381		
EM2387 energy meter for 3-wire system, any load, transformer connection, 1(6) A (including 5(6) A)					U2387	
EM2389 energy meter for 4-wire system, any load, transformer connection, 1(6) A (including 5(6) A)						U2389
Multifunctional version / display	None	M0	M0	M0	M0	M0
	With U, I, P, Q, S, PF, f, THD, I _N	M1	M1	M1	M1	M1
	With reactive energy ¹	M2	M2	M2	M2	M2
	With U, I, P, Q, S, PF, f, THD, I _N , reactive energy ¹	M3	M3	M3	M3	M3
Reference voltage U _n	100 ... 110 V L-L	—	—	—	U3	U3
	230 V L-N	U5	—	U5	—	—
	400 V L-L	—	U6	—	U6	U6
	500 V L-L	—	—	—	U7	—
MID approval with declaration of conformity	MID approval	P0	P0	P0	P0	P0
	MID approval and calibration certificate	P9	P9	P9	P9	P9
Pulse output	None (only with bus connection)	V0	V0	V0	V0	V0
	Calibratable 1000 pulses per kWh ²	S0 standard ³	V1	V1	V1	V1
Programmable rate: 1 ... 1000 pulses per kWh sec.	S0, programmable ³	V2	V2	—	—	—
Programmable rate: 1 ... 50,000 pulses per kWh sec. ²	S0, programmable ³	—	—	V2	V2	V2
Calibratable switching output up to 230 V, 1000 pulses per kWh ²	230 V standard ³	V3	V3	V3	V3	V3
Switching output up to 230 V, programmable rate ¹ ... 1000	230 V, programmable ³	V4	V4	—	—	—
Switching output up to 230 V, programmable rate ² 1 ... 50,000	230 V, programmable ³	—	—	V4	V4	V4
Calibratable, 100 pulses per kWh	S0, 130 ms, 100 pulses per kWh ³	V7	V7	—	—	—
Calibratable, 100 pulses per kWh, depends on CT x VT with Q9	S0, 130 ms, 100 pulses per kWh ³	—	—	V7	V7	V7
Calibratable, 1000 pulses per kWh, not with Q9	S0, 130 ms, 1000 pulses per kWh ³	—	—	V8	V8	V8
Calibratable 2000, 5000, 10,000 pulses per kWh	Customer-specific S0 ³ not with Q9	—	—	V9	V9	V9
VTA: Entry for S0 100 ... 20,000 (with U6 or U7)				—	VTA = _____	VTA = _____
VTB: Entry for S0 100 ... 50,000 (with U5)				VTB = _____	—	—
VTC: Entry for S0 100 ... 50,000 (with U3)				—	VTC = _____	VTC = _____
Bus connection	None (only with pulse output)	W0	W0	W0	W0	W0
	LON ⁴	W1	W1	W1	W1	W1
	M-Bus ⁴	W2	W2	W2	W2	W2
	TCP/IP ⁴ (BACnet ⁴ , Modbus TCP, HTTP)	W4	W4	W4	W4	W4
	Modbus RTU ⁴	W7	W7	W7	W7	W7
Transformer ratios	Fixed current/voltage, calibrated main display	CT=VT=1	—	—	Q0	Q0
	Programmable current/voltage, calibrated secondary display	Programmable CT, VT (CT × VT ≤ 100,000)	—	—	Q1	Q1
	Fixed current/voltage, calibrated main display QCT = 1 ... 10,000, QVT = 1 ... 1000, CT×VT ≤ 1 million	Fixed CT, VT	—	—	Q9	Q9
				QCT = _____	QCT = _____	QCT = _____
				QVT = _____	QVT = _____	QVT = _____
Meter reading profile	None	Z0	Z0	Z0	Z0	Z0
	Included (only with bus connection)	Z1	Z1	Z1	Z1	Z1
	With certification per PTB-A 50.7 (only in combination with W4, not possible in combination with U3)	Z2	Z2	Z2	Z2	Z2

¹ Not approved in Switzerland

² In the case of the U238x and Q9, pulse rates are read out with reference to the primary winding:

Pulse Rate Table	for V1 and V3, calibrated	V7	For V2 and V4, not calibrated
CT x VT	Fixed		Programmable
2 ... 10	1000 pulses per kWh	100	1 ... 1000 pulses per kWh
11 ... 100	100 pulses per kWh	10	0.1 ... 100 pulses per kWh
101 ... 1000	10 pulses per kWh	1	0.01 ... 10 pulses per kWh
1001 ... 10,000	1000 pulses per MWh	100	1 ... 1000 pulses per MWh
10001 ... 100000	100 pulses per MWh	10	0.1 ... 100 pulses per MWh
100001 ... 1000000	10 pulses per MWh	1	

³ Cannot be ordered in combination with W1 ... W7

⁴ Cannot be ordered in combination with V1 ... V9

Feature Q1 (only secondary display is calibrated)

Only secondary values (menu selection) may be used for billing purposes.

Sample Order

4-wire system, any load, with reactive energy measurement, with MID approval, programmable transformation ratio, input voltage: 400 V, with standard S0 pulse output, no bus connection, no meter reading profile

Designation: U2389 M2 P0 Q1 U6 V1 W0 Z0

ENERGYMID

Multifunctional Energy Meters

EM2281/EM2289/EM2381/EM2387/EM2389

Standard Meters with MID Approval and Initial Calibration (available from stock)

Direct Connection, 5(80) A, class B, MID for 4-wire system, 3 × 230 / 400 V	Feature	Standard (M0)	Multifunctional Variant (M1)
Programmable S0 pulse rate	V2, P0, U6	U2289-V012	U2289-V022
LON	W1, P0, U6	U2289-V013	U2289-V023
M-Bus	W2, P0, U6	U2289-V014	U2289-V024
TCP/IP (BACnet, Modbus TCP, HTTP)	W4, P0, U6	U2289-V017	U2289-V027
TCP/IP with certified meter reading profile	W4, P0, U6, Z2	—	U2289-V047
Modbus RTU	W7, P0, U6	U2289-V018	U2289-V028
Transformer Connection, 5(6) A and 1(6) A, class B, MID for 3-wire system, 3 × 230 / 400 V, programmable CT / VT			
Feature	Standard (M0)	Multifunctional Variant (M1)	
Programmable S0 pulse rate	V2, P0, U6, Q1	U2387-V012	U2387-V022
Transformer Connection, 5(6) A and 1(6) A, class B, MID for 4-wire system, 3 × 230 / 400 V, programmable CT / VT			
Feature	Standard (M0)	Multifunctional Variant (M1)	
Programmable S0 pulse rate	V2, P0, U6, Q1	U2389-V011	U2389-V021
LON	W1, P0, U6, Q1	U2389-V016	U2389-V026
M-Bus	W2, P0, U6, Q1	U2389-V015	U2389-V025
TCP/IP (BACnet, Modbus TCP, HTTP)	W4, P0, U6, Q1	U2389-V017	U2389-V027
TCP/IP with certified meter reading profile	W4, P0, U6, Z2	—	U2389-V047
Modbus RTU	W7, P0, U6, Q1	U2389-V018	U2389-V028

Abbreviations and Their Meanings

Icon	Meaning
CT	Current transformation ratio
CT × VT	Product of CT times VT
EP ₁ ...EP ₈ , EP _{tot}	Active energy per tariff and total (across all phases)
EQ ₁ ...EQ ₈ , EQ _{tot}	Reactive energy per tariff and total (across all phases)
f	Frequency
I ₁ , I ₂ , I ₃	Current per phase (TRMS value)
I _N	Neutral conductor current (calculated)
I _{max}	Limit current
I _{min}	Minimum current value
I _{ref}	Reference current (value)
M0 (feature)	Without multifunctional variant
M1 (feature)	Multifunctional variant: Measurement of U, I, P, Q, S, PF, f, THD, I _N
M2 (feature)	Measurement of reactive energy
M3 (feature)	Multifunctional variant: Measurement of U, I, P, Q, S, PF, f, THD, I _N , reactive energy
P ₁ , P ₂ , P ₃ , P _{tot}	Active power, per phase and total
PF ₁ , PF ₂ , PF ₃ , PF _{tot}	Power factor (cosφ) per phase and total
P0 (feature)	MID approval
P9 (feature)	MID approval and calibration certificate
Q ₁ , Q ₂ , Q ₃ , Q _{tot}	Reactive power, per phase and total
Q1 (feature)	Programmable transformation ratios
Q9 (feature)	Fixed transformation ratios
S ₁ , S ₂ , S ₃ , S _{tot}	Apparent power, per phase and total
S0	Pulse rate, S0 output

Icon	Meaning
THD I ₁ , I ₂ , I ₃	Current distortion component per phase (TRMS value), THD – total harmonic distortion
THD U ₁ , U ₂ , U ₃	Voltage distortion component per phase (TRMS value), THD – total harmonic distortion
U _n	Reference voltage
U _{1N} , U _{2N} , U _{3N}	Star voltage (RMS)
U ₁₂ , U ₂₃ , U ₁₃	Delta voltage (RMS)
U3 (feature)	Reference voltage: 100 ... 110 V L–L
U5 (feature)	Reference voltage: 230 V L–N
U6 (feature)	Reference voltage: 400 V L–L
U7 (feature)	Reference voltage: 500 V L–L
V0 (feature)	Without pulse output
V1 (feature)	Pulse output
V2/V4 (feature)	Programmable S0
V9 (feature)	Customer-specific S0 rate
VT	Voltage transformation ratio
W0 (feature)	Pulse output only (without bus connection)
W1 (feature)	LON-Bus
W2 (feature)	M-Bus
W4 (feature)	TCP/IP (BACnet, Modbus TCP, HTTP)
W7 (feature)	MODBUS RTU
Z0 (feature)	Without meter reading profile
Z1 (feature)	Meter reading profile (only possible with bus connection)
Z2 (feature)	Certified meter reading profile per PTB-A 50.7 (only in combination with W4, not possible in combination with U3)

ENERGYMID

Multifunctional Energy Meters

EM2281/EM2289/EM2381/EM2387/EM2389

Comparison of Energy Meters with MID Approval

Various MID-certified energy meters are included in the portfolio offered by Gossen Metrawatt GmbH: the new ENERGYMID energy meter generation (the products described in this data sheet) and the ENERGYMETER MID. The following table compares the scope of features of the different meters so that you can find the most suitable instrument for your application.

Meter Family		MID Energy Meters ¹					ENERGYMID EM				
Nominal current (current limit value)		5 (65) A		1(6) A (including 5(6) A)			5 (80) A		1(6) A (including 5(6) A)		
Mains type	2-wire system	U1281		U1381			EM2281		EM2381		
	3-wire system				U1387					EM2387	
	4-wire system		U1289			U1389		EM2289			EM2389
Connection	Direct	✓	✓	—	—	—	✓	✓	—	—	—
	Via transformer	—	—	✓	✓	✓	—	—	✓	✓	✓
Input voltage	100 ... 110 V L-L	—	—	—	✓	✓	—	—	—	✓	✓
	230 V L-N	✓	—	✓	—	—	✓	—	✓	—	—
	400 V L-L	—	✓	—	✓	✓	—	✓	—	✓	✓
	500 V L-L	—	—	—	✓	—	—	—	—	✓	—
4-quadrant measurement		—	—	—	—	—	✓	✓	✓	✓	✓
LCD panel	1 main and 1 auxiliary display	✓	✓	✓	✓	✓	—	—	—	—	—
	1 main and 2 auxiliary displays	—	—	—	—	—	✓	✓	✓	✓	✓
Layout	Housing width	125.5 mm (7 standard width units)					72 mm (4 standard width units)				
Pulse output		1 pulse output					2 pulse outputs				
	S0, standard, calibrated	✓	✓	✓	✓	✓	Optional	Optional	Optional	Optional	Optional
	Programmable S0	✓	✓	✓	✓	✓	Optional	Optional	Optional	Optional	Optional
	230 V, standard, calibrated	✓	✓	✓	✓	✓	Optional	Optional	Optional	Optional	Optional
	230 V, programmable	✓	✓	✓	✓	✓	Optional	Optional	Optional	Optional	Optional
	Customer-specific S0, calibrated	✓	✓	✓	✓	✓	Optional	Optional	Optional	Optional	Optional
Transformer ratios	CT = VT = 1, main display for secondary, calibrated	—	—	✓	✓	✓	—	—	✓	✓	✓
	CT, VT programmable aux. display for secondary	—	—	Optional	Optional	Optional	—	—	Optional	Optional	Optional
	Fixed CT, VT, main display for primary, calibrated	—	—	Optional	Optional	Optional	—	—	Optional	Optional	Optional
Approval	MID	✓	✓	✓	✓	✓	✓	✓	✓	✓	✓
	MID and calibration certificate	Optional	Optional	Optional	Optional	Optional	Optional	Optional	Optional	Optional	Optional
Options											
Multifunctional variants	U, I, P, Q, S, PF, f	Optional	Optional	Optional	Optional	Optional	Optional	Optional	Optional	Optional	Optional
	Reactive energy	Optional	Optional	Optional	Optional	Optional	Optional	Optional	Optional	Optional	Optional
	THD, In	—	—	—	—	—	Optional	Optional	Optional	Optional	Optional
Bus connection	LON	Optional	Optional	Optional	Optional	Optional	Optional	Optional	Optional	Optional	Optional
	M-Bus	Optional	Optional	Optional	Optional	Optional	Optional	Optional	Optional	Optional	Optional
	TCP/IP (BACnet, Modbus TCP, HTTP)	—	—	—	—	—	Optional	Optional	Optional	Optional	Optional
	Modbus RTU	—	—	—	—	—	Optional	Optional	Optional	Optional	Optional
Tariffs	4 tariffs (hardware controlled)	—	—	—	—	—	✓	✓	✓	✓	✓
	4 additional tariffs via bus ²	—	—	—	—	—	Optional	Optional	Optional	Optional	Optional
24 V DC external auxiliary power		Optional	Optional	Optional	Optional	Optional	—	—	—	—	—
Meter reading profile		—	—	—	—	—	Optional	Optional	Optional	Optional	Optional
Certified meter reading profile (PTB-A 50.7)		—	—	—	—	—	Optional	Optional	Optional	Optional	Optional

¹ See separate data sheet for order information: U1281/U1289/U1381/U1387/U1389

² Not included in scope of MID approval